

## Table of Contents

<b>Introduction</b>	<b>4</b>
<b>Instrument Cluster</b>	<b>14</b>
Warning lights and chimes	14
Gauges	18
<b>Entertainment Systems</b>	<b>20</b>
AM/FM stereo cassette with CD	20
AM/FM stereo with in-dash six CD	25
Navigation system	36
<b>Climate Controls</b>	<b>74</b>
Manual heating and air conditioning	74
Rear window defroster	75
<b>Lights</b>	<b>76</b>
Headlamps	76
Turn signal control	80
Bulb replacement	82
<b>Driver Controls</b>	<b>86</b>
Windshield wiper/washer control	86
Steering wheel adjustment	87
Power windows	90
Mirrors	92
Speed control	92
Moon roof	95
Message center	96
<b>Locks and Security</b>	<b>109</b>
Keys	109
Locks	109
Anti-theft system	117

## Table of Contents

<b>Seating and Safety Restraints</b>	<b>121</b>
Seating	121
Safety restraints	129
Airbags	143
Child restraints	158
<b>Tires, Wheels and Loading</b>	<b>170</b>
Tire Information	172
Tire Inflation	174
Tire Pressure Monitoring System (TPMS)	187
Vehicle loading	191
Trailer towing	197
Recreational towing	202
<b>Driving</b>	<b>203</b>
Starting	203
Brakes	206
Transmission operation	210
<b>Roadside Emergencies</b>	<b>222</b>
Getting roadside assistance	222
Hazard flasher switch	223
Fuel pump/High voltage shut-off switches	224
Fuses and relays	225
Changing tires	232
Lug Nut Torque	243
Jump starting	244
Wrecker towing	251
<b>Customer Assistance</b>	<b>253</b>
Reporting safety defects (U.S. only)	259
<b>Cleaning</b>	<b>260</b>

## Table of Contents

<b>Maintenance and Specifications</b>	<b>267</b>
Engine compartment	270
Engine oil	272
Battery	275
Fuel information	283
Air filter(s)	297
Part numbers	299
Maintenance product specifications and capacities	300
Engine data	302
<b>Accessories</b>	<b>305</b>
<b>Scheduled Maintenance Guide</b>	<b>307</b>
Normal Scheduled Maintenance and Log	311
Special Operating Conditions and Log	325
<b>Index</b>	<b>331</b>

All rights reserved. Reproduction by any means, electronic or mechanical including photocopying, recording or by any information storage and retrieval system or translation in whole or part is not permitted without written authorization from Ford Motor Company. Ford may change the contents without notice and without incurring obligation.

Copyright © 2006 Ford Motor Company

## Introduction

### CALIFORNIA Proposition 65 Warning



**WARNING:** Engine exhaust, some of its constituents, and certain vehicle components contain or emit chemicals known to the State of California to cause cancer and birth defects or other reproductive harm. In addition, certain fluids contained in vehicles and certain products of component wear contain or emit chemicals known to the State of California to cause cancer and birth defects or other reproductive harm.

### CONGRATULATIONS

Congratulations on acquiring your new Ford Escape Hybrid. Please take the time to get well acquainted with your vehicle by reading this handbook. The more you know and understand about your vehicle, the greater the safety and pleasure you will derive from driving it.

For more information on Ford Motor Company and its products visit the following website:

- In the United States: [www.ford.com](http://www.ford.com)
- In Canada: [www.ford.ca](http://www.ford.ca)

Additional owner information is given in separate publications.

This *Owner's Guide* describes every option and model variant available and therefore some of the items covered may not apply to your particular vehicle. Furthermore, due to printing cycles it may describe options before they are generally available.

Remember to pass on this *Owner's Guide* when reselling the vehicle. It is an integral part of the vehicle.



**Fuel pump and high voltage battery shut-off switches:** In the event of an accident the fuel pump shut-off switch may automatically cut off the fuel supply to the engine and the high voltage shut-off switch cuts off power from the high voltage battery. These switches can also be activated through sudden vibration (e.g. collision when parking). For information on resetting the fuel pump shut-off switch and the high voltage battery shutoff switch, refer to the *Fuel pump/high voltage shut-off switches* in the *Roadside Emergencies* chapter.

## Introduction

### SAFETY AND ENVIRONMENT PROTECTION

#### **Warning symbols in this guide**

How can you reduce the risk of personal injury to yourself or others? In this guide, answers to such questions are contained in comments highlighted by the warning triangle symbol. These comments should be read and observed.

#### **Warning symbols on your vehicle**

When you see this symbol, it is imperative that you consult the relevant section of this guide before touching or attempting adjustment of any kind.



#### **Protecting the environment**

We must all play our part in protecting the environment. Correct vehicle usage and the authorized disposal of waste, cleaning and lubrication materials are significant steps towards this aim. Information in this respect is highlighted in this guide with the tree symbol.



### BREAKING-IN YOUR VEHICLE

Your vehicle does not need an extensive break-in. Try not to drive continuously at the same speed for the first 1,000 miles (1,600 km) of new vehicle operation. Vary your speed frequently in order to give the moving parts a chance to break in.

Drive your new vehicle at least 500 miles (800 km) before towing a trailer. For more detailed information about towing a trailer, refer to *Trailer towing* in the *Tires, Wheels and Loading* chapter.

Do not add friction modifier compounds or special break-in oils since these additives may prevent piston ring seating. See *Engine oil* in the *Maintenance and Specifications* chapter for more information on oil usage.

### NORMAL VEHICLE OPERATION

Your Escape Hybrid has unique qualities which cause it to operate differently than a typical vehicle.

## Introduction

### Starting the vehicle

- The engine will start and run when you first turn the ignition key to the start position.
- The engine cannot be started in the N (Neutral) position.
- Depending upon temperature and the high voltage battery's state of charge, the engine may shut off shortly after starting the vehicle; this is a normal condition and you do not need to restart the vehicle. The Ready Indicator Light in the instrument cluster will illuminate to indicate the vehicle is running. For more Ready Indicator Light information, refer to *Warning lights and chimes* in the *Instrument Cluster* chapter.

### DRIVING THE VEHICLE

#### Starting Out:

Under normal operation with the vehicle at operating temperature, the engine will start automatically as you accelerate. Sometimes the engine will start immediately as you begin moving, while other times the vehicle will obtain a speed of up to 25 mph (40 km/h) before the engine starts. You may hear and feel the engine starting as you transition from electrical to hybrid (gas engine on) operation. This is a normal condition.

These are some of the conditions that may cause engine start-up:

- High voltage battery re-charge is required.
- Driver acceleration demands exceed electric motor capability.
- Outside air temperature is overly hot or cold.
- Certain climate system modes of operation.
- If you are starting up hill or accelerating quickly, the engine will start immediately as operating conditions require additional power.

**Note:** If the high voltage battery is very cold or very hot, the engine may operate more than under normal conditions, and vehicle performance may be temporarily reduced. This is a normal condition.

#### Transmission operation

- Your vehicle does not shift like a conventional vehicle. You may feel transitions between the various operating modes of the hybrid system, but no actual shifting occurs. For more information about transmission operation, refer to *Understanding the gearshift positions of the electronically-controlled Continuously Variable Transaxle (eCVT)* in the *Driving* chapter.

## Introduction

### Stopping the vehicle

- The vehicle's engine may shut off as you come to a stop; this is a normal condition and helps to conserve fuel. You do not need to restart the vehicle.

### Neutral operation

- The vehicle does not charge the high voltage battery in the N (Neutral) position. Do not idle the vehicle in N (Neutral) for extended periods as this will discharge the high voltage battery.

### Low gear operation

- In L (Low) gear, you may feel an increased sensation of engine braking as you remove your foot from the accelerator. L (Low) gear can be helpful when driving down an incline; unlike in a conventional vehicle, L (Low) does not offer an advantage over D (Drive) in uphill or off-road driving conditions.

### Reverse operation

- Vehicle speed is limited to 22 mph (35 km/h) while operating in R (Reverse) gear.

## ESCAPE HYBRID UNIQUE OPERATING CHARACTERISTICS

- You may hear some unique sounds from a hybrid vehicle. The Escape Hybrid is equipped with a high voltage battery air conditioning system in the rear of the vehicle which cools the high voltage battery in order to ensure high voltage battery life and optimize performance. You may hear a slight clunk or tap noise as the vent door operates, as well as a fan noise in the rear of the vehicle; this noise is the high voltage battery cooling fan. The high voltage battery cooling may also continue to operate for short durations after the vehicle has been turned off. These vehicle conditions and noises are normal and do not require service.
- You may hear a pumping sound when you enter the vehicle or a venting sound a few minutes after parking the vehicle. This is due to charging and discharging of the hydraulic portion of the regenerative braking system.
- You may hear a slight whine or whistle when operating your vehicle. This noise could occur at idle, and during cruising and accelerating; it is caused by the normal operation of electrical generator in the hybrid system.



## Introduction

- The Escape Hybrid's hydraulic brake system used for regenerative braking is different from other vehicles. The noise from the ABS pump motor and the brake pedal pulsation are much less than on vehicles with conventional ABS. Noise and pedal pulsation during ABS may not be noticed. For more information about braking, refer to *Braking* in the *Driving* chapter.
- The engine speed in an Escape Hybrid is not directly tied to the vehicle speed. Under certain conditions, the engine speed may appear much higher than that of a conventional automobile. This is a normal condition and is caused by engine speed optimization to maximize fuel economy.
- During certain events (such as vehicle servicing) your low voltage (underhood) battery may become disconnected or disabled. When this occurs, and after reconnecting the low voltage (underhood) battery and driving the vehicle, the engine may continue to operate for 3-5 seconds after the key is turned to the 1 (LOCK) position. This is a normal condition, as the vehicle's computers are relearning the operating characteristics of your particular engine in order to operate it at maximum efficiency.
- The high voltage battery may go through a self-reconditioning process from time to time; these events optimize high voltage battery performance. You may notice slight changes to driveability during the reconditioning process. This is a normal condition.
- If the vehicle is left inoperative for over 31 days, it may be necessary to jumpstart the vehicle. For more information, refer to *Jump starting your vehicle (Low voltage [underhood] battery only)* in the *Roadside Emergencies* chapter.

### DRIVING TO OPTIMIZE FUEL ECONOMY

Fuel economy can be significantly impacted by your driving habits and accessory usage. To optimize the fuel economy in your vehicle, please be aware of the following vehicle functions which affect fuel economy:

#### A/C operation

- With the climate control system set to MAX A/C, defrost, or defrost/floor mode (the orange graphics on your climate control), the engine will typically run continuously, reducing fuel economy. Setting the climate control system to A/C mode or A/C  mode also reduces fuel economy, but in this case the A/C only operates when the engine is already running due to other demands. Because the engine does not run continuously, A/C and A/C  mode are more fuel efficient than MAX A/C mode.



## Introduction

### Driver habits

- In general, better fuel economy is achieved during moderate acceleration and deceleration as opposed to aggressive acceleration and deceleration. This is true regardless of the mode in which you're operating your vehicle.
- To maximize fuel economy, try to extend the length of time the vehicle operates in electric mode by accelerating lightly. The more you keep the vehicle in electric mode, the better fuel economy you will achieve.
- For more information on improving the fuel economy of your Escape Hybrid, refer to *Essentials of good fuel economy* in the *Maintenance and Specifications* chapter.

### SPECIAL NOTICES

#### New Vehicle Limited Warranty

For a detailed description of what is covered and what is not covered by your vehicle's New Vehicle Limited Warranty, refer to the *Warranty Guide* that is provided to you along with your *Owner's Guide*.

#### Special instructions

For your added safety, your vehicle is fitted with sophisticated electronic controls.



Please read the section *Supplemental restraint system (SRS)* in the *Seating and Safety Restraints* chapter. Failure to follow the specific warnings and instructions could result in personal injury.



Front seat mounted rear-facing child or infant seats should **NEVER** be placed in front of an active passenger airbag.

#### Service Data Recording

Service data recorders in your vehicle are capable of collecting and storing diagnostic information about your vehicle. This potentially includes information about the performance or status of various systems and modules in the vehicle, such as engine, throttle, steering or brake systems. In order to properly diagnose and service your vehicle, Ford Motor Company, Ford of Canada, and service and repair facilities may access vehicle diagnostic information through a direct connection to your vehicle when diagnosing or servicing your vehicle.

## Introduction

### **Event Data Recording**

Other modules in your vehicle — event data recorders — are capable of collecting and storing data during a crash or near crash event. The recorded information may assist in the investigation of such an event. The modules may record information about both the vehicle and the occupants, potentially including information such as:

- how various systems in your vehicle were operating;
- whether or not the driver and passenger seatbelts were buckled;
- how far (if at all) the driver was depressing the accelerator and/or the brake pedal;
- how fast the vehicle was traveling; and
- where the driver was positioning the steering wheel.

To access this information, special equipment must be directly connected to the recording modules. Ford Motor Company and Ford of Canada do not access event data recorder information without obtaining consent, unless pursuant to court order or where required by law enforcement, other government authorities or other third parties acting with lawful authority. Other parties may seek to access the information independently of Ford Motor Company and Ford of Canada.

### **Notice to owners of pickup trucks and utility type vehicles**



Utility vehicles have a significantly higher rollover rate than other types of vehicles.

Before you drive your vehicle, please read this *Owner's Guide* carefully. Your vehicle is not a passenger car. As with other vehicles of this type, failure to operate this vehicle correctly may result in loss of vehicle control, vehicle rollover, personal injury or death.

Be sure to read *Driving off road* in the *Driving* chapter.

### **Using your vehicle with a snowplow**

#### **Do not use this vehicle for snowplowing.**

Your vehicle is not equipped with a snowplowing package.

### **Using your vehicle as an ambulance**

#### **Do not use this vehicle as an ambulance.**

Your vehicle is not equipped with the Ford Ambulance Preparation Package.

## Introduction

### Cell phone use

The use of Mobile Communications Equipment has become increasingly important in the conduct of business and personal affairs. However, drivers must not compromise their own or others' safety when using such equipment. Mobile Communications can enhance personal safety and security when appropriately used, particularly in emergency situations. Safety must be paramount when using mobile communications equipment to avoid negating these benefits.

Mobile Communication Equipment includes, but is not limited to cellular phones, pagers, portable email devices, in-vehicle communications systems, telematics devices and portable two-way radios.



A driver's first responsibility is the safe operation of the vehicle. The most important thing you can do to prevent a crash is to avoid distractions and pay attention to the road. Wait until it is safe to operate Mobile Communications Equipment.



### Middle East/North Africa vehicle specific information

For your particular global region, your vehicle may be equipped with features and options that are different from the ones that are described in this *Owner's Guide*; therefore, a supplement has been supplied that complements this book. By referring to the pages in the provided supplement, you can properly identify those features, recommendations and specifications that are unique to your vehicle. **Refer to this Owner's Guide for all other required information and warnings.**

## Introduction





















These are some of the symbols you may see on your vehicle.

### Vehicle Symbol Glossary

Safety Alert		See Owner's Guide	
Fasten Safety Belt		Airbag - Front	
Airbag - Side		Child Seat	
Child Seat Installation Warning		Child Seat Lower Anchor	
Child Seat Tether Anchor		Brake System	
Anti-Lock Brake System		Brake Fluid - Non-Petroleum Based	
Powertrain Malfunction		Speed Control	
Master Lighting Switch		Hazard Warning Flasher	
Fog Lamps-Front		Fuse Compartment	
Fuel Pump Reset		Windshield Wash/Wipe	
Windshield Defrost/Demist		Rear Window Defrost/Demist	

## Introduction

### Vehicle Symbol Glossary

Power Windows Front/Rear		Power Window Lockout	
Child Safety Door Lock/Unlock		Interior Luggage Compartment Release Symbol	
Panic Alarm		Engine Oil	
Engine Coolant		Engine Coolant Temperature	
Do Not Open When Hot		Battery	
Avoid Smoking, Flames, or Sparks		Battery Acid	
Explosive Gas		Fan Warning	
Power Steering Fluid		Maintain Correct Fluid Level	
Emission System		Engine Air Filter	
Passenger Compartment Air Filter		Jack	
Check Fuel Cap		Low Tire Pressure Warning	

## Instrument Cluster

### WARNING LIGHTS AND CHIMES

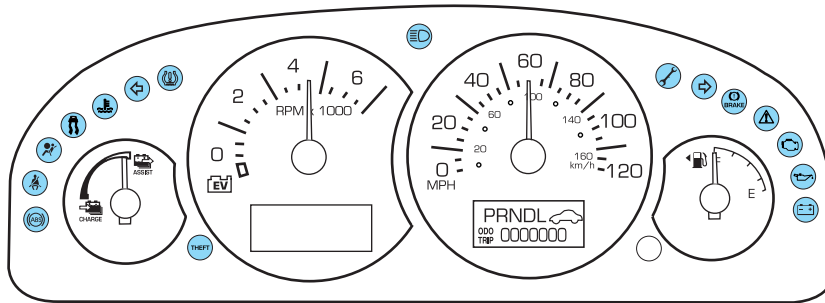

Warning lights and gauges can alert you to a vehicle condition that may become serious enough to cause expensive repairs. A warning light may illuminate when a problem exists with one of your vehicle's functions. Many lights will illuminate when you start your vehicle to test and make sure the bulb works. If any light remains on after starting the vehicle, refer to the respective system warning light for additional information.

**Note:** A message may be displayed in the message center in conjunction with an illuminated warning light, refer to *Message Center* in the *Driver Controls* chapter for more information.

**Service engine soon:** The *Service engine soon* indicator light illuminates when the ignition is first turned to the RUN position to check

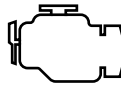

the bulb. Solid illumination after the engine is started indicates the On Board Diagnostics System (OBD-II) has detected a malfunction. Refer to *On board diagnostics (OBD-II)* in the *Maintenance and Specifications* chapter. If the light is blinking, engine misfire is occurring which could damage your catalytic converter. Drive in a moderate fashion (avoid heavy acceleration and deceleration) and have your vehicle serviced immediately by your authorized dealer.



Under engine misfire conditions, excessive exhaust temperatures could damage the catalytic converter, the fuel system, interior floor coverings or other vehicle components, possibly causing a fire.

## Instrument Cluster

**Service soon:** The Service soon indicator illuminates when the vehicle has detected a malfunction. Report the fault to a dealer at the earliest opportunity.



**Brake system warning light:** To confirm the brake system warning light is functional, it will momentarily illuminate when the ignition is turned to the RUN position (when the engine is not running), or in a position between RUN and START, or by applying the parking brake when the ignition is turned to the RUN position. If the brake system warning light does not illuminate at this time, seek service immediately from your authorized dealer. Illumination after releasing the parking brake indicates low brake fluid level and the brake system should be inspected immediately by your authorized dealer.



Driving a vehicle with the brake system warning light on is dangerous. A significant decrease in braking performance may occur. It will take you longer to stop the vehicle. Have the vehicle checked by your authorized dealer.

**Anti-lock brake system (ABS):** If the lamp stays on for more than a few seconds, then an ABS fault is indicated, have the system serviced immediately by your authorized dealer. Normal braking is still functional unless the brake warning light also is illuminated.

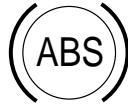

**Airbag readiness:** If this light fails to illuminate when ignition is turned to ON, continues to flash or remains on, have the system serviced immediately by your authorized dealer. A chime will also sound when a malfunction in the supplemental restraint system has been detected.



## Instrument Cluster

**Safety belt:** Reminds you to fasten your safety belt. A chime will also sound to remind you to fasten your safety belt. If this light continues to flash the chime will sound again to remind you to fasten your safety belt.



**Master vehicle electrical hazard warning lamp:** Indicates Hybrid component fault/failure that will cause the vehicle to shutdown or fail to start.



**Note: If the vehicle is still running, the vehicle may soon shutdown without further warning and should be stopped safely.**

If this lamp is lit, stop the vehicle, shift to P (Park), turn the key to the Off position, and attempt to restart the vehicle. If the fault remains, the vehicle may require refueling, jump starting, resetting of the shut-off switches, or service. For information regarding *Low voltage [underhood] battery only*) and *Fuel pump/High voltage shut-off switches* please refer to the *Roadside Emergencies* chapter.

**Charging system:** Illuminates when the 12V charging system is not working properly.



**Ready indicator light:** Illuminates once the vehicle has successfully started. Indicates the vehicle is ready to drive even when you don't hear the engine running.



**Engine oil pressure:** Illuminates when the oil pressure falls below the normal range, refer to *Engine oil* in the *Maintenance and Specifications* chapter.



**Engine or motor electronic coolant temperature:** Illuminates when the coolant temperature exceeds the threshold. When the light is flashing or remains on, stop the vehicle as soon as possible, switch off the engine and let cool. Refer to *Engine or motor electronic coolant* in the *Maintenance and Specifications* chapter.





## Instrument Cluster



Never remove the coolant reservoir cap while the engine is running or hot.

### Low tire pressure warning:

Illuminates when your tire pressure is low. If the light remains ON at start up or while driving, the tire pressure should be checked. Refer to *Inflating Your Tires* in the *Tires, Wheels and Loading* chapter. When the ignition is first turned to ON, the light will illuminate for 3 seconds to ensure the bulb is working. If the light does not turn ON, have the system inspected by your authorized dealer. For more information on this system, refer to *Understanding Your Tire Pressure Monitoring System* in the *Tires, Wheels and Loading* chapter.

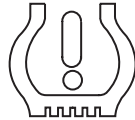

### ABS active/Traction control<sup>™</sup>

**active (if equipped):** Flashes when the ABS system is active. If the light remains on, have the system serviced immediately, refer to the *Driving* chapter for more information.



**Anti-theft system:** Flashes when the SecuriLock<sup>™</sup> Passive Anti-theft System has been activated.

THEFT

**Turn signal:** Illuminates when the left or right turn signal or the hazard lights are turned on. If the indicators stay on or flash faster, check for a burned out bulb.



**High beams:** Illuminates when the high beam headlamps are turned on.



**Key-in-ignition warning chime:** Sounds when the key is left in the ignition in the OFF/LOCK or ACCESSORY position and the driver's door is opened.

**Headlamps on warning chime:** Sounds when the headlamps or parking lamps are on, the ignition is off (the key is not in the ignition) and the driver's door is opened.

## Instrument Cluster

**Turn signal chime (if equipped):** Sounds when the turn signal lever has been activated to signal a turn and not turned off after the vehicle is driven more than 2 miles (3.3 km).

**Transmission not in park chime:** Sounds when the PRNDL is not in P (Park) position, the driver's door is ajar and the ignition is ON.

**HEV Engine off Reminder Chime:** Sounds for 10 seconds when the PRNDL is in the P (Park) position and the Driver's door is ajar (open) while ignition is ON. Always turn your ignition key to Off and remove key before leaving your vehicle. (The engine may be off when the vehicle is stopped, yet the key is on, and the engine can turn on at any time)

**Message center activation chime:** Sounds when a warning message appears in the message center display for the first time.

**Message center switch activation chime:** Sounds when the message center INFO or SET control is pressed.

### GAUGES

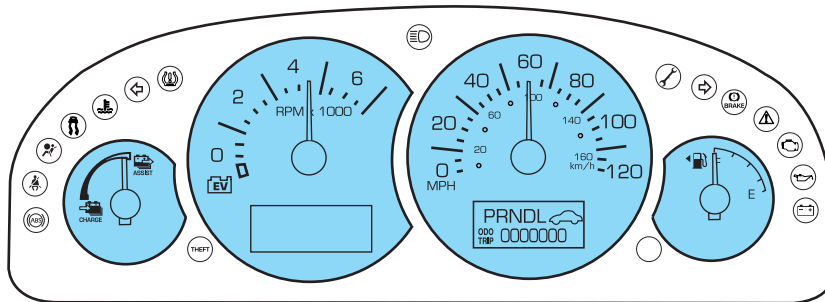

**Speedometer:** Indicates the current vehicle speed.

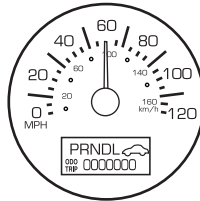

## Instrument Cluster

**Battery gauge:** Provides information about the vehicle's energy usage.

- **ASSIST** — Battery provides extra power to boost the vehicle's acceleration.
- **CHARGE** — Storing extra energy in the battery when coasting or slowing down.

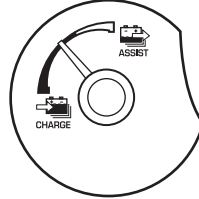

**Odometer:** Registers the total miles (or kilometers) of the vehicle.



**Trip odometer:** Registers the miles (or kilometers) of individual journeys. To reset, press and hold the trip reset button for two or more seconds; this returns the trip odometer to zero. Press and release the button to return to the odometer display.



**Tachometer:** Indicates the engine speed in revolutions per minute. Driving with your tachometer pointer continuously at the top of the scale (in the red zone) may damage the engine. The pointer will indicate engine RPMs when the engine is running and point at the EV symbol when the engine is off and the vehicle is running on pure electrical power.

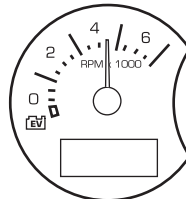

**Fuel gauge:** Indicates approximately how much fuel is left in the fuel tank (when the ignition is in the ON position). The fuel gauge may vary slightly when the vehicle is in motion or on a grade.

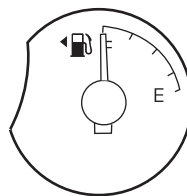

Refer to *Filling the tank* in the *Maintenance and Specifications* chapter for more information.

## Entertainment Systems

### AUDIO SYSTEMS

#### Premium Satellite Compatible AM/FM Stereo/Cassette/Single CD/MP3 (if equipped)

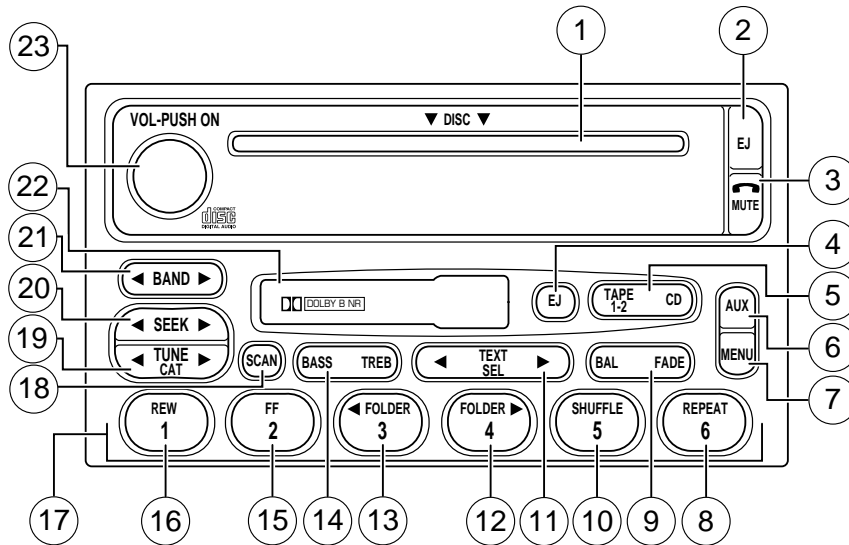

1. **CD slot:** Insert a CD with the label side up.

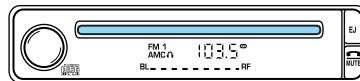

**CD units are designed to play commercially pressed 4.75 in (12 cm) audio compact discs only. Due to technical incompatibility, certain recordable and re-recordable compact discs may not function correctly when used in Ford CD players. Irregular shaped CDs, CDs with a scratch protection film attached, and CDs with homemade paper (adhesive) labels should not be inserted into the CD player. The label may peel and cause the CD to become jammed. It is recommended that homemade CDs be identified with permanent felt tip marker rather than adhesive labels. Ballpoint pens may damage CDs. Please contact your authorized dealer for further information.**

20

2007 Escape Hybrid (ehv)  
Owners Guide (post-2002-fmt)  
USA (fus)

## Entertainment Systems

2. **CD Eject:** Press to eject a CD.  
The radio will resume playing.



3. **Mute:** Press to MUTE playing media; press again to return to the playing media.



4. **Tape Eject:** Press to eject the cassette. The radio will resume playing.



5. **Tape 1-2/CD:** Press to begin tape play. If a cassette is already playing, press to change playing sides.



**CD:** If a CD is loaded in the radio, pressing CD will cause the CD to begin playing.



6. **AUX:** Press to toggle between the current playing media and DVD (if equipped).



7. **MENU:** Press to access the following functions:



**Clock:** Press MENU until SELECT HOUR or SELECT MINUTE is displayed. Press ◀ SEL ▶ to decrease/ increase hours or minutes.

**Compression:** In CD mode, press to bring soft and loud passages together for a more consistent listening level. Press MENU until COMPRESS is displayed. Use SEL to toggle on/off.

**Dolby:** In tape mode, press MENU until DOLBY B XX appears in the display. Press SEL to toggle ON/OFF.

The Dolby® noise reduction system is manufactured under license from Dolby Laboratories Licensing Corporation. Dolby® and the double-D symbol are registered trademarks of Dolby Laboratories Licensing Corporation.

## Entertainment Systems

**Folder/Track Mode:** In MP3 mode, press MENU until MODE appears in the display. Use SEL to toggle between FOLDER (only tracks within selected folder are accessible) or TRACK (all tracks on disk are accessible) MODE.

**Autoset:** Press MENU until AUTOSSET appears in the display. Press SEL to toggle on/off. Allows you to set the strongest local stations without losing your original memory preset stations for AM/FM1/FM2. When the six strongest stations are filled, the station stored in preset 1 will begin playing. If there are less than six strong stations, the system will store the last one in the remaining presets.

8. **REPEAT:** Press to repeat the current CD/MP3 track. Press to show repeat status. Press again to toggle status.



9. **Balance:** Press BAL; then press SEL ◀ / ▶ to shift sound to the left/right speakers.

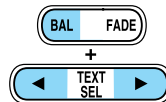

**Fade:** Press FADE; then press SEL ◀ / ▶ to shift sound to the rear/front speakers.

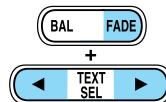

10. **SHUFFLE:** In CD/MP3 mode, press to play tracks in random order. Press to show shuffle status. Press again to toggle status.



11. **TEXT/SEL:** The filename, song title, artist text or album text may be viewed while playing an MP3 selection. Press TEXT to scroll through the text fields. The display will scroll through all of the text in the current field before changing to the next field. (TEXT must be pressed within three seconds of the previous button press to proceed to the next/last text display.) The last text field shown on the display will become the new display message default.



TEXT is also available when equipped with Satellite radio. Your radio comes equipped with Satellite ready capability. The kit to enable Satellite reception is available through your dealer. Detailed Satellite instructions are included with the dealer installed kit. *Dealer installed satellite kit only available in the continental United States.*

## Entertainment Systems

**Select:** Use with Bass, Treble, Balance, Fade and other menu selections.

12. **FOLDER▶** : Press to access the next MP3 directory folder.



13. **FOLDER◀** : Press to access the previous MP3 directory folder.



14. **Bass:** Press BASS; then press SEL ◀ / ▶ to decrease/increase the bass output.

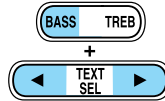

**Treble:** Press TREB; then press SEL ◀ / ▶ to decrease/increase the treble output.

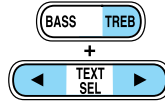

15. **Fast Forward (FF):** In CD mode, press and hold to fast forward. In tape mode, press to activate fast forward. Press FF again to return to play.



16. **Rewind (REW):** In CD mode, press and hold to reverse CD. In tape mode, press to rewind. Press REW again to return to play.



17. **Memory preset buttons:** To set a station: Press BAND to select the frequency band (AM/FM1/FM2) tune to a station, press and hold a preset button until sound returns.

18. **Scan:** Press to hear a brief sampling of all listenable stations, tape selections or CD tracks. Press again to stop.



19. **Tune/CAT:** TUNE: Works in radio mode only. Press TUNE ◀ / ▶ to change frequency down/up.



## Entertainment Systems

**CAT:** CAT is only available when equipped with Satellite Radio. Your radio comes equipped with Satellite ready capability. The kit to enable Satellite reception is available through your dealer. Detailed Satellite instructions are included with the dealer installed kit. *Dealer installed satellite kit only available in the continental United States.*

20. **Seek:** Press and release SEEK ◀ / ▶ for previous/next strong station, tape selection or CD track.



21. **BAND:** Press to toggle through AM/FM1/FM2 frequency bands.



22. **Cassette door:** Insert the cassette with the opening to the right.

23. **Power/volume:** Press to turn ON/OFF; turn to increase/decrease volume.

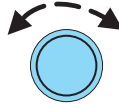



# Entertainment Systems

## Premium Satellite Compatible AM/FM Stereo In-Dash Six CD/MP3 Radio (if equipped)

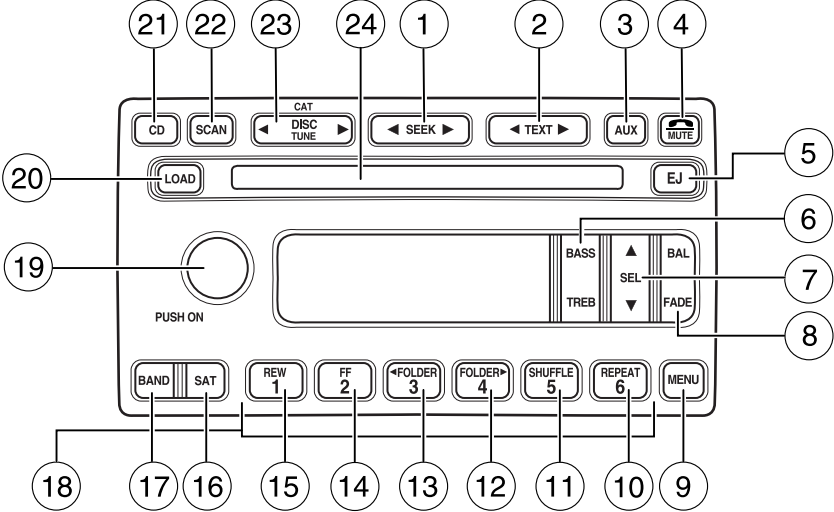

## Entertainment Systems

### Audiophile Satellite Compatible AM/FM Stereo In-Dash Six CD/MP3 Radio (if equipped)

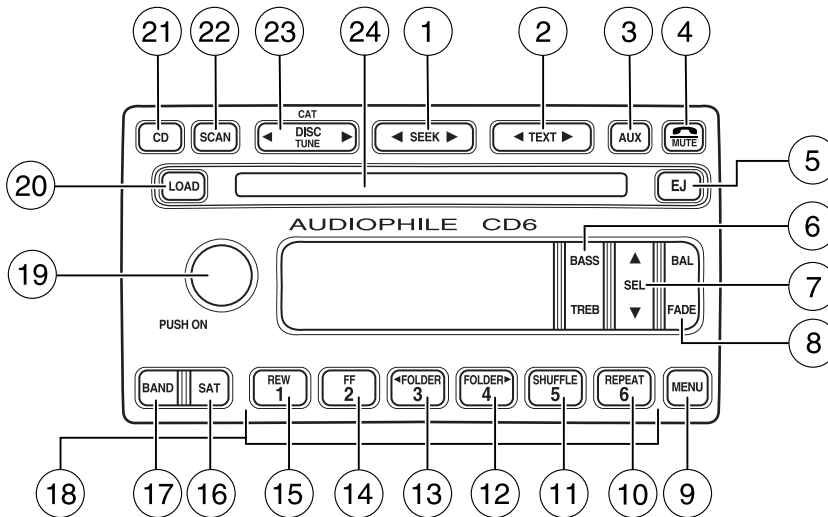

1. **SEEK:** Press and release  
SEEK ◀ / ▶ for previous/next  
strong station or track.



2. **TEXT:** The filename (Fi), song  
title (So), artist text (Ar) or album  
text (AL) may be viewed while  
playing an MP3 selection. When MP3 selection text is shown on the  
message display its corresponding text indicator (Fi, So, Ar, or AL) is  
shown in the elapsed time display. Press TEXT to scroll through the text  
fields. The display will scroll all of the text in the current field before  
changing to the next field. (TEXT must be pressed within 3 seconds of  
the previous button press to proceed to the next/last text display.)



TEXT is also available when equipped with Satellite radio. Your radio  
comes equipped with Satellite ready capability. The kit to enable Satellite  
reception is available through your dealer. Detailed Satellite instructions  
are included with the dealer installed kit. *Dealer installed satellite kit  
only available in the continental United States.*

26

2007 Escape Hybrid (ehv)  
Owners Guide (post-2002-fmt)  
USA (fus)

## Entertainment Systems

3. **AUX:** This function is not operational.



4. **MUTE:** Press to MUTE playing media; press again to return to playing media



5. **EJ:** Press to eject a CD. Press EJ and a memory preset to eject a specific disc. Press and hold to eject all loaded discs.



6. **Bass:** Press BASS; then press SEL ▼ / ▲ to decrease/increase the bass output.

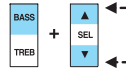

**Treble:** Press TREB; then press SEL ▼ / ▲ to decrease/increase the treble output.

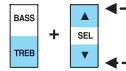

7. **Select:** Use with Bass, Treble, Balance, Fade and other menu functions.



8. **Balance:** Press BAL; then press SEL ▼ / ▲ to shift sound to the left/right speakers.

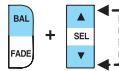

**Fade:** Press FADE; then press SEL ▼ / ▲ to shift sound to the rear/front speakers.

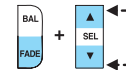

9. **Menu:** Press to access the following features:

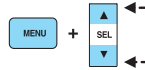

**RDS (if equipped):** Press and hold MENU to access RDS on/off. Use SEL to toggle RDS on/off. Press MENU again to access Traffic mode, Program Type mode or Show Type mode. (MENU must be pressed within 10 seconds to proceed to the next RDS mode).

The Federal Communications Commission (FCC) and the Canadian Radio and Telecommunications Commission (CRTC) recommend that FM radio broadcasters use RDS technology to transmit information. FM radio

## Entertainment Systems

stations are independently operated and individually elect to use RDS technology to transmit station ID and program type as desired.

**Traffic:** Allows you to hear traffic broadcasts. With the feature ON, press SEEK or SCAN to find a station broadcasting a traffic report (if it is broadcasting RDS data). *Traffic information is not available in most U.S. markets.*

**FIND Program type:** Allows you to search RDS-equipped stations for a certain category of music format: Classic, Country, Info, Jazz, Oldies, R&B, Religious, Rock, Soft, Top 40. Press and hold MENU until RDS XX is shown in the display. Press MENU until FIND appears in the display. Use SEL to scroll through music types. Press SEEK or SCAN to search for a station playing the requested music category.

**Show TYPE:** Displays the station's call letters or music format. Press and hold MENU until RDS XX is shown in the display. Press MENU until SHOW appears in the display. Use SEL to select NAME or TYPE.

**Occupancy mode:** Press MENU until occupancy mode appears in the display. Press SEL to select ALL SEATS, DRIVER SEAT or REAR SEATS occupancy mode.

**Compression:** Brings soft and loud CD passages together for a more consistent listening level when in CD mode. Press MENU until compression status is displayed. Press the SEL control to enable the compression feature when COMPRESS OFF is displayed. Press the SEL control again to disable the feature when COMPRESS ON is displayed.

**Autoset:** Allows you to set the strongest local radio stations without losing your original manually set preset stations for AM/FM1/FM2. Press MENU until AUTOSET appears in the display. Press SEL to toggle ON/OFF. When the six strongest stations are filled, the station stored in preset 1 will begin playing. If there are less than six strong stations, the system will store the last one in the remaining presets.

**Setting the clock:** Press MENU until SELECT HOUR or SELECT MINS is displayed. Use SEL to manually increase (▲) or decrease (▼) the hours/minutes. Press MENU again to disengage clock mode.

**Folder/Track Mode:** In MP3 mode, press MENU until MODE appears in the display. Use SEL to toggle between FOLDER (only tracks within selected folder are accessible) or TRACK (all tracks on disc are accessible) MODE.

## Entertainment Systems

10. **REPEAT:** Repeats current CD/MP3 track when active (ON). Press to show repeat status. Press again to toggle status.



11. **SHUFFLE:** Plays CD/MP3 tracks in random order when active (ON). Press to show shuffle status. Press again to toggle status.



12. **FOLDER ▶:** Press to access the next MP3 directory.



13. **FOLDER ◀:** Press to access the previous MP3 directory.



14. **FF**(Fast forward): In CD mode, press until desired selection is reached.



15. **REW**(Rewind): In CD mode, press until desired selection is reached.



16. **SAT (if equipped):** Your radio comes equipped with Satellite Ready capability. The kit to enable the Satellite reception is available through your dealer. Detailed satellite instructions are included with the dealer installed kit. *Dealer installed satellite kit only available in the continental United States.*



17. **BAND:** Press to toggle between AM/FM1/FM2 frequency band.



18. **Memory presets:** To set a station: Select frequency band, tune to a station, press and hold a preset button until sound returns.



19. **Power/volume:** Press to turn ON/OFF; turn to increase or decrease volume levels.

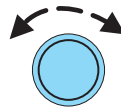

## Entertainment Systems

20. **Load:** Press to load a CD. Press LOAD and a memory preset to load to a specific disc slot. Press and hold to load up to six discs.



21. **CD:** Press to enter CD mode.



**CD units are designed to play commercially pressed 4.75 in (12 cm) audio compact discs only. Due to technical incompatibility, certain recordable and re-recordable compact discs may not function correctly when used in Ford CD players. Irregular shaped CDs, CDs with a scratch protection film attached, and CDs with homemade paper (adhesive) labels should not be inserted into the CD player. The label may peel and cause the CD to become jammed. It is recommended that homemade CDs be identified with permanent felt tip marker rather than adhesive labels. Ballpoint pens may damage CDs. Please contact your authorized dealer for further information.**

22. **Scan:** Press SCAN to hear a brief sampling of radio stations or CD/MP3 tracks. Press again to stop.



23. **Disc/Tune:** Press ◀ or ▶ to



manually tune down/up the radio frequency band, or to listen to the previous/next CD.

**CAT:** CAT is only available when equipped with Satellite Radio. Your radio comes equipped with Satellite ready capability. The kit to enable Satellite reception is available through your dealer. Detailed Satellite instructions are included with the dealer installed kit. *Dealer installed satellite kit only available in the continental United States.*

For information regarding SIRIUS Satellite Radio, please call toll-free 888-539-SIRIUS (888-539-7474) or visit the SIRIUS website at [www.siriusradio.com](http://www.siriusradio.com)

24. **CD slot:** Insert a CD, label side up.

## Entertainment Systems

### AM/FM stereo in-dash six CD modular audio (if equipped)

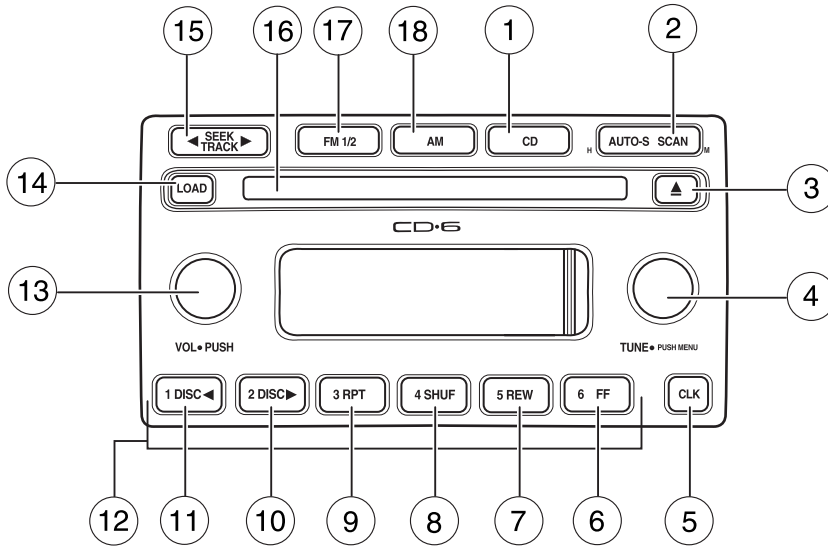

1. **CD:** To begin CD play, press  LOAD. When the system is ready to accept a disc, IN will appear on the radio display. You may then insert a CD. The system will load the CD and begin play after a short pause. The disc number and track number will illuminate in the display. If a CD is already loaded into the system, press CD to enter CD mode and select the desired CD to play.

**CD units are designed to play commercially pressed 4.75 in (12 cm) audio compact discs only. Due to technical incompatibility, certain recordable and re-recordable compact discs may not function correctly when used in Ford CD players. Irregular shaped CDs, CDs with a scratch protection film attached, and CDs with homemade paper (adhesive) labels should not be inserted into the CD player. The label may peel and cause the CD to become jammed. It is recommended that homemade CDs be identified with permanent felt tip marker rather than adhesive labels. Ballpoint pens may damage CDs. Please contact your dealer for further information.**

## Entertainment Systems

2. **AUTO — SCAN:** AUTO: Auto memory tuning allows you to set strong radio stations without losing your original manually set preset stations.

Press the AM or FMI/2 control to select a frequency. Press and momentarily hold the AUTO-S control. The system will beep. When the first six strong stations are filled, the strongest station will start playing. Press AUTO-S to select from the stored stations. One stored station will be selected and played each time the control is pressed. The frequency and the channel number will be displayed.



**SCAN:** Scan works in radio and CD mode. Press SCAN to hear a brief sampling of all listenable stations on the frequency band or the first ten seconds of each track. Press SCAN again to stop.

3. **Eject:** Press to eject the CD currently playing. Press CD plus the preset number to eject a specific CD. Press and hold to eject all CDs.



4. **TUNE — MENU:** Press to enter Menu mode. Press repeatedly to scroll through the following options:

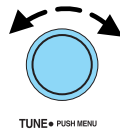

**Bass:** Press the control until BASS appears in the display. Turn the control to increase/decrease the level of bass.

**Mid-range (if equipped):** Press the control until MID appears in the display. Turn the control to increase/decrease the level of mid-range.

**Treble:** Press the control until TREB appears in the display. Turn the control to increase/decrease the level of treble.

**Fade:** Press the control until FADE appears in the display. Turn the control to adjust the sound between the rear and front speakers.

**Balance:** Press the control until BAL appears in the display. Turn the control to adjust the sound between the left and right speakers.

5. **CLK (Clock):** Press to alternate between clock display and audio display.



**Note:** If the audio operation is selected while the clock mode is on, the selected audio mode will be displayed for ten seconds, then the display will revert to the clock mode.

**Setting the clock:** Press and hold CLK for approximately two seconds until a beep is heard. The clock's current time will flash. Press SCAN on



## Entertainment Systems

the minute set control (M) to set the minutes. Press AUTO-S on the hour set control (H) to adjust the hours. Press CLK again to disengage clock mode.

6. **FF (Fast forward):** In CD mode, press and hold to advance through a track at high speed.



7. **REW (Rewind):** In CD mode, press and hold to reverse through a track at high speed.



8. **SHUF (Shuffle):** Press to play all tracks on the current CD in random order.



9. **RPT (Repeat):** Press to repeat the current CD track. The track will repeat continuously until RPT is pressed again.



10. **DISC**  : Press to skip forward to the beginning of the next CD.



11. **DISC**  : Press to skip back to the beginning of the previous CD.



12. **Memory presets:** To set a station: Select frequency band AM/FM; tune to a station, press and hold a preset button until sound returns.

13. **Volume/ON/OFF:** Press to turn ON/OFF. Turn to increase/decrease the level of volume.

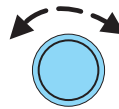

14. **LOAD:** The load feature allows you to load up to six single CDs into the audio system. Press LOAD. "In" will appear in the display when the system is ready. Insert the CD.



**Autoload:** To load up to six CDs into the system: Press and hold LOAD until a beep is heard. When "In" is displayed, insert the desired CD. When "In" is displayed again, insert the next CD. Continue until all six are loaded (if desired).

## Entertainment Systems

15. **SEEK — TRACK:** In radio mode, press to find the next (▶) or previous (◀) listenable station on the frequency band.



In CD mode, press to listen the next (▶) or previous (◀) track.

16. **CD door:** Insert CDs label side up.



17. **FM 1/2:** Press to enter FM mode. Press to toggle between FM1 and FM2.



18. **AM:** Press to enter AM mode.



### GENERAL AUDIO INFORMATION

**Radio frequencies:** AM and FM frequencies are established by the Federal Communications Commission (FCC) and the Canadian Radio and Telecommunications Commission (CRTC). Those frequencies are:

AM - 530, 540–1700, 1710 kHz

FM- 87.7, 87.9–107.7, 107.9 MHz

**Radio reception factors:** There are three factors that can affect radio reception:

- Distance/strength: The further you travel from a station, the weaker the signal and the weaker the reception.
- Terrain: Hills, mountains, tall buildings, power lines, electric fences, traffic lights and thunderstorms can interfere with your reception.
- Station overload: When you pass a broadcast tower, a stronger signal may overtake a weaker one and play while the weak station frequency is displayed.

### Cassette/player care:

Do:

- Use only cassettes that are 90 minutes long or less.
- Tighten very loose tapes by inserting a finger or pencil into the hole and turning the hub.
- Remove loose labels before inserting tapes.
- Allow tapes which have been subjected to extreme heat, humidity or cold to reach a moderate temperature before playing.

34

*2007 Escape Hybrid (ehv)  
Owners Guide (post-2002-fmt)  
USA (fus)*

## Entertainment Systems

- Clean the cassette player head with a cassette cleaning cartridge after 10–12 hours of play to maintain good sound/operation.

Don't:

- Expose tapes to direct sunlight, extreme humidity, heat or cold.
- Leave tapes in the cassette player for a long time when not being played.

### **CD/CD player care:**

Do:

- Handle discs by their edges only. Never touch the playing surface.
- Inspect discs before playing. Clean only with an approved CD cleaner and wipe from the center out.

Don't:

- Expose discs to direct sunlight or heat sources for extended periods of time.
- Clean using a circular motion.

**CD units are designed to play commercially pressed 4.75 in (12 cm) audio compact discs only. Due to technical incompatibility, certain recordable and re-recordable compact discs may not function correctly when used in Ford CD players. Dirty, warped or damaged CDs, irregular shaped CDs, CDs with a scratch protection film attached, and CDs with homemade paper (adhesive) labels should not be inserted into the CD player. The label may peel and cause the CD to become jammed. It is recommended that homemade CDs be identified with permanent felt tip marker rather than adhesive labels. Ballpoint pens may damage CDs. Please contact your authorized dealer for further information.**

**Audio system warranty and service:** Refer to the *Warranty Guide* for audio system warranty information. If service is necessary, see your dealer or qualified technician.

### **Accessory delay**

With accessory delay, the window switches, moon roof (if equipped) and audio system may be used for up to ten minutes after the ignition switch is turned off or until either front door is opened.

## Entertainment Systems

### VEHICLE NAVIGATION RADIO (VNR IF EQUIPPED)

Your vehicle may be equipped with a Vehicle Navigation Radio (VNR) which allows you to listen to the radio, play CDs and also navigate the vehicle using navigation CDs.



Your Vehicle Navigation Radio is equipped with many different features and controls. The labeled controls on the front face of the system are known as hard keys. The five blank controls located under the MENU control are called soft keys. (Refer to *System Overview*.) These controls are labeled on the screen and can change functionality depending on which screen is activated in the display. The hard keys will be explained further below and the soft keys will be described as needed.

### Safety information



Please read and follow all stated safety precautions. Failure to do so may increase your risk of collision and personal injury.

### **Ford Motor Company shall not be liable for any damages of any type arising from failure to follow these guidelines.**

Do not attempt to service, repair or modify the system. See your Ford or Lincoln Mercury dealer.



The driver must not attempt to operate any detailed operation of the navigation system while the vehicle is in motion. Give full attention to driving and to the road. Pull off the road and park in a safe place before performing detailed operations.

## Entertainment Systems

A safety screen will be displayed each time the navigation system is turned on as a reminder. Ensure that you are familiar with the system's features and functionality, including the following:

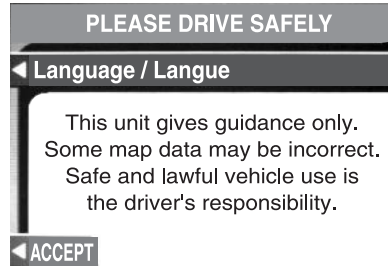

- Do not turn the ignition key or start the engine while the software is updating.
- Do not apply pressure to the display screen.
- The navigation system is not a substitute for your personal judgement.
- Route suggestions should not supersede local traffic regulations or safe driving practices.
- Do not follow route suggestions if they direct you to perform an unsafe or illegal maneuver, would place you in an unsafe situation, or would route you into an area that you consider unsafe.
- Drivers should not rely on screen displays while their vehicle is in motion. Let the voice guide you. If viewing is necessary, pull off the road to a safe location.
- Do not use the navigation system to locate emergency services.
- For road safety reasons, the driver should program the system only when the vehicle is stationary. Certain functions will therefore not operate while the vehicle is in motion.
- The navigation CD does not reflect road detours, closures or construction, road characteristics such as rough road surface, slope or grade, weight or height restrictions, traffic congestion, weather or similar conditions.
- To use the system as effectively and safely as possible, obtain up-to-date navigation CD's whenever they become available.
- Set the volume level so that you can hear directions clearly.
- Do not disassemble or modify the system as this may lead to damage and void your warranty. If a problem occurs, stop using the system immediately and contact your Ford or Lincoln Mercury dealer.

## Entertainment Systems

### System overview

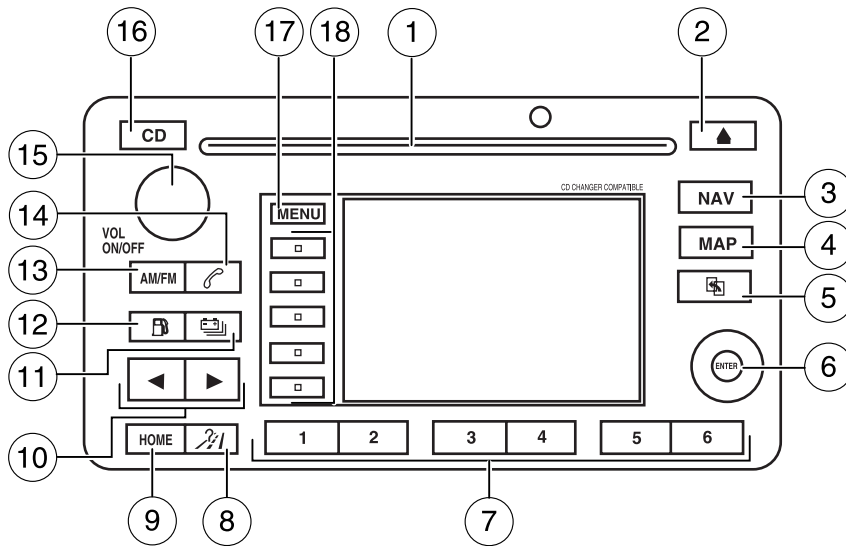

1. **CD slot:** Insert an audio CD, label side up.
2. **Eject:** Press this control to eject an audio CD or a navigation CD.

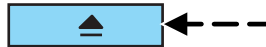

3. **Navigation (NAV):** Press the NAV control to access the navigation system menu.
4. **MAP:** The MAP control works in all modes. Press to show current location.
5. **BACK:** This control works only in Navigation mode. Press to return to the previous screen.



## Entertainment Systems

6. **ENTER:** Use this control when viewing a menu in the navigation system. Press the control up or down, left or right to highlight an item in the display. Press the center of the control to make your selection.

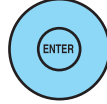

7. **Memory presets:** The memory presets store favorite AM/FM stations and allow you to access various discs when in CD DJ mode. Press and hold a preset control until PRESET SAVED appears in the display.



8. **Current location:** Press for information on your current location.



9. **HOME:** When the home location is empty, pressing and holding this key will store the vehicle's current location as home. Pressing the home key after the home location has been set will calculate a route to that set home location.



10. **SEEK:** Use these controls to find the previous/next (◀/▶) listenable radio station or advancing tracks in CD mode.



11. **Energy flow function:** Press for status of the engine and battery. Refer to *Energy Flow Screen* later in this chapter for further information.



12. **Fuel economy function:** Push to advance to the fuel economy screen. The screen will show the average fuel economy. Refer to *Fuel economy function* later in this chapter for further information.



13. **AM/FM:** Press to listen to the AM or FM frequency band (AM, FM1, FM2). Pressing AM/FM in Navigation mode will return you to the audio screen.



## Entertainment Systems

Turn the control to adjust the audio volume levels. To adjust the voice output levels from the navigation system, adjust the volume levels only during voice output.

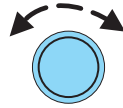

14. **Phone (if equipped):** If the phone button is pressed and a phone is not present, this will mute the playing media.



15. **On/volume:** Press to turn the system on, turn to adjust the volume. Press again to turn the system off.

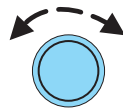

16. **CD:** Press to enter CD mode or to begin play of a CD that is already loaded in the system. Press the CD control again to toggle CD, CD DJ and DVD (if equipped).



**Note:** Navigation CD's are not operational in the CD DJ.

**Note:** To use the navigation system and listen to an audio CD, the navigation CD must be loaded into the VNR and the audio CD must be loaded into the CD DJ.

17. **MENU:** The MENU control works in both the audio and navigation mode. Press to access various menus in both modes.



18. **Soft keys:** Press the correct soft key to make selections with the navigation system.





## Entertainment Systems

### Quick start – how to get going

#### To play a radio station:

1. Ensure that the ignition and the Vehicle Navigation Radio (VNR) system are ON.
2. Press the AM/FM control to select the desired frequency band.



3. Press the SEEK control to locate a station.



#### To play a CD in the VNR:

1. Ensure that the ignition and the VNR system are ON.
2. Insert a CD into the single slot of the VNR and the CD will automatically begin play. If a CD is already loaded into the system, press the CD control.



#### To play a CD in the CD DJ:

1. Ensure that the ignition and the VNR system are ON.
2. Insert CD(s) into the CD DJ magazine. Insert magazine into CD DJ. If the CD DJ magazine is already loaded, press the CD control to toggle through CD and CD DJ.



3. Press the memory presets to choose the desired disc in the CD DJ.



4. Press the seek control to advance to different tracks.



**Note:** Navigation CD's are not operational in the CD DJ.

#### To use the Navigation system:

1. Ensure that the ignition and the VNR system are ON, and a map data disc is inserted into the VNR CD slot.

**Note:** To use the navigation system and listen to an audio CD, the navigation CD must be loaded into the VNR and the audio CD must be loaded into the CD DJ.

## Entertainment Systems

2. Press the NAV control to enter into Navigation mode.

NAV

3. To enter a destination, ensure that the vehicle is in the PARK position.

4. To navigate to home from the current location, press HOME. If a home location has not previously been stored, pressing and holding HOME will store the vehicle's current location as home.

HOME

### Energy Flow Screen

Your Vehicle Navigation System is equipped with an Energy Flow Screen. This screen provides a graphical representation of how power is transferred in the Hybrid system to either accelerate the vehicle, or re-charge the battery. The screen also provides you with titles to describe the mode which is currently active in the Hybrid system. These screens are informational and do not require any input from you. Note that due to the one second screen updates and the simplification of the graphics, the display may not show the actual vehicle status.

To view the Energy Flow Screen, press the battery icon. While the display is activated, the audio will continue to play.



1. **Engine Power:** This line represents how much power is being provided to the wheels by the engine. The arrow will always flow in one direction and point to the wheels.

2. **Engine:** This icon represents the Internal Combustion Engine (ICE). It will be highlighted in orange only when the ICE is running.

3. **Generator Power:** This line represents how much power is being generated by the engine for use by the HV electric system, or how much power is being used by the HV electric system to control/start the engine.

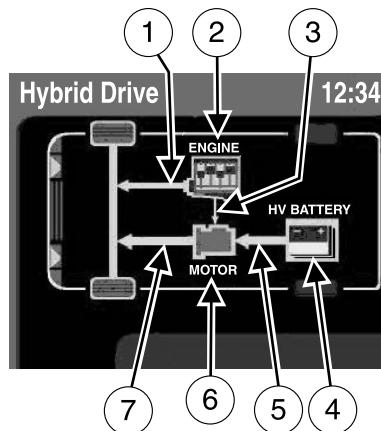

## Entertainment Systems

4. **HV Battery:** This icon represents your High Voltage Battery. The fill level (shown in green), represents the state of charge of the HV Battery and will go up and down as the battery charges/discharges during normal operation.

5. **Battery Power:** This line represents how much power the HV battery is providing to accelerate the vehicle (discharging), or how much power is being delivered back through the motor to the battery (charging).

6. **Electric Motor:** This icon represents the Hybrid Electric Motor. This symbol will be highlighted in orange after the vehicle has been started and will remain highlighted until key off to indicate that the vehicle is ready to be driven.

7. **Motor Power:** This line represents how much power the electric motor is delivering to the wheels (acceleration), or how much power is being delivered back through the motor to charge the battery (deceleration/braking.)

**Note:** The power arrows may point in different directions, indicating which way the power is flowing. The arrows may also vary in width to indicate the different levels of power being provided to that component.

The energy flow screens contain a title to indicate what mode the Hybrid system is in.

The vehicle is being powered by both the electric motor and the engine.

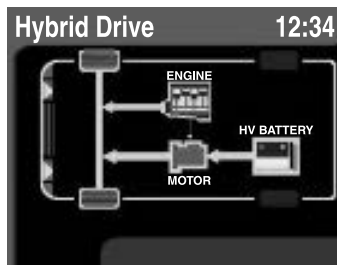

## Entertainment Systems

The vehicle is slowing down and power is being stored in the high voltage (HV) battery by the Hybrid system.

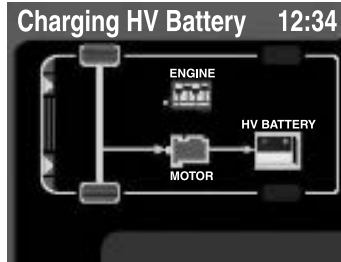

The vehicle is in a state similar to idle, except that power is being generated to recharge the high voltage battery.

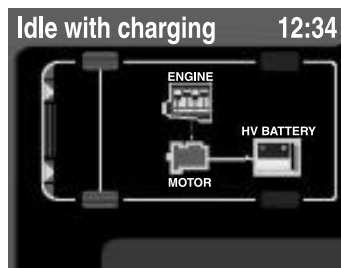

The vehicle is being powered by the engine, not the electric motors. This occurs at higher speeds.

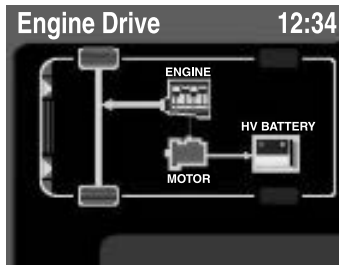

## Entertainment Systems

The vehicle is either at rest, or is sharing very little power between the Hybrid parts. This can occur at higher speeds if the vehicle is not speeding up or slowing down.

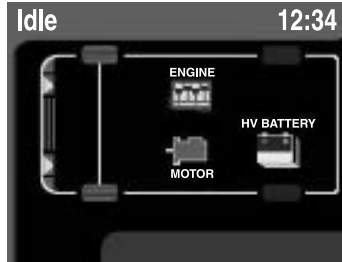

The vehicle is driving in electric mode. (Power is coming from the electric motors and not the engine).

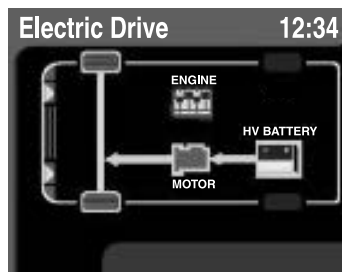

### Fuel economy screen

Your Vehicle Navigation Radio is equipped with a fuel economy screen. To view, press the fuel icon control. This screen displays three pieces of information:



- **Instantaneous Fuel Economy (IFE):** The IFE is displayed on the vertical bar on the left of the screen ranging from 0 mpg up to MAX, which indicates excellent fuel economy. Your vehicle must be moving to calculate instantaneous fuel economy.

When the vehicle is not moving, the IFE function will display no bar on the IFE graph indicating 0 mpg. Conversely, if you are driving in electric mode (Engine off), this function will display MAX. IFE cannot be reset.

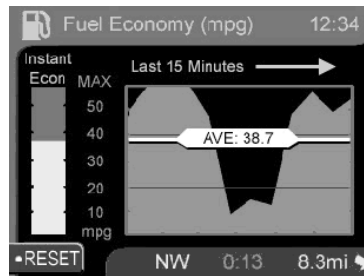

## Entertainment Systems

- **Average Fuel Economy (AFE):** The AFE is displayed on the white bar across the graph. The AFE will be retained when the key is turned OFF, and will continue averaging when driving resumes. Pressing RESET will reset the AFE to zero.
- **One minute average graph:** The graph is updated each minute with the fuel economy that was achieved during the prior minute of driving. Each new one minute average will be added to the left side of the graph, shifting the past data to the right. When the graph area is full, the right most point will be deleted, keeping a running scroll from left to right of the last 15 minutes of driving. The graph is intended to provide a graphical representation of how driving habits/conditions can affect fuel economy. Note that the graph will be cleared anytime the key is turned out of RUN (however, the average fuel economy bar will retain its value). Press RESET to clear the graph.

If the Navigation System has been set to units of Kilometer, the Fuel Economy Screen will display the equivalent Consumption Graph in units of L/100KM. In Consumption (L/100KM) mode, the IFE function will display MAX until the vehicle is moving. For more information on Average Fuel Economy, refer to *Message center* in the *Driver Controls* chapter.

### Audio features

Your Vehicle Navigation Radio has many features including a full range of audio functions.

#### Audio screen display

When in audio mode, there are various indicators which will appear on the display.

1. Station name
2. Station frequency
3. Stereo indicator
4. Preset selected
5. Band selected
6. Music type (when instructed by the system).

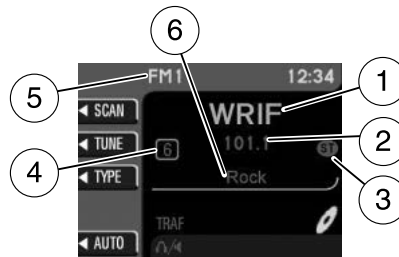

If the navigation system is activated during radio or CD playback (CD DJ), audio output continues but route guidance screens will appear in the display.

## Entertainment Systems

### **Volume/power control**

Press the control to turn the audio/navigation system on or off.

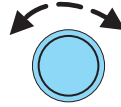

Turn the control to raise or lower volume. The levels will be displayed on the screen.

**To adjust the navigation voice output level, adjust the volume control only when the navigation system is speaking. Otherwise, it will adjust the radio levels.**

### **Automatic volume control (AVC)**

With this feature, radio volume changes automatically with vehicle speed to compensate for road and wind noise. To engage the AVC feature:

1. Press the MENU control.

**MENU**

2. Select AUDIO OPTIONS.



3. Select AVC, TRAFFIC, DSP.

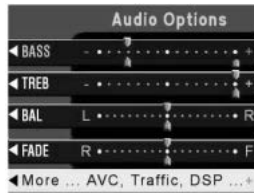

## Entertainment Systems

4. Select AVC.

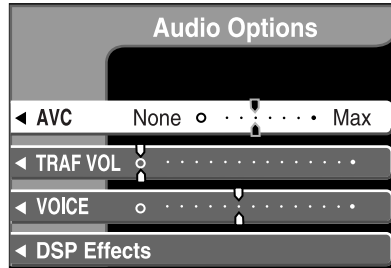

5. Use the cursor control to increase or decrease the levels. The higher the level selected, the greater the compensation. The levels will be shown in the display. Decrease all the way to the left to turn AVC off.

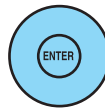

### **AM/FM select**

The AM/FM control works in radio, CD and navigation modes.



### **AM/FM select in radio mode**

This control allows you to select AM or FM frequency bands. Press the control to switch between AM, FM1 or FM2 memory preset stations.

### **AM/FM select in CD mode**

Press to stop CD play and begin radio play.

### **Radio reception factors:**

- **Distance/strength.** The further an FM signal travels, the weaker it is. The listenable range of the average FM station is approximately 40 km (24 miles). This range can be affected by "signal modulation." Signal modulation is a process radio stations use to increase their strength/volume relative to other stations.
- **Terrain.** Hills, mountains and tall buildings between your vehicle's antenna and the radio station signal can cause FM reception problems. Static can be caused on AM stations by power lines, electric fences, traffic lights and thunderstorms. Moving away from an interfering structure (out of its "shadow") returns your reception to normal.

48

2007 Escape Hybrid (ehv)  
Owners Guide (post-2002-fmt)  
USA (fus)



## Entertainment Systems

- **Station overload.** Weak signals are sometimes captured by stronger signals when you pass a broadcast tower. A stronger signal may temporarily overtake a weaker signal and play while the weak station frequency is displayed.

### **AM/FM select in navigation mode**

Press once when in navigation mode to return to the audio screen (while the navigation function continues to work in the background). Press again to enter AM/FM mode where you are able to make frequency band adjustments.

### **CD select**

To begin CD play (if a CD is already loaded), press the CD control. The first track of the disc will begin playing. After that, CD play will begin where it stopped last. Press the CD control again to toggle between CD and CD DJ modes.



If a navigation CD is in the head unit and you press CD, the system will automatically search for an audio CD in the CD DJ and begin play if it is present.

### **Adjusting the levels**

1. Press the MENU control.



2. Select the AUDIO OPTIONS soft key.



## Entertainment Systems

3. Select BASS, TREB (Treble), BAL (Balance) or FADE.

The bass adjust allows you to increase or decrease the audio system's bass output.

The treble adjust control allows you to raise or lower the audio system's treble output.

The balance feature allows sound distribution to be adjusted between the right and left speakers.

Speaker sound can be adjusted between the front and rear speakers using the fade feature.

4. Use the cursor control to increase or lower the bass and treble levels or to adjust the sound between the front and rear or between the left and right speakers.

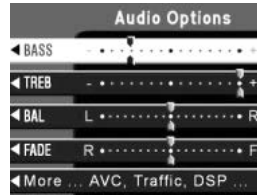
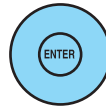

### **DSP (Digital Signal Processing) (if equipped)**

The Digital Signal Processing (DSP) feature allows you to change the signal mode to suit your listening tastes.

Press the soft key to turn the feature on or off.

This feature can be accessed by selecting the menu option "More. . . AVC, Traffic, DSP. . ." within the "Audio Options" menu.

You can then select the following signal modes:

- NEWS — "voice-only" type of sound with a limited audio band
- JAZZ CLUB — jazz club with clearly reflected sounds
- HALL — rectangular concert hall capacity of about 2,000
- CHURCH — church with a high vault
- STADIUM — outdoor stadium with a capacity of about 30,000



This system has three "occupancy modes" of listening:

- DRIVER— Optimizes audio playback for the drivers seat position.
- ALL — Optimizes audio playback to be similar for ALL seating positions.

50

**2007 Escape Hybrid (ehv)  
Owners Guide (post-2002-fmt)  
USA (fus)**

## Entertainment Systems

- REAR — Optimizes the audio playback for rear seat passengers.

### **Rewind/fast forward**

Press the ►► and ◀◀ controls to fast forward or rewind a CD track.



### **Seek function**

The SEEK control works in all modes.



### **Seek in radio mode**

- Press ◀ to find the next listenable station down the frequency band.
- Press ► to find the next listenable station up the frequency band.

### **Seek in CD or CD DJ mode**

- Press ◀ to seek to the previous track of the current disc. If a selection has been playing for three seconds or more and you press ◀, the CD changer will replay that selection from the beginning.
- Press ► to seek forward to the next track of the current disc. After the last track has been completed, the first track of the current disc will automatically replay.

### **Seek in navigation mode**

- Press ◀ or ► to access the next audio station if in radio mode, and next track if in CD mode.

### **Radio station memory preset**

The radio is equipped with six station memory preset controls. These controls can be used to select up to six preset AM stations and twelve FM stations (six in FM1 and six in FM2).

The presets will also allow you to access CDs which are loaded in the CD DJ. When in CD mode, simply press the preset number which corresponds to the desired disc.

## Entertainment Systems

### Setting memory preset stations

1. Select the frequency band with the AM/FM select control.
2. Select a station. Refer to *Tune adjust* or *Seek function* for more information on selecting a station.
3. Press and hold a memory preset control until PRESET SAVED appears on the display.



### Autoset memory preset

Autoset allows you to set strong radio stations without losing your original manually set preset stations. This feature is helpful on trips when you travel between cities with different radio stations.

### Starting autoset memory preset

1. Select a frequency band using the AM/FM select controls.
2. Press the AUTO control.
3. When the first six strong stations are filled, the station stored in memory preset control 1 will start playing.



If there are less than six strong stations available on the frequency band, the remaining memory preset controls will all store the last strong station available.

Any preset stored via the presets directly (pressing and holding) in this mode are temporary.

A message will indicate whenever a temporary preset is stored or recalled. This mode is active while the AUTO soft key is highlighted.

To deactivate autoset and return to your audio system's manually set memory stations, press the AUTO control again.

## Entertainment Systems

### **Tune adjust**

The tune feature works in radio mode.

- Select the TUNE soft key.
- Press SEEK to go up ► or down ◀ the frequency band manually.



### **Stereo indicator**

Whenever a stereo signal is received in radio mode, the stereo indicator (ST) will appear in the display.

### **Scan function**

Press the soft key next to SCAN for a brief sampling of all listenable stations on the selected frequency. Press again to disable scan and remain on the current station.



### **Program type (PTY) selections**

Some FM stations transmit program type codes which can be used to locate different stations transmitting programs of a certain type.

Press the soft key next to TYPE to access a list of available program types.



Use the cursor control to select the desired program type. The system will search for and begin playing that program type if available. During a seek or scan and for 10 seconds after a station is found, pressing the seek up/down or scan will initiate another search. If the desired type cannot be found, "Not Found" appears in the display and the audio system returns to the original station.

### **Traffic information**

The Traffic information soft key can be accessed under menu option "MORE . . . AVC, Traffic, DSP..." within the "AUDIO OPTIONS" menu.

## Entertainment Systems

Select the TRAF soft key to select traffic information broadcast from certain stations which will automatically interrupt radio or CD playback at a preset volume level. The default Traffic volume can be adjusted with the slider bar using the cursor input. Moving the position to the left most position will turn this feature off.

The display TRAF will appear in Orange if the feature is enabled, but there is no broadcast traffic program available.

**Traffic information is not available in most U.S. markets.**

### Compression

The compression feature will boost quieter music and lower louder music to minimize the need for volume adjustments.

When in CD or CD DJ mode, press COMP to engage or disengage the compression feature.



### Shuffle

When in CD or CD DJ mode, press SHUF to engage and disengage the shuffle feature. All tracks on the current disc will be played in random order.

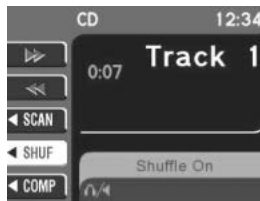

### CD DJ (if equipped)

Your vehicle may be equipped with a CD DJ (CD changer) located under the passenger seat.

Radio power must be turned on to play the CDs in the CD DJ. The magazine may be stored in the glove box when not being used.

The CD magazine may be inserted or ejected with the radio power off.

ONLY use the magazine supplied with the CD DJ, other types will damage the unit.

Keep the CD DJ door closed. Coins and foreign objects will damage the CD player and void your audio system warranty.

The CD magazine does not have to be full (all 6 disks) for the CD DJ to function.

## Entertainment Systems

CD units are designed to play commercially pressed 4.75 in (12 cm) audio compact discs only. Due to technical incompatibility, certain recordable and re-recordable compact discs may not function correctly when used in Ford CD players. Irregular shaped CDs, CDs with a scratch protection film attached, and CDs with homemade paper (adhesive) labels should not be inserted into the CD player. The label may peel and cause the CD to become jammed. It is recommended that homemade CDs be identified with permanent felt tip marker rather than adhesive labels. Ballpoint pens may damage CDs. Please contact your authorized dealer for further information.

### To access the CD DJ:

Slide the door to access the CD DJ magazine.

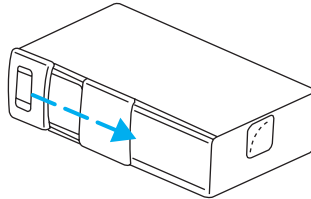

Press ▲ to eject the magazine.

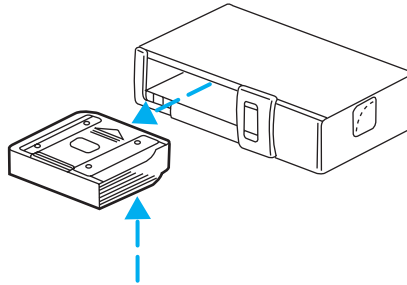

1. Pull the lever to remove a CD tray from the magazine.

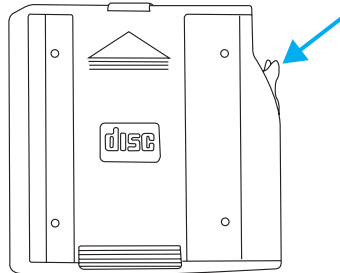

## Entertainment Systems

2. Insert one disc into each CD tray of the magazine (up to 6 discs). Ensure that the label side is facing up.

If you pull too hard on the disc holder, the disc holder may come completely out of the magazine. If this happens, reinsert the disc holder back into the magazine.

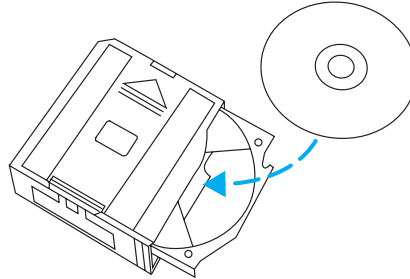

3. Insert each CD tray, with the disc loaded, all the way into the CD magazine.

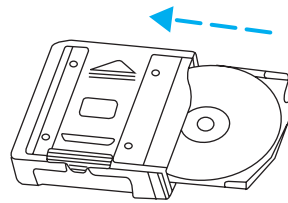

4. Insert the CD magazine into the CD DJ.

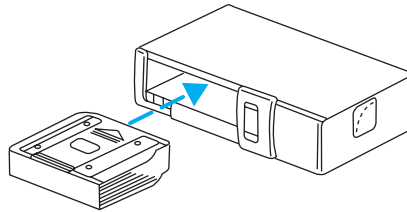

5. Slide the door to the left to close.

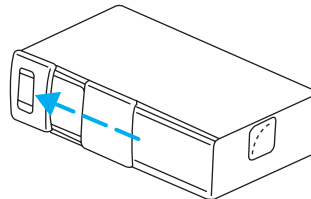

Use only compact discs containing this mark.



The magazine does not need to be full for the CD DJ to operate.



## Entertainment Systems

Radio power must be turned on to play the CDs in the CD DJ. The magazine may be stored in the glove compartment when not being used. The CD magazine may be inserted or ejected with the radio power off.

Ensure that the disc holder is evenly inserted and at the same level as the magazine (A). The unit will not operate if the disc holder is not inserted at the same level (B).

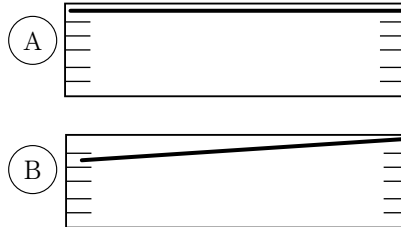

### **CD DJ information screen**

The CD DJ screen will display various information such as:

- Track selected
- Elapsed time
- Selected disc
- Volume level
- On-screen selections



### **CD DJ playback**

With a navigation CD inserted into the audio unit, press CD for CD DJ playback. Without a navigation CD inserted into the audio unit, press CD until CD DJ appears in the display.



If playback is selected and the CD DJ is empty or the magazine is missing or incorrectly inserted, NO DISC (S) will appear in the display. If the selected CD is missing, NO DISC is displayed and the unit selects the next available disc. The audio unit remembers which discs are available, so it will not select a disc that it knows is missing. Instead, NO DISC appears in the display and the current disc remains selected. If the selected CD is damaged or upside down, CHECK DISCS and the disc number are displayed. The unit then selects the next available disc. During normal operations, CDs and tracks are played sequentially in ascending order. Playback continues at track one if the end of a disc is reached and with CD DJ playback, disc one will follow disc six.

## Entertainment Systems

### **Rewind/fast forward feature**

When in CD DJ mode, press and hold the **▶▶** or **◀◀** control to search forward or in reverse on the current disc.



### **Scan feature**

When in CD DJ mode, press SCAN for a brief sampling of all tracks on the current CD. Press again to disengage the feature and listen to the selected song.



### **Shuffle mode**

When in CD DJ mode, press SHUF to engage and disengage the shuffle feature. The tracks will be played in random order. The unit will play all the tracks on the selected disc and then move onto the other discs and play the tracks in random order.

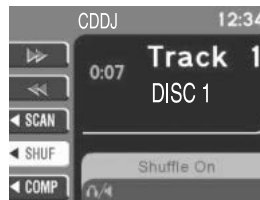

### **Compression**

The compression feature will boost quieter music and lower louder music to minimize the need for volume adjustments.

When in CD DJ mode, press COMP to engage or disengage the compression feature.

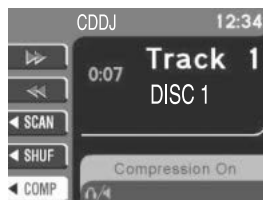

## Entertainment Systems

### Navigation features

The route guidance navigation system in your audio unit will not function unless a navigation CD is inserted.

**Ensure that you follow highway code restrictions and do not take any risks. For example, if you are unable to make a U-turn, continue on your journey. The navigation system will recalculate your route to get you back to an appropriate road to your destination.**



For road safety reasons, information should only be entered when the vehicle is stationary.

### Please drive safely

This screen may appear on your VNR display. Press the soft key next to the display to select the desired language. Press the control next to ACCEPT to confirm your selection.

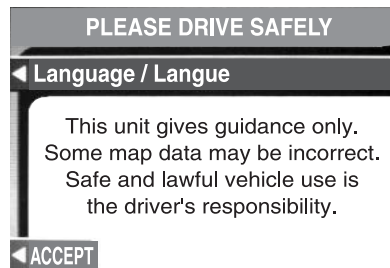

### Navigation screen display

When in navigation mode, there will be various indicators on the screen to help you in operating your system.

1. Direction to destination
2. Distance to final destination
3. Estimated time to destination
4. Current directional heading and GPS signal strength (color)
5. Vehicle icon (current vehicle position)
6. ZOOM
7. PAN
8. DETOUR
9. VOICE

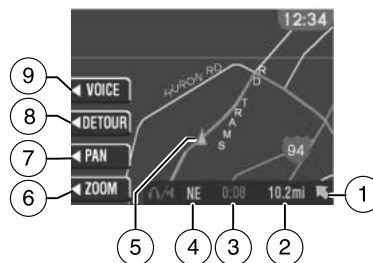

## Entertainment Systems

### ***Principles of GPS (Global Positioning System) operation***

Your Vehicle Navigation System directs you based on information derived from satellites, road maps stored on the CD, sensors in your vehicle and the desired destination. The system compiles all necessary information to guide you to your selected destination. Space satellites determine the vehicle's current location and transmit position and time signals to your car.

If the vehicle has been parked for a long period of time, the navigation function may be temporarily unresponsive. The navigation system will operate reliably again once GPS reception is available in a few minutes.

### ***Limited GPS reception***

System performance may be adversely affected if GPS reception is interrupted or interference occurs over a distance of several miles. The following are possible causes for GPS reception being interrupted. If the vehicle is:

- in multi-story parking garages
- in tunnels and under bridges
- in between high buildings
- by forests or tree-lined avenues
- in heavy rain showers and thunderstorms
- in valleys and in mountainous regions

The GPS signal strength may vary. The directional heading indicator at the bottom of the screen might change color to indicate this signal strength. The colors are as follows:

- Green — A clear GPS signal is being received.
- Yellow — The GPS signal is partially blocked.
- Red — The GPS signal is unavailable and may be temporarily blocked.

**Note:** After an ignition cycle, the system must connect to a satellite signal to get the time for the display.

## Entertainment Systems

### To enter navigation mode

Press NAV to access the navigation system menu.



Use the cursor control, or the corresponding soft key to confirm your selection.

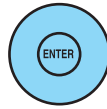

If you select the wrong item, press the BACK control to return to the previous screen. Or, press NAV to return to the main Destination Entry menu and start again.

### Map display information

When using the navigation system, the map display screen will appear to guide you to your location. On the screen, you are able to make the following choices:



- **VOICE** — Press to repeat the last voice prompt.
- **DETOUR** — Press to select a detour from your current navigation route.
- **PAN** — Press to move the current view of the map.
- **ZOOM** — Press to adjust the area covered on the map display. The map zoom levels are:  $\frac{1}{8}$ ,  $\frac{1}{2}$ , 1, 4, and 16 miles.

### Selecting a destination

Press NAV to access the destination entry menu.



From this menu, you may select from the following options:

- **Address/Intersection** – Use to select a destination based on a known street address or intersection. **Not available when the vehicle is moving.**
- **Point of Interest** – Use to select a destination that is a point of interest location (i.e., airport, restaurant, hospital). **Not available when the vehicle is moving.**

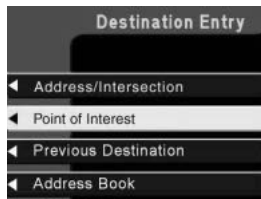

## Entertainment Systems

- **Previous Destination** – Use to select a destination from the last 50 destinations entered.
- **Address Book** – Use to select a destination from previously stored entries.

### **Address/Intersection**

Use the soft keys to select Address/Intersection from the Destination Entry menu. The next two options available are:

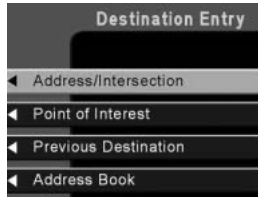

- **Town/City Name** – Select this option if you know the town or city name.
- **Street Name** – Select if you know the street address but are uncertain of the city.

The next two options are:

- **Address range** – Select the numerical address of the destination.
- **Intersection** – Select the intersection closest to the destination.

**Note:** The intersection function is not available when the vehicle is moving.

### **Points of Interest (POI)**

This destination option enables you to specify a particular place, such as an airport or gas station. Use the soft keys to select 'Point of Interest'. In the next menu, you will have the following options:

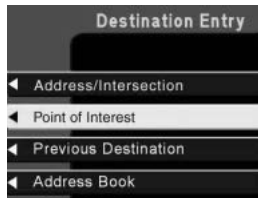

- **By Category** – Lists POIs by categories, such as airports, gas stations, etc. Use the cursor control to select and confirm choice.
- **By Name** – A keyboard display enables you to spell out the first four letters of the desired POI. A slight time delay will occur if large numbers of letter options are available.

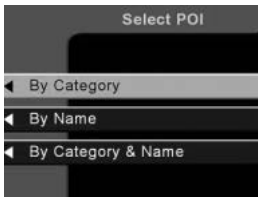

## Entertainment Systems

- **By Category & Name** – Lists categories, then allows you to spell out the first four letters of your destination.

After making these selections, three further options are displayed:

- **Show All** – Lists entries in alphabetical order.
- **Sort by Distance** – Lists the closest POI entries to the vehicle's current location.
- **Within a Town/City** – Lists entries for a specific city in alphabetical order.

**Note:** The intersection function is not available when the vehicle is moving.

Certain categories may not be available in some areas and POIs may not all be listed. Up to date information also depends upon using the latest navigation CD available.

### **Previous destination**

The last 50 destinations entered into the navigation system are automatically stored in the system's memory.

Use the soft key to select Previous Destination. The address of each stored destination will appear.

The previous origin information is also stored in this location. This stores the location where the vehicle last started off from and is updated each time the vehicle completes a journey.

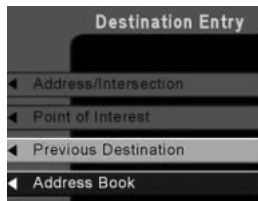

### **Deleting a previous destination**

- Use the cursor control to select the destination to be deleted.
- Press DELETE.

A confirmation screen will appear before the deletion is complete.

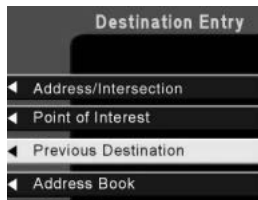

## Entertainment Systems

### Entering a destination using the keyboard of lists

After selecting the desired choice from the Destination Entry menu, there are two main ways to enter your destination in the VNR system:

**Keyboard** – the keyboard display enables you to spell out a town, city, street or point of interest.

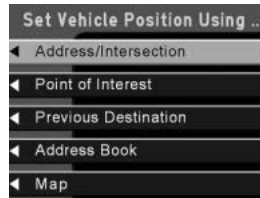

- Use the cursor control to highlight the desired character(s).
- Push in the control to confirm the selection. A highlight bar will automatically begin searching the current files for the listing.
- To move back to previously selected characters, press DELETE.

**List** – Your VNR system shows a list of town/cities, streets or points of interest and a highlight bar indicates the line selected. You may choose any of these for a destination.

- Press LIST to enter list mode.
- Use the cursor control to scroll through the selections.
- Press in the cursor control to confirm the selection.

### Selecting Route Criteria

Once you have selected a destination, select from the following route criteria:

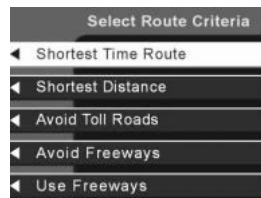

1. **Shortest time route** — Creates a driving route which minimizes driving time taking into consideration things such as speed limits, number of turns, etc.
2. **Shortest distance** — Creates a driving route the shortest distance from the current location.
3. **Avoid toll roads** — Creates a driving route which avoids toll roads where possible.
4. **Avoid freeways** — Creates a driving route which avoids major freeways where possible.

64

2007 Escape Hybrid (ehv)  
Owners Guide (post-2002-fmt)  
USA (fus)



## Entertainment Systems

5. **Use freeways** — Creates a route which uses freeways where possible.

### **Route calculation**

Once the route criteria is selected, the navigation system automatically calculates a route to the selected destination. The route appears on the display screen and a voice prompt provides instructions.

This screen will appear for a few seconds while the navigation system is calculating your route.

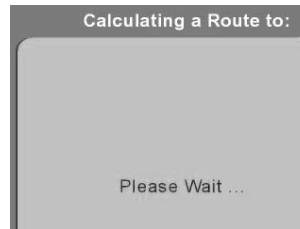

### **Please proceed**

Once the route is calculated, “Please Proceed” is displayed with a map on the display. Also included in the display:

- the planned route is shown in pink
- parts of the planned route containing incomplete map data are highlighted in “cautionary” yellow
- major roadways are shown in blue
- other streets are shown in white
- your vehicle location is shown as a pink/yellow triangle
- the arrow at the foot of the screen points to your destination



You are able to choose from three viewing options in this display:

- **PLAN** — Press this soft key to scroll through your entire route. This option is only available prior to beginning the journey.
- **PAN** — Press this soft key, then use the cursor control to pan up, down, left or right on the map. This option is only available when the vehicle is not in motion.
- **ZOOM** — Press this soft key multiple times (or use the cursor input) to select the desired zoom level on the map. The zoom level is shown at the bottom of the screen.

## Entertainment Systems

### Guide display

Once your vehicle is moving along the highlighted route, the Guide display screen will automatically appear. This screen shows your next turn as voice prompts direct you on the route. When the planned route contains incomplete map data, the guide display maneuvers are identified in “cautionary” yellow. The screens and voice prompts are continually updated to correspond with your vehicle location. To disengage the voice prompts, refer to *Navigation options* in this section. If you are turning onto a road with incomplete map data, the turn icon will be highlighted in a “cautionary” yellow. If the next maneuver is desired, press the cursor control down.

The voice volume level may be adjusted by turning the volume control during a voice prompt only.

On the Guide display screen, there are two display functions which are available if needed:

- VOICE — Press to repeat the current voice prompt.
- DETOUR — Press to select a detour. For more information on detours, refer to *Detours, interruptions and route changes* in this chapter.
- CANCEL — Press to cancel the guide display.

While in the Guide display screen, the cursor input can be used to preview future/up coming maneuvers. This can be done by pressing down on the cursor input to go to the next maneuver instruction, and pressing up to go to the previous maneuver. Pressing the NAV control at any time will set you back to the current maneuver/turn instruction.

### True view

As you approach an intersection, the Guide display screen will automatically change to a close-up view (True view) of the junction. The close-up view will automatically return to the Guide display screen once a turn has been completed.



When the planned route contains incomplete map data, the close-up view maneuvers are identified in “cautionary” yellow.

## Entertainment Systems

### **Arrival**

When you approach your destination, the destination indicator will appear on the map display screen as a circular icon. When you arrive, the name and address of your destination will be displayed.

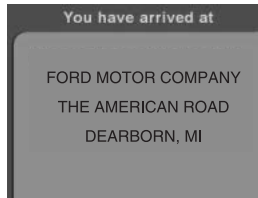

### **Navigation screen display**

The address book feature allows you to store up to 50 alphabetical destinations. To store an address:

1. Once in navigation mode, select "Address Book".
2. Press ENTER to confirm the selection.

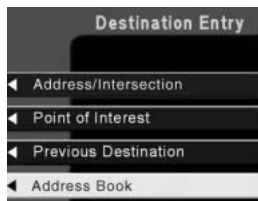

Stored addresses will appear in the display. If no entries exist, an empty address book screen is shown.

Use the cursor control to select the desired entry.

### **Adding, deleting or editing the address book**

**Note:** These features are not available when the vehicle is in motion.

1. Ensure that you are in navigation mode.
2. Select Address book.
3. Confirm selection by pressing ENTER.
4. Press the DELETE soft key to delete the current entry.
5. Press the ADD soft key to add an additional entry.

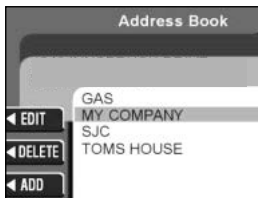

## Entertainment Systems

6. Press the EDIT soft key to edit the current entry.

- Use the cursor control to select a letter.
- Push the control to add a letter to the name. If you make a mistake, you can press the DELETE soft key.
- Press the DONE soft key to save your entry under the name you spelled.



### **Storing the current car position in the address book**

If you are at a location you would like to store in the address book, such as a new restaurant:

- Select ADDRESS BOOK from the Destination Entry menu.
- Press the ADD soft key.
- Press the CURRENT LOCATION soft key.
- Assign a name to the entry as described in *Adding, deleting or editing the address book* above.
- Press the DONE soft key to save your entry under the name you chose.

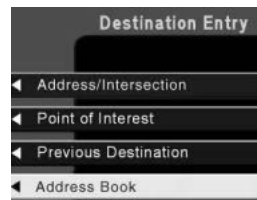

### **Current location**

To access your current location, press this when in navigation mode. Your current location and the name/distance to the next/last intersection are displayed.



Press NAV to return to a guidance display. Press MAP to return to a map display.

## Entertainment Systems

### **Detours, route interruptions and changes**

If need be, your navigation system can easily and quickly find the most efficient detour around road construction, unexpected traffic or undesirable roads.

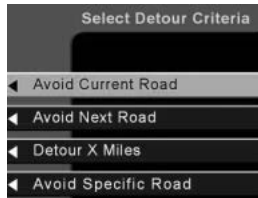

### **Detour options**

You may engage the detour option when in the Guide display, True view or Map display screens.

Press the control next to DETOUR to activate.

Use the soft keys to select and enter your new route criteria. Press the key to confirm selection. The following options are available:

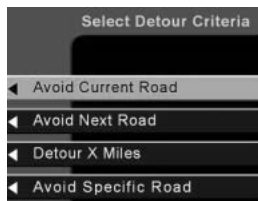

- **AVOID CURRENT ROAD** — Updates your route to avoid the road which you are on currently.
- **AVOID NEXT ROAD** — Updates your route to avoid the next road planned on your journey.
- **DETOUR (X) MILES** — Provides a detour from the current route for the noted distance. Use the cursor control to indicate the distance which needs to be avoided. The range available is based on the length of your original route.
- **AVOID SPECIFIC ROAD** — Avoids a specific road on your planned route.

### **Route interruptions**

In the course of your destination, you may decide to temporarily leave your planned route for gas, food, etc. If you turn off the ignition, the option to continue the route guidance will be displayed when the ignition is turned on again. Use the cursor control to select from one of the following options:

## Entertainment Systems

- Resume route - The navigation system displays the Select Route Criteria screen. Refer to *Selecting Route Criteria* earlier in this chapter.
- Cancel route - Press to return to the main menu.



If the ignition is not turned off, simply continue along your highlighted route.

### **Route changes or cancellations**

To cancel or change your current route:

- Press BACK, then select “Cancel Guidance” or
- Press the CANCEL soft key.

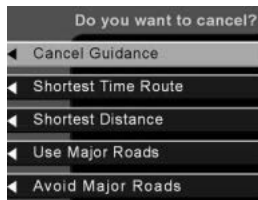

### **Navigation Menu**

You are able to make various adjustments in navigation mode. To view the options, press the control next to “Option Menu” to select from the following options:



### **Navigation options**

Once in the navigation preference menu, you may select from the following options:

- VOICE — Select to turn the voice output on or off and to adjust the volume level.
- MAP — Choose between “Heading up” to put your direction of travel toward the top of the screen, or “North up” to ensure that North is always at the top of the screen.



## Entertainment Systems

- UNITS — Press to select from miles or kilometers. When kilometers are selected, it will affect the map and the fuel economy screen.

### Display options

Use this feature to change the display setting. This feature can be accessed by selecting “Display Options” within the Main Menu.

Use the cursor control to select one of the following options:

- MODE — auto (automatic), day or night display settings.
- BRIGHTNESS— provides manual adjustment for screen brightness.
- Turn Display Off— Turns the display off. Press any button to turn the display back on again.



### System options

- Language Selection: Use the cursor control to select and enter the desired voice and text language.

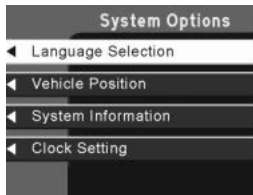

- Clock Setting: Your vehicle is equipped with a clock in the VNR system. To set the clock:

1. Access the CLOCK screen.

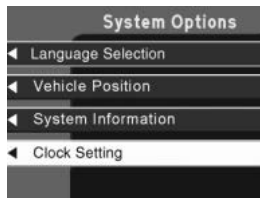

## Entertainment Systems

2. Press the TIME control to select the hours or minutes to set.
3. Use the cursor control to increase or decrease the hours or minutes.
4. Press DONE to set the time.
5. Select the SET soft key to synchronize/set the minutes and seconds to GPS time. The hours will remain at the user set value.



You may choose to set the clock to a 12 or 24 hour display.

### General information

#### **Federal Communication Commission (FCC) Compliance**

Changes or modifications not approved by Ford or Lincoln Mercury could void user's authority to operate the equipment. This equipment has been tested and found to comply with the limits for a Class B digital device, pursuant to Part 15 of the FCC Rules. These limits are designed to provide reasonable protection against harmful interference in a residential installation. This equipment generates, uses and can radiate radio frequency energy and, if not installed and used in accordance with the instructions, may cause harmful interference to radio communications.

However, there is no guarantee that interference will not occur in a particular installation. If this equipment does cause harmful interference to radio or television reception, which can be determined by turning the equipment off and on, the user is encouraged to consult the dealer or an experienced radio/TV technician for help.

#### **Cleaning the display**

Do not spray cleaning fluid directly onto the unit. Instead, spray onto a soft cloth and gently wipe the unit. Only recommended products should be used.

Do not clean any part of the system with benzene, paint thinner or any other solvent.

Do not spill liquids of any kind onto the unit.

The navigation system utilizes a database stored in a special format on a CD. It is recommended always to use the latest update of this map CD.

- The navigation system will only work with CDs specifically intended for your navigation system.



## Entertainment Systems

- Always store the map CDs in their protective cases when not in use.

### **Map coverage**

Please refer to the *In-dash Navigation System Quick Start* for individual map CD content details.

CDs contain map data for all of the continental United States and parts of Canada. In some less populated areas, even though a map is displayed, map data may be incomplete (does not contain one-way street information, turn restrictions, speed limits, etc.) In these cases, the system will alert the driver and route guidance directions on the display are highlighted in “cautionary” yellow.

### **Ordering additional map CDs**

If you wish to order additional maps, or report possible problems with your current map CD, please call **NAVTEQ at 1-(888) NAV-MAPS**, (1-888-628-6277) toll-free or write

NAVTEQ

P.O. Box 543442

Chicago, IL 60654-0442

Website — [www.navteq.com](http://www.navteq.com)

### **Latest map CDs**

The traffic network is constantly changing due to new roads, traffic restrictions, etc. Therefore, it is not always possible to exactly match the digital CD map with the current roadways. To help with accuracy, always use the latest version of the map CD for navigation.

## Climate Controls

### MANUAL HEATING AND AIR CONDITIONING SYSTEM

1. **Fan speed adjustment:** Controls the volume of air circulated in the vehicle.

2. **Air flow selections:** Controls the direction of the airflow in the vehicle. See the following for a brief description on each control.

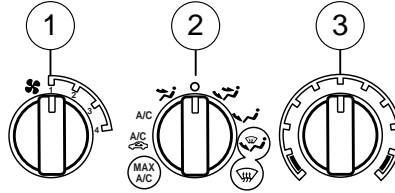

**MAX A/C:** Uses recirculated air to cool the vehicle. Air flows from the instrument panel vents only. **Note:** With the climate system set to MAX A/C mode, the engine will typically run continuously, reducing fuel economy. This also applies to the other two modes displayed with an orange graphic: (defrost/floor), and (defrost).

**A/C** : Uses recirculated air to cool the vehicle. Air flows from the instrument panel vents only. **Note:** When A/C mode is selected, you may notice the air temperature cycle from cooler to warmer as the engine turns on and off.

**A/C:** Uses outside air to cool the vehicle. Air flows from the instrument panel vents only. **Note:** When A/C mode is selected, you may notice the air temperature cycle from cooler to warmer as the engine turns on and off.

: Distributes outside air through the instrument panel vents.

**O (OFF):** Outside air is shut out and the fan will not operate.

: Distributes outside air through the instrument panel vents and the floor vents.

: Distributes outside air through the floor vents.

: Distributes outside air through the windshield defroster vents and floor vents. The air conditioner will automatically turn on to dehumidify the air.

**Note:** With the climate system set to (defrost/floor) mode, the engine will typically run continuously, reducing fuel economy.



: Distributes outside air through the windshield defroster vents. The air conditioner will automatically turn on to dehumidify the air.

**Note:** With the climate system set to (defrost) mode, the engine will typically run continuously, reducing fuel economy.

3. **Temperature selection:** Controls the temperature of the airflow in the vehicle.

## Climate Controls

### Operating tips

- To reduce fog build up on the windshield during humid weather, place the air flow selector in the  position.
- To reduce humidity build up inside the vehicle in cold weather: do not drive with the air flow selector in the O (OFF), A/C  or MAX A/C position.
- Under normal weather conditions, do not leave the air flow selector in MAX A/C, A/C  or O (OFF) when the vehicle is parked. This allows the vehicle to “breathe” using the outside air inlet vents.
- Do not put objects under the front seats that will interfere with the airflow to the back seats.
- Remove any snow, ice or leaves from the air intake area at the base of the windshield.

To aid in side window defogging/demisting in cold weather:

1. Select A/C.
2. Adjust the temperature control to maintain comfort.
3. Set the fan speed to 4.
4. Direct the outer instrument panel vents towards the side windows.

To increase airflow to the outer instrument panel vents, close the vents located in the middle of the instrument panel.



Do not place objects on top of the instrument panel as these objects may become projectiles in a collision or sudden stop.

### REAR WINDOW DEFROSTER

The rear defroster control is located on the instrument panel. Press to clear the rear window of thin ice and fog. The small LED will illuminate when activated.



Ensure that the ignition is in the 3 (RUN) position in order to operate the rear window defroster.

The defroster turns off automatically after 15 minutes or when the ignition is turned to the 1 (LOCK) position. To manually turn off the defroster before 15 minutes have passed, push the control a second time.

## Lights

### HEADLAMP CONTROL ☀️

Rotate the headlamp control to the first position 🚗 to turn on the parking lamps. Rotate to the second position 🚗 to also turn on the headlamps.

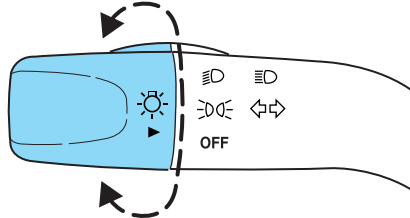

### Headlamp battery saver

The battery saver will shut off the exterior lamps 10 minutes after the ignition switch has been turned off if the headlamp control is in the 🚗 position. The system will not shut off the parking lamps if the headlamp control is in the 🚗 position.

### Autolamp control (if equipped)

The autolamp system sets the headlamps to turn on and off automatically. The autolamp control, located on the headlamp switch, will:

- turn on the lamps automatically at night
- turn off the lamps automatically during the daylight
- keep the lamps on for up to three minutes after the key is turned to OFF.

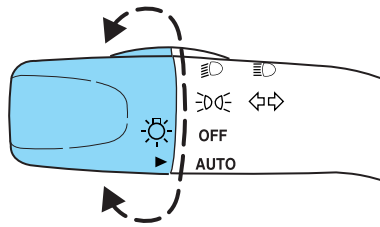

See *Autolamp delay system (if equipped)* to set the auto headlamp off delay time.

### Autolamp delay system (if equipped)

If your vehicle has an autolamp delay feature, you can set the delay time to keep the headlights on for up to three minutes after the key is turned OFF. The delay time is set to 20 seconds at the factory, but the delay time may be changed by following the steps below (Steps 1 through 6 must be done within 10 seconds):

## Lights

1. Turn the key to the 1 (LOCK) position.
2. Rotate the headlamp control to the autolamp position.
3. Rotate the headlamp control to the OFF position.
4. Turn the key to the 3 (RUN) position.

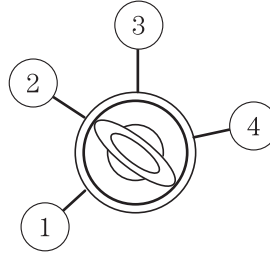

5. Turn the key back to the 1 (LOCK) position.
6. Turn the headlamp control to the autolamp position (the headlights should turn on).
7. Turn the headlamp control to the OFF position when the desired delay time (up to 3 minutes) has been reached.

### High beams

Push the lever toward the instrument panel to activate. Pull the lever towards you to deactivate.

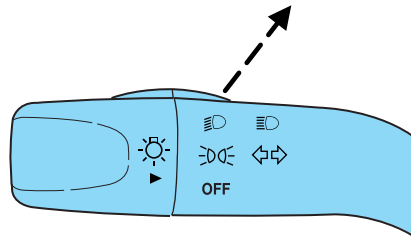

### Flash to pass

Pull toward you slightly to activate and release to deactivate.

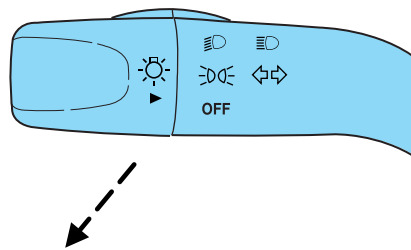

## Lights

### Daytime running lamps (DRL) (if equipped)

Turns the lowbeam headlamps on with a reduced output.

To activate:

- the ignition must be in the 3 (RUN) position.
- the headlamp control must be in the OFF, parking lamps or autolamp position.
- the parking brake must be released.



Always remember to turn on your headlamps at dusk or during inclement weather. The Daytime Running Lamp (DRL) system does not activate the tail lamps and generally may not provide adequate lighting during these conditions. Failure to activate your headlamps under these conditions may result in a collision.

### Smart park lamps (if equipped)

If your vehicle is equipped with the DRL and autolamp features, your park lamps will turn on automatically when lighting conditions are dark and DRLs are activated (the headlamp control is in the OFF position).

### Foglamp control (if equipped)

Press the foglamp control, located on the instrument panel, to activate the foglamps. The foglamp indicator will illuminate when the foglamps are on. Press the foglamp control to deactivate the foglamps.

The foglamps will only operate with the parking lamps or headlamps on. When the highbeams are activated, the foglamps will not operate.

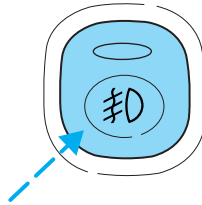

## Lights

### PANEL DIMMER CONTROL

Use to adjust the brightness of the instrument panel.

- Push and hold top of control to brighten.

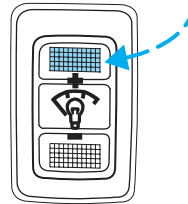

- Push and hold bottom of control to dim.

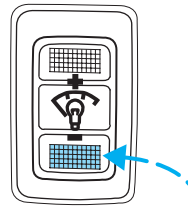

### AIMING THE HEADLAMPS

The headlamps on your vehicle are properly aimed at the assembly plant. If your vehicle has been in an accident the alignment of your headlamps should be checked by your authorized dealer.

#### Vertical aim adjustment

1. Park the vehicle directly in front of a wall or screen on a level surface, approximately 25 feet (7.6 meters) away.

- (1) 8 feet (2.4 meters)
- (2) Center height of lamp to ground
- (3) 25 feet (7.6 meters)
- (4) Horizontal reference line

2. Measure the height from the center of your headlamp to the ground and mark an 8 foot (2.4 meter) horizontal reference line on the vertical wall or screen at this height (a piece of masking tape works well). The center of the lamp is marked by a 3.0 mm circle on the headlamp lens.

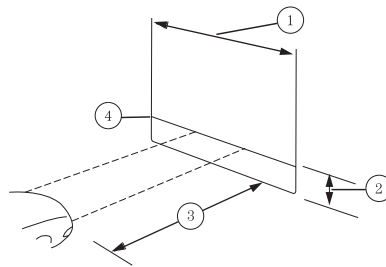

## Lights

3. Turn on the low beam headlamps to illuminate the wall or screen and open the hood. Cover the left-hand headlamp with an opaque cloth.

4. On the wall or screen you will observe a light pattern with a distinct horizontal edge of high intensity light towards the right. If this edge is not at the horizontal reference line, the beam will need to be adjusted.

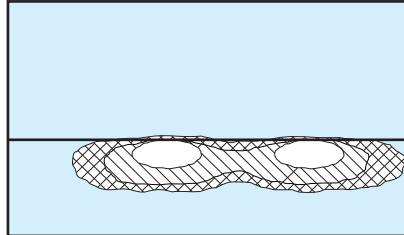

5. Locate the vertical adjuster on the headlamp, then use a 4 mm socket to turn the adjuster either counterclockwise (to adjust down) or clockwise (to adjust up) aligning the upper edge of the light pattern to the horizontal line.

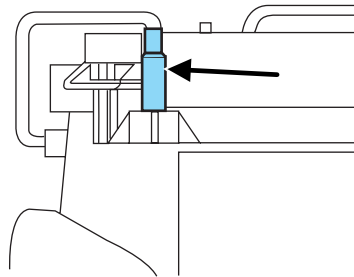

6. Move the opaque cloth to cover the right-hand headlamp and repeat Steps 4 and 5 for the left-hand headlamp.

7. HORIZONTAL AIM IS NOT REQUIRED FOR THIS VEHICLE AND IS NON-ADJUSTABLE.

8. Close the hood and turn off the lamps.

### TURN SIGNAL CONTROL ⇄

- Push down to activate the left turn signal.
- Push up to activate the right turn signal.

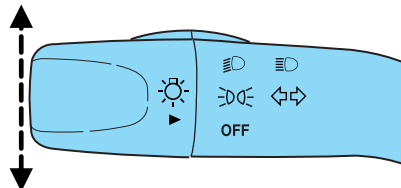

## INTERIOR LAMPS

### Dome lamps and map lamps

The front dome lamp is located overhead between the driver and passenger seats.



## Lights

The dome lamp control has three positions:

- OFF: In this position, the lamp will not illuminate.
- DOOR: In this position, the dome lamp will illuminate only when a door is opened and will remain illuminated for 25 seconds after the door is shut.
- ON: In this position, the lamp will remain illuminated.

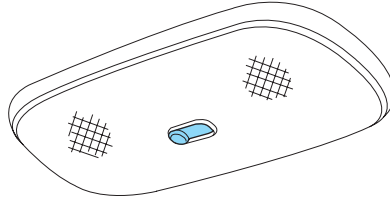

The map lamp controls (without moon roof) are located on the dome lamp. Press the button on either side of each map lamp to illuminate the lamps. Push the button again to turn off the lamps.

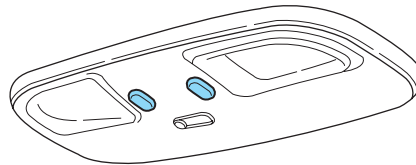

For models equipped with a moon roof, the map lamps are located on the moon roof control panel. Press the button on either side of each map lamp to illuminate the lamps. Push the button again to turn off the lamps.

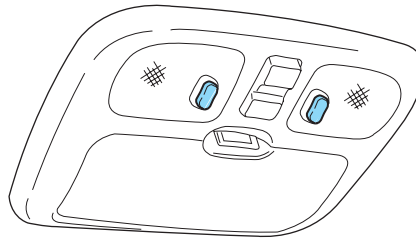

The map lamps will illuminate whenever a door is opened. After the door is shut, the lamps will remain illuminated for 25 seconds.

### Cargo and dome lamp

Rear cargo lamp equipped with an ON/OFF/DOOR control will light when:

- the doors are closed and the control is in the ON position.
- the control is in the DOOR position and any door is open.

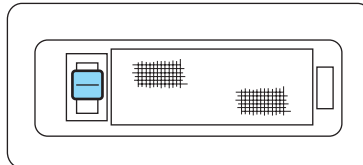

When the control is in the OFF position, it will not illuminate when you open the doors.

## Lights

### BULB REPLACEMENT

#### Headlamp Condensation

The headlamps are vented to equalize pressure. When moist air enters the headlamp(s) through the vents, there is a possibility that condensation can occur. This condensation is normal and will clear within 45 minutes of headlamp operation.

#### Using the right bulbs

Replacement bulbs are specified in the chart below. Headlamp bulbs must be marked with an authorized "D.O.T." for North America and an "E" for Europe to ensure lamp performance, light brightness and pattern and safe visibility. The correct bulbs will not damage the lamp assembly or void the lamp assembly warranty and will provide quality bulb burn time.

Function	Number of bulbs	Trade number
Park/turn lamps (front)	2	3157 AK (amber)
Headlamps (low beams)	2	H11
Headlamps (high beams)	2	H7
Rear stop/tail/sidemarkers	2	3157K or 4157K
Rear turn lamps	2	3156
Backup lamp	2	3156
Foglamp (front)	2	PS24WFF
Center High-mount stop lamp	5	W5W
Rear license plate lamp	2	W5W
All replacement bulbs are clear in color except where noted.		
To replace all instrument panel lights - see your authorized dealer		

#### Replacing the interior bulbs

Check the operation of all bulbs frequently.

#### Replacing exterior bulbs

Check the operation of all the bulbs frequently.

#### Replacing headlamp bulbs

1. Make sure that the headlamp control is in the OFF position and open the hood.

## Lights

2. Press down on the wire retainer to release it and access the back of the headlamp assembly.

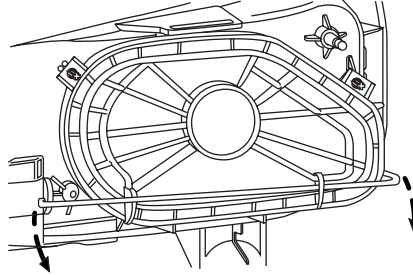

### *Lowbeam bulb replacement*

3. Locate the outboard most bulb, turn it a ¼ turn to the outside of the vehicle and pull the bulb socket straight out to remove the bulb.

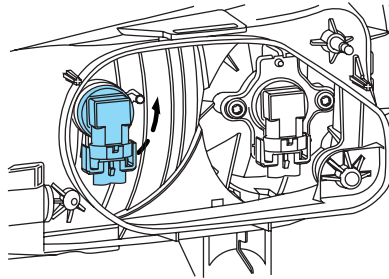

### *Highbeam bulb replacement*

4. Locate the bulb that is the most center in the vehicle, rotate the socket counterclockwise and pull the bulb socket straight out to remove the bulb.

5. Pull the bulb straight out of the socket and push in the new bulb.

6. To complete installation, follow the removal procedure in reverse order.

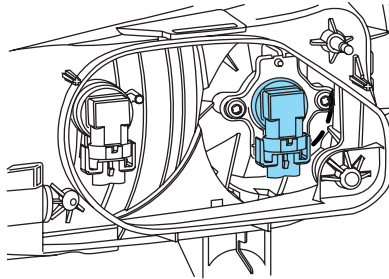

**Note:** The bulb's metal base gets very hot during headlamp operation. Be sure the bulb base is cool before handling.

**Note:** If the bulb is accidentally touched, it should be cleaned with rubbing alcohol before being used.

To complete installation, follow the removal procedure in reverse order.

## Lights

### **Replacing brake/tail/turn/backup lamp bulbs**

The brake/tail/turn/backup lamp bulbs are located in the tail lamp assembly, one just below the other. Follow the same steps to replace either bulb:

1. Make sure the headlamp switch is in the OFF position and then open the liftgate to expose the lamp assemblies.
2. Remove the two screws from the lamp assembly.
3. Carefully remove the lamp assembly by pulling it rearward to disengage snap features on the outward side of the lamp.
4. Twist the bulb socket counterclockwise and remove from lamp assembly.

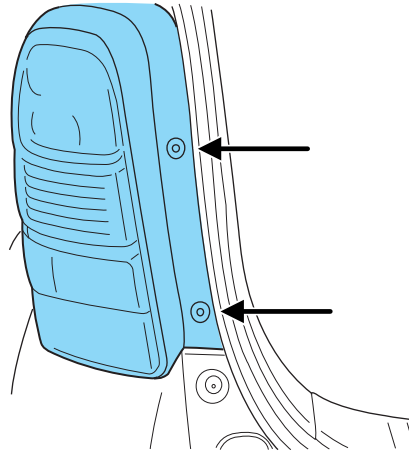

5. Pull the bulb straight out of the socket and push in the new bulb.
6. To complete installation, follow the removal procedure in reverse order.

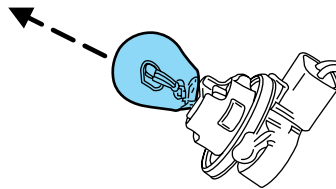

### **Replacing license plate lamp bulbs**

1. Make sure the headlamp switch is in the OFF position and then pry the license plate lamp assembly (located on each side above the license plate) from the liftgate.
2. Remove bulb socket from lamp assembly by turning counterclockwise.

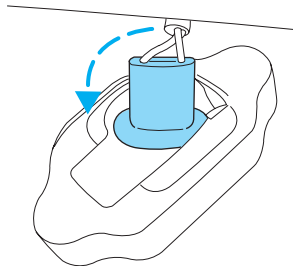

## Lights

3. Pull the bulb out from the socket and push in the new bulb.
4. Install the bulb socket in lamp assembly turning it clockwise.
5. To install, press the lamp assembly into liftgate.

### **Replacing high-mount brake lamp bulbs**

To remove the lamp assembly:

1. Remove the two screws and move the lamp assembly away from the liftgate.

2. Remove the bulb holder from the lamp assembly by depressing the snaps.

3. Pull the bulb straight out of the socket and push in the new bulb.

To complete installation, follow the removal procedure in reverse order.

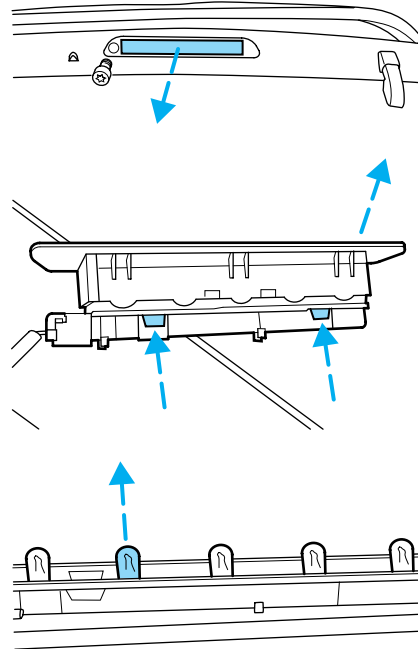

### **Replacing front parking lamp/turn signal bulbs**

For bulb replacement, see your authorized dealer.

### **Replacing foglamp bulbs**

For bulb replacement, see your authorized dealer.

## Driver Controls

### MULTI-FUNCTION LEVER

**Windshield wiper:** For intermittent operation, move control down one position.

Adjust the rotary control to the desired speed setting.

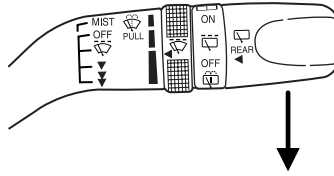

For normal or low speed wiper operation, move control down two positions from OFF.

For high speed wiper operation, move control down three positions from OFF.

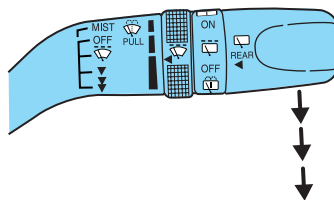

**Mist function:** To activate mist, push control up from the OFF position and release to get one wipe.

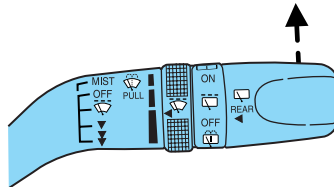

**Windshield washer:** To activate the windshield washer, pull control toward you. Release control to stop washer fluid spray.

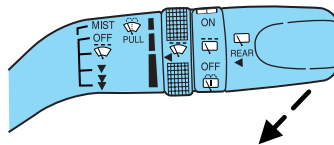

**Note:** Do not operate the washer when the washer reservoir is empty. This may cause the washer pump to overheat. Check the washer fluid level frequently. Do not operate the wipers when the windshield is dry. This may scratch the glass, damage the wiper blades and cause the wiper motor to burn out. Before operating the wiper on a dry windshield, always use the windshield washer. In freezing weather, be sure the wiper blades are not frozen to the windshield before operating the wipers.

## Driver Controls

### Rear window wiper/washer controls

For intermittent operation of rear wiper, rotate end of control upward to the  position.

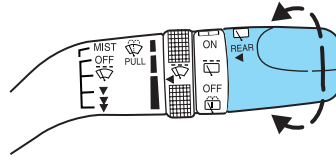

For normal speed rear wiper operation, rotate control upward to ON.

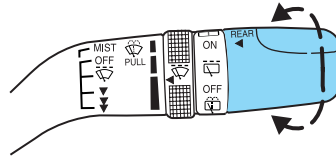

To activate the rear washer, rotate the control to the  position and release.

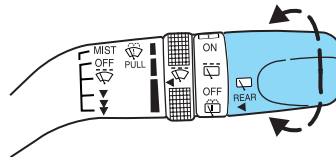

### TILT STEERING WHEEL

To adjust the steering wheel:

1. Pull down the steering column tilt lever.
2. Move the steering wheel up or down until you find the desired location.
3. Push the steering column tilt lever up. This will lock the steering wheel in position.

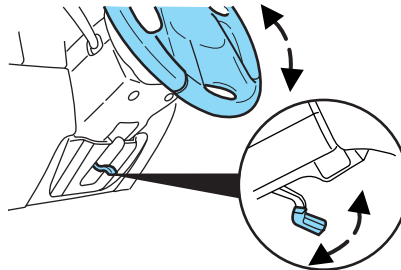

Never adjust the steering wheel when the vehicle is moving.

## Driver Controls

### ILLUMINATED VISOR MIRROR (IF EQUIPPED)

Lift the mirror cover to turn on the visor mirror lamps.

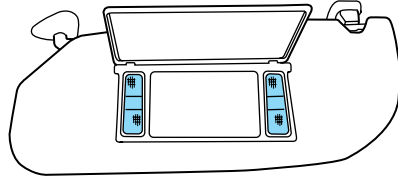

### CENTER CONSOLE

Your vehicle is equipped with a variety of console features. These include:

1. Power point
2. Cupholders
3. Utility compartment
4. Ash cup (if equipped)



Use only soft cups in the cupholders. Hard objects can injure you in a collision.

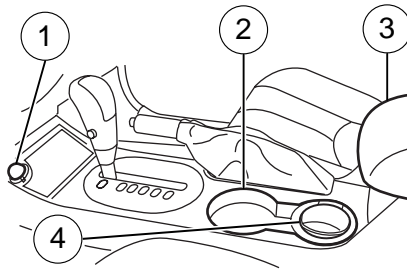

### AUXILIARY POWER POINT (12V)

**Power outlets are designed for accessory plugs only. Do not insert any other object in the power outlet as this will damage the outlet and blow the fuse. Do not hang any type of accessory or accessory bracket from the plug. Improper use of the power outlet can cause damage not covered by your warranty.**



## Driver Controls

The auxiliary power point is located in the floor console. Cigarette lighter (if equipped) is located in the instrument panel.

Do not use the power point for operating the cigarette lighter element (if equipped).

To prevent the fuse from being blown, do not use the power point(s) over the vehicle capacity of 12 VDC/180W.

To prevent the battery from being discharged, do not use the power point longer than necessary when the engine is not running.

Always keep the power point caps closed when not being used.

### **Cigar/Cigarette lighter (if equipped)**

Do not plug optional electrical accessories into the cigarette lighter socket.

Do not hold the lighter in with your hand while it is heating, this will damage the lighter element and socket. The lighter will be released from its heating position when it is ready to be used.

Improper use of the lighter can cause damage not covered by your warranty.

### **Power point (110 VAC) (if equipped)**

The 110 VAC power point outlet is used for powering electrical devices that require up to 150W. Exceeding the 150W limit will cause the power point to cut off the power temporarily to provide overload protection.

**Note:** The 110 VAC power point is equipped with a safety cap and a safety twist tab. They both provide protection from inserting any object into the power point other than the 110 VAC electrical device plug. The safety cap should always be in a closed position whenever the power point outlet is not in use.

The 110 VAC power point is located in the floor console in front of the gearshift.

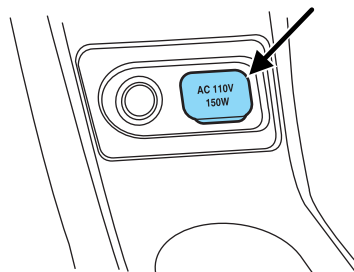
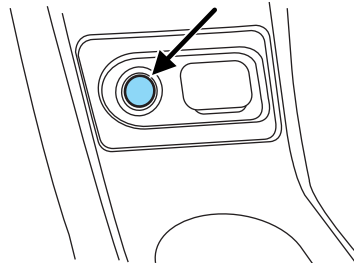

## Driver Controls

The power outlet is not designed for the following electric appliances; they may not work properly:

- Cathode ray tube type televisions.
- Motor loads, such as vacuum cleaners, electric saws and other electric power tools, compressor-driven refrigerators, etc.
- Measuring devices, which process precise data, such as medical equipment, measuring equipment, etc.
- Other appliances requiring an extremely stable power supply: microcomputer-controlled electric blankets, touch sensor lamps, etc.

**Do not keep electrical devices plugged in the power point whenever the device is not in use. It is not recommended to use any extension cord with the 110 VAC power point, since it will defeat the safety protection design provided by the cap and twist tab. It will also cause the power point to overload due to powering multiple devices that can reach beyond the 150W load limit.**

The power point can switch to a fault mode when it is overloaded, overheated, or shorted. For overloading and shorting conditions, unplug your device and turn the ignition key off then on. For an overheating condition, let the system cool off, then turn the ignition key off then on.

The 110 VAC power point can provide power whenever the vehicle ignition is in the run position and the power point green indicator light located in the top left corner is turned on. Refer to the indicator light code below for the power point status.

### Indicator light Code

Green light is On — Power point is ready to supply power

Green light is Off — Power point power supply is off. Ignition is not in RUN position

Green light is blinking — Power point is in fault mode

### POWER WINDOWS



Do not leave children unattended in the vehicle and do not let children play with the power windows. They may seriously injure themselves.

## Driver Controls

 When closing the power windows, you should verify they are free of obstructions and ensure that children and/or pets are not in the proximity of the window openings.

Press and hold the bottom part of the rocker switch to open the window. Press and hold the top part of the rocker switch to close the window.

**Note:** The window switches will not illuminate when the window lock control is in the LOCKED position.

**Rear Window Buffeting:** When one or both of the rear windows are open, the vehicle may demonstrate a wind throb or buffeting noise; this noise can be eliminated by lowering a front window approximately two to three inches.

### One touch down

Allows the driver's window to open fully without holding the control down. Press completely down on AUTO and release quickly. Press the top part of the switch to stop.

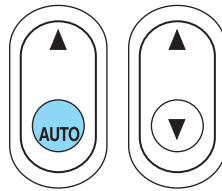
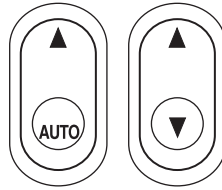

### Window lock (if equipped)

The window lock feature disables all the power windows except the driver's.

To lock out all the window controls except for the driver's window press the right side of the control.

**Note:** The passenger window switches will not illuminate when the window control is in the LOCKED position.

Press the left side to restore the window controls.

### Accessory delay

With accessory delay, the window switches, moon roof (if equipped) and audio system may be used for up to ten minutes after the ignition switch is turned to the OFF position or until either front door is opened.

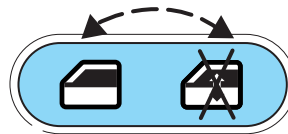

## Driver Controls

### EXTERIOR MIRRORS

#### Power side view mirrors

To adjust your mirrors:

1. Rotate the control, located on the instrument panel left of the steering wheel, clockwise to adjust the right mirror and rotate the control counterclockwise to adjust the left mirror.
2. Move the control in the direction you wish to tilt the mirror.
3. Rotate control to the center position to lock mirrors in place.

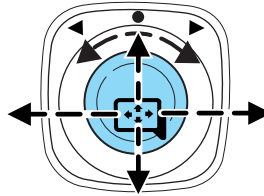

#### Fold-away mirrors

Fold the side mirrors in carefully when driving through a narrow space, like an automatic car wash.

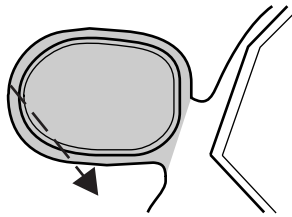

#### Heated outside mirrors (if equipped)

Both mirrors are heated automatically to remove ice, mist and fog when the rear window defrost is activated.

**Do not remove ice from the mirrors with a scraper or attempt to readjust the mirror glass if it is frozen in place.**

**These actions could cause damage to the glass and mirrors.**

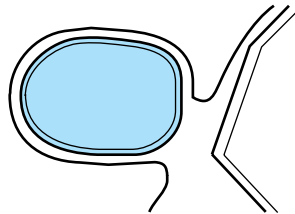

### SPEED CONTROL

With speed control set, you can maintain a speed of 30 mph (48 km/h) or more without keeping your foot on the accelerator pedal. Speed control does not work at speeds below 30 mph (48 km/h).

## Driver Controls



Do not use the speed control in heavy traffic or on roads that are winding, slippery or unpaved.

### Setting speed control

The controls for using your speed control are located on the steering wheel for your convenience.

1. Press the ON control and release it.
2. Accelerate to the desired speed.
3. Press the SET ACC control and release it.
4. Take your foot off the accelerator pedal.

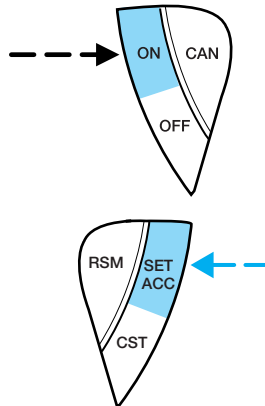

### Note:

- Vehicle speed may vary momentarily when driving up and down a steep hill.
- If the vehicle speed increases above the set speed on a downhill, you may want to shift into “L” gear and/or apply the brakes to reduce the speed.
- If the vehicle speed decreases more than 10 mph (16 km/h) below your set speed on an uphill, your speed control will disengage.

### Resuming a set speed

Press the RSM control and release it. This will automatically return the vehicle to the previously set speed. The RSM control will not work if the vehicle speed is not faster than 30 mph (48 km/h).

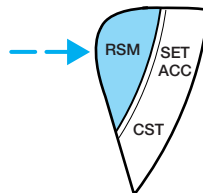

## Driver Controls

### **Increasing speed while using speed control**

There are two ways to set a higher speed:

- Press and hold the SET ACC control until you get to the desired speed, then release the control. You can also use the SET ACC control to operate the Tap-Up function. Press and release this control to increase the vehicle set speed in small amounts by 1 mph (2 km/h).
- Use the accelerator pedal to get to the desired speed. When the vehicle reaches that speed press and release the SET ACC control.

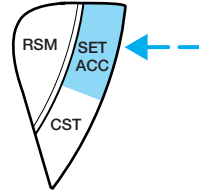

### **Reducing speed while using speed control**

There are two ways to reduce a set speed:

- Press and hold the CST control until you get to the desired speed, then release the control. You can also use the CST control to operate the Tap-Down function. Press and release this control to decrease the vehicle set speed in small amounts by 1 mph (2 km/h).
- Depress the brake pedal until the desired vehicle speed is reached, then press the SET ACC control.

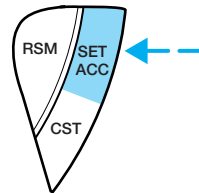
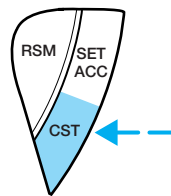

### **Disengaging speed control**

There are two ways to disengage the speed control:

- Depress the brake pedal. This will not erase your vehicle's previously set speed.

## Driver Controls

- Press the speed control CAN control.

**Note:** When you disengage the speed control, your speed control set speed memory is retained.

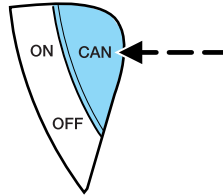

### **Turning off speed control**

Press the OFF control to turn off the speed control.

**Note:** When you turn off the speed control or the ignition, your speed control set speed memory is erased.

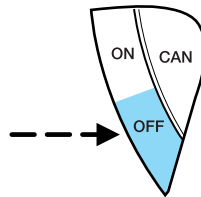

### **MOON ROOF (IF EQUIPPED)**

To operate the moon roof:

**Note:** The moon roof will open to the “comfort” position first before opening all the way. The “comfort” position helps to alleviate rumbling wind noise which may happen in the vehicle with the roof fully opened.

- The moon roof is equipped with an automatic, one-touch, express opening feature. Press and release the rear portion of the control. The moon roof will open to the “comfort” position. Press and hold the control again to fully open. To stop motion at any time during the one-touch opening, press the control again.
- To close, press and hold the front portion of the control.

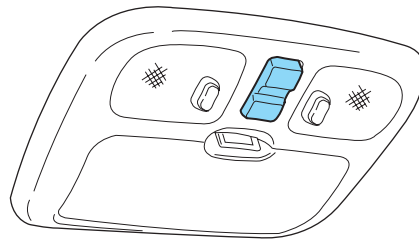

To operate the moon roof vent position:

- To open, press and hold the front portion of the control. This will open the vent.
- To close, press and hold the rear portion of the control.

**Note:** If the battery is disconnected, discharged, or a new battery is installed, the moon roof needs to be opened to the vent position to reset the moon roof positions.

## Driver Controls

If you open and close the moon roof repeatedly, the moon roof motor may overheat and shut down for 45 seconds while the motor cools.



Do not let children play with the moon roof or leave children unattended in the vehicle. They may seriously hurt themselves.



When closing the moon roof, you should verify that it is free of obstructions and ensure that children and/or pets are not in the proximity of the moon roof opening.

## MESSAGE CENTER

With the ignition in the RUN position, the message center, located on your instrument cluster, displays important vehicle and daily driving information **through a constant monitor of vehicle systems.** You may select display

features on the message center for a display of status preceded by a brief indicator chime. The system will also notify you of potential vehicle problems with a display of system warnings followed by an indicator chime.



XXXXXXXXXXXXXXXX  
XXXXXXXXXXXXXXXX

### Selectable features

#### Set

This button is used to select and reset various functions shown in the INFO Menu.

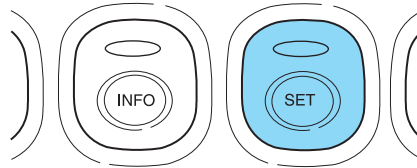



## Driver Controls

### Info menu

This control displays the following control displays:

- Average Fuel Economy (if equipped)
- Distance to Empty
- Instantaneous Fuel Economy (if equipped)
- High Voltage Battery Status
- System Check
- Units (English/Metric)
- Language
- INFO Display on/off

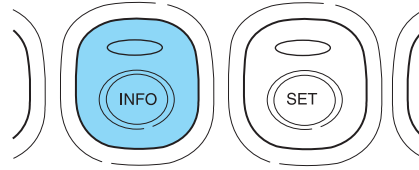

**Note:** If equipped with a Navigation Screen, the Average Fuel Economy and Instantaneous Fuel Economy will display in that screen instead of the message center display.

### Average fuel economy (AFE) (if equipped)

This function will display your average fuel economy in miles/gallon or liters/100 km.

If you calculate your average fuel economy by dividing gallons of fuel used by 100 miles traveled (kilometers traveled by liters used), your figure may be different than displayed for the following reasons:

- your vehicle was not perfectly level during fill-up
- differences in the automatic shut-off points on the fuel pumps at service stations
- variations in top-off procedure from one fill-up to another
- rounding of the displayed values to the nearest 0.1 gallon (liter)

1. Drive the vehicle at least 5 miles (8 km) with the speed control system engaged to display a stabilized average.

2. Record the highway fuel economy for future reference.

It is important to press the SET control after setting the speed control to get accurate highway fuel economy readings.



## Driver Controls

To reset back to zero, press and hold the SET button for 2 seconds.

### **Distance to empty (DTE)**

Selecting this function from the INFO menu will give you an estimate of how far you can drive with the fuel remaining in your tank under normal driving conditions.

Remember to turn the ignition

LOCK when refueling your vehicle. Otherwise, the display will not show the addition of fuel for a few kilometers (miles). DTE will vary according to your driving habits.



XXX MILES  
TO EMPTY

### **Instantaneous fuel economy (if equipped)**

Press INFO until the menu displays "INSTANT ECON". This will display your fuel economy as a Bar Graph ranging from "L" poor economy to "H" excellent economy.

Your vehicle must be moving to calculate instantaneous fuel economy. When your vehicle is not moving, this function shows "L", one or no bars illuminated. Instantaneous fuel economy cannot be reset.



INSTANT ECON  
L ■■■■■■■■■■ H

### **High Voltage Battery Status**

Select this function from the INFO menu for the state of charge of the high voltage battery. For a low battery "ELEC ENERGY AVAIL LOW" will be displayed and for normal operation "ELEC ENERGY AVAIL NORMAL" will be displayed.



ELEC ENERGY  
AVAIL NORMAL

### **System check**

Selecting this function from the INFO menu causes the message center to cycle through each of the systems being monitored. For each of the monitored systems, the message center will indicate either an OK message or a warning message for four seconds.

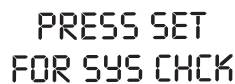

PRESS SET  
FOR SYS CHCK

## Driver Controls

Pressing the SET control cycles the message center through each of the systems being monitored. If you don't press any button, the system will cycle itself.

The sequence of the system check report is as follows:

1. Oil Change Reminder
2. HEV Hazard
3. HEV Caution
4. Charging System
5. Brake Fluid Level
6. Tire Pressure Monitoring System
7. Door Ajar Status
8. Exterior Lamps
9. Power Steering
10. 4 Wheel Drive (if equipped)

### **Units (English/Metric)**

1. Select this function from the INFO menu for the current units to be displayed.
2. Press the SET control to change the message display from English to Metric.



UNITS  
< ENG > METRIC

### **Language selection**

1. Select this function from the INFO menu for the current language to be displayed.



ENGLISH  
SET FOR NEW

2. Pressing the SET control cycles the message center through each of the language choices.



FOR ENGLISH  
HOLD SET

## Driver Controls

3. Press and hold the SET control for 2 seconds to set the language choice.

SET TO  
ENGLISH

### **Display On/Off**

Select this function from the INFO control to turn your message center display OFF or ON.

### **System warnings/information**

System warnings alert you to possible problems or malfunctions in your vehicle's operating systems.

In the event of a multiple warning situation, the message center will cycle the display to show all warnings by displaying each one for four seconds.

The message center will display the last selected feature if there are no more warning messages. This allows you to use the full functionality of the message center after you acknowledge the warning by pressing the SET control and clearing the warning message.

Warning messages that have been reset are divided into two categories:

- They will reappear on the display ten minutes from the reset.
- They will not reappear until an ignition LOCK-RUN cycle has been completed if the fault condition still exists.

This acts as a reminder that these warning conditions still exist within the vehicle.

Warnings	Status
Stop safely now	Warning cannot be reset
High engine temperature	
High motor temperature	
Hood ajar	
Driver door ajar	
Passenger door ajar	
Rear left door ajar	
Rear right door ajar	

## Driver Controls

Warnings	Status
Service soon	Warning returns after 10 minutes if condition still exist
Park brake on	
Liftgate ajar	Warning returns after the ignition key is turned from LOCK to RUN.
Service emission sys	
Check fuel cap	
Low brake fluid	
Service brake system	
Regen disabled	
Performance reduced	
Low tire pressure	
Tire pressure monitor fault	
Tire pressure sensor fault	
Check left headlamp	
Check right headlamp	
Check left high beam	
Check right high beam	
Check left turn lamps	
Check right turn lamps	
Check brake lamps	
Engine oil change soon	
Engine oil change now reminder	
Low fuel	
Service pwr steering	
Service 4 X 4	
Turn signal on (if equipped)	
Speed control on	
4X4 locked temporarily	Temporary alert
4X4 disabled temporarily	
4X4 auto restored	

## Driver Controls

**STOP SAFELY NOW.** Displayed when the Master electrical hazard warning lamp is illuminated indicating a Hybrid component failure. If this warning occurs, the vehicle will soon shutdown without further warning, stop the vehicle as soon as safely possible and contact your authorized dealer as soon as possible.

**HIGH ENGINE TEMPERATURE.** Displayed when the engine coolant is overheating. Engine coolant temperature warning lamp will illuminate indicating coolant temperature is high. Stop the vehicle as soon as safely possible, turn off the engine and let it cool. Check the coolant and coolant level. Refer to *Engine coolant* in the *Maintenance and Specifications* chapter. If the warning stays on or continues to come on, contact your authorized dealer as soon as possible.



Never remove the coolant reservoir cap while the engine is running or hot.

**HIGH MOTOR TEMPERATURE.** Displayed when the motor electronics are overheating. Stop the vehicle as soon as safely possible, turn off the engine and let it cool. Refer to *Engine coolant and motor/electronics coolant* in the *Maintenance and Specifications* chapter. If the warning stays on or continues to come on, contact your authorized dealer as soon as possible.

**PERFORMANCE REDUCED.** Displayed when the vehicle performance is reduced due to failsafe cooling.

**HOOD AJAR.** Displayed when the hood is not completely closed.

**DRIVER DOOR AJAR.** Displayed when the driver door is not completely closed.

**PASSENGER DOOR AJAR.** Displayed when the passenger door is not completely closed.

**REAR LEFT DOOR AJAR.** Displayed when the rear left door is not completely closed.

**REAR RIGHT DOOR AJAR.** Displayed when the rear right door is not completely closed.

**LIFTGATE AJAR.** Displayed when the liftgate or liftgate glass is not completely closed. Press SET to reset display.

**SERVICE SOON.** Displayed when service lamp (yellow wrench ) is activated. If the warning or indicator light stays on or continues to come on, contact your authorized dealer as soon as possible.

**PARK BRAKE ON.** Displayed when the park brake is on. If the warning and indicator light stays on after the park brake is off, contact your authorized dealer as soon as possible.

## Driver Controls

**SERVICE EMISSION SYS.** Displayed when the vehicle has detected a malfunction. If the warning stays on or continues to come on, contact your authorized dealer as soon as possible.

**CHECK FUEL CAP.** Displayed when the fuel filler cap is not properly installed. Check the fuel filler cap for proper installation. Refer to *Fuel filler cap* in the *Maintenance and Specifications* chapter.

**SERVICE BRAKE SYSTEM.** Displayed when the braking system is not operating properly. If the warning stays on or continues to come on, contact your authorized dealer as soon as possible.

**REGEN DISABLED.** Indicates the regenerative braking system is disabled at this moment. Please see your authorized dealer if this warning remains present over several days.

**SERVICE PWR STEERING.** Displayed when the power steering system is not operating properly. If this warning and the  service soon indicator light stays on or continues to come on, contact your authorized dealer for service as soon as possible.

**LOW TIRE PRESSURE.** Displayed when one or more tires on your vehicle have low tire pressure. Refer to *Inflating Your Tires* in the *Tires, Wheels and Loading* chapter.

**TIRE PRESSURE MONITOR FAULT.** Displayed when the Tire Pressure Monitoring System is malfunctioning. If the warning stays on or continues to come on, have the system inspected by your authorized dealer.

**TIRE PRESSURE SENSOR FAULT.** Displayed when a tire pressure sensor is malfunctioning, or your spare tire is in use. For more information on how the system operates under these conditions, refer to *Understanding Your Tire Pressure Monitoring System* in the *Tires, Wheels and Loading* chapter. If the warning stays on or continues to come on, have the system inspected by your authorized dealer.

**CHECK LEFT OR RIGHT HEADLAMPS.** Displayed when the headlamps are activated and at least one is burned out. Check the lamps as soon as possible and have the burned out lamp replaced. Refer to *Replacing headlamp bulbs* in the *Lights* chapter.

**CHECK LEFT OR RIGHT HIGH BEAMS.** Displayed when the headlamps are activated and at least one is burned out. Check the lamps as soon as possible and have the burned out lamp replaced. Refer to *Replacing headlamp bulbs* in the *Lights* chapter.

**CHECK LEFT OR RIGHT TURN LAMPS.** Displayed when the turn signals are activated and at least one is burned out. Check the lamps as soon as safely possible and have the burned out lamp replaced.

## Driver Controls

**LOW FUEL.** Displayed as an early reminder of a low fuel condition. The function will display “LOW FUEL LEVEL” and sound a tone for one second when you have low fuel level indicated on the fuel gauge.

**SERVICE 4X4.** Displayed when the 4X4 is not operating properly. If the warning stays on or continues to come on, contact your authorized dealer as soon as possible.

**TURN SIGNAL ON (if equipped).** Displayed when the turn signal is activated and the vehicle is driven more than 2 miles (3.3 km).

**SPEED CONTROL ON.** Displayed when the speed control is activated.

**4X4 LOCKED TEMPORARILY.** Displayed when the 4X4 is temporarily locked. No service is required.

**4X4 DISABLED TEMPORARILY.** Displayed when the 4X4 is temporarily disabled. No service is required.

**4X4 AUTO RESTORED.** Displayed when the 4X4 is restored to normal operations.

**ENGINE OIL CHANGE SOON/ENGINE OIL CHANGE NOW REMINDER.** Displayed when the engine oil life remaining is 5% or less. When oil life left is between 5% and 0%, the ENGINE OIL CHANGE SOON message will be displayed. When oil life left reaches 0%, the ENGINE OIL CHANGE NOW message will be displayed.

An oil change is required whenever indicated by the message center. USE ONLY RECOMMENDED ENGINE OILS.

To reset the oil monitoring system to 100% after each oil change (approximately 10,000 miles [16,000 km] or 12 months) perform the following:

1. Select this function from the INFO menu then press the SET control to access the system check function.

PRESS SET  
FOR SYS CHCK

2. Press and release the SET control to display “OIL CHNG XXX% HOLD SET NEW”.

OIL CHNG XXX%  
HOLD SET NEW



## Driver Controls

3. Press and hold the SET control for 2 seconds to display “OIL CHANGE SET TO 100%”.

**Note:** This feature is based on distance traveled or time elapsed since last reset. You must reset this feature every oil change to ensure accuracy

OIL CHANGE  
SET TO 100%

**DATA ERR.** These messages indicate improper operation of the vehicle network communication between electronic modules.

- Fuel computer
- Oil life
- Charging system
- Door sensor
- Washer fluid
- Brake fluid
- Engine sensor

Contact your authorized dealer as soon as possible if these messages occur on a regular basis.

### LIFTGATE

To open the rear window, pull the right side of the liftgate handle.

To open the liftgate, pull the left side of the liftgate handle.

- Do not open the liftgate or liftgate glass in a garage or other enclosed area with a low ceiling. If the liftgate glass is raised and the liftgate is also opened, both liftgate and glass could be damaged against a low ceiling.
- Do not leave the liftgate or liftgate glass open while driving. Doing so could cause serious damage to the liftgate and its components as well as allowing carbon monoxide to enter the vehicle.

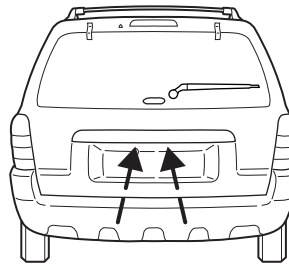

## Driver Controls

 Make sure that the liftgate door and/or window are closed to prevent exhaust fumes from being drawn into the vehicle. Exhaust fumes contain carbon monoxide which can injure your lungs and cause drowsiness and even death. This will also prevent passengers and cargo from falling out. If you must drive with the liftgate door or window open, keep the vents open so outside air comes into the vehicle.

### CARGO SHADE (IF EQUIPPED)

If your vehicle has a cargo shade, you can use it to cover items in the cargo area of your vehicle.

To operate the shade:

- Insert the ends of the cargo shade into the mounting features located behind the rear seat on the rear trim panels.

To operate the shade:

1. Grasp the rear edge of the cargo shade and pull rearward.
2. Secure both ends of the support rod into the retention slots located on the rear quarter trim panels.

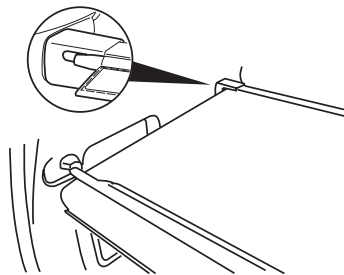

 Ensure that the posts are properly latched in mounting features. The cover may cause injury in a sudden stop or accident if it is not securely installed.

 Do not place any objects on the cargo area shade. They may obstruct your vision or strike occupants of vehicle in the case of a sudden stop or collision.

## Driver Controls

### LUGGAGE RACK

Your vehicle may be equipped with a roof rack. The maximum load for the roof rack is 100 lbs (44 kg), evenly distributed on the cross-bars. If it is not possible to evenly distribute the load, position it in the center or as far forward on the cross-bars as possible.

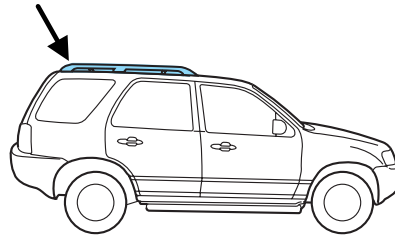

**Do not use the vehicle's door handles as tie down loops.**

#### ***To adjust the cross-bar (if equipped) position:***

1. Loosen the thumbwheel at both ends of the cross-bar (both cross-bars are adjustable).
2. Slide the cross-bar to the desired location.
3. Tighten the thumbwheel at both ends of the cross-bar.

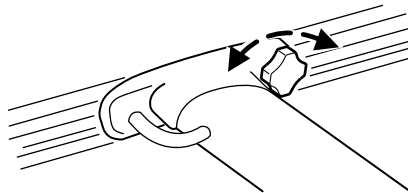

#### ***To remove the cross-bar assembly (if equipped) from the roof rack side rails:***

1. Loosen the thumbwheel at both ends of the cross-bar (both cross-bars are adjustable).

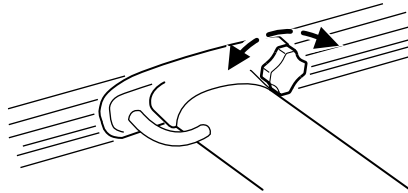

2. Slide the cross-bar to the end of the rail.

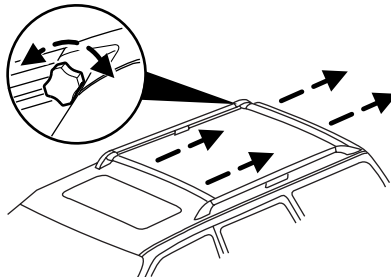

## Driver Controls

3. Use a long, flat object to depress the tongue in the endcaps on both sides of the cross-bar.
4. Slide the cross-bar assembly off the end of the rail.

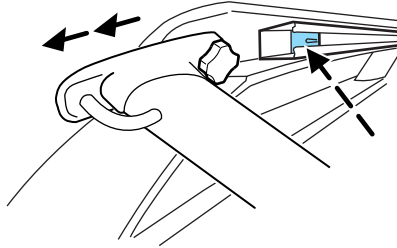

### **To reinstall the cross-bar assembly (if equipped) to the roof rack side rails:**

1. Ensure that both cross-bar assemblies are installed with the F (front) arrow facing towards the front of the vehicle.
2. Use a long, flat object to depress the tongue in the endcaps on both sides of the cross-bar.
3. Slide the cross-bar assemblies over the end cap tongue and into the side rails.
4. Tighten thumbwheel at both ends of the cross-bar.

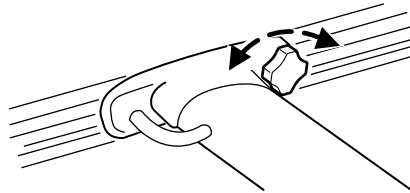
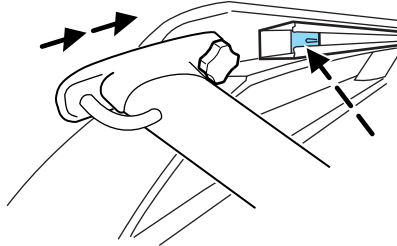

## Locks and Security



### KEYS

One key operates all locks and starts the vehicle. Always carry a spare key with you in case of an emergency.

Your keys are programmed to your vehicle; using a non-programmed key will not permit your vehicle to start. If you lose your authorized dealer supplied keys, replacement keys are available through your authorized dealer. Refer to the *SecuriLock<sup>™</sup> passive anti-theft system* section in this chapter for more information.

### POWER DOOR LOCKS

The power door lock controls are located on the driver and front passenger door panels.

Pressing the  will unlock all the doors. Pressing the  will lock all the doors.

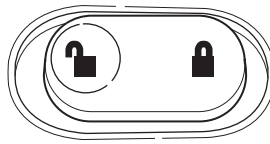

### Power door lock/unlock inhibit feature

As a theft deterrent, the power door lock controls can be disabled 20 seconds after the ignition has been turned to the 1 (LOCK) position and the vehicle is locked using the remote entry transmitter or the key in the door lock cylinder. The door lock controls are enabled when the vehicle is unlocked using the key in the door lock cylinder or by pressing  on the remote entry transmitter. This feature can be turned on or off using the following procedure:

Before starting, ensure the ignition is in the 1 (LOCK) position and all vehicle doors are closed. You must complete Steps 1–5 within 30 seconds or the procedure will have to be repeated.

1. Place the key in the ignition and turn the ignition to the 3 (RUN) position.
2. Press the power door unlock control on the door panel three times.
3. Turn the ignition from the 3 (RUN) position to the 1 (LOCK) position.
4. Press the power door unlock control on the door panel three times.
5. Turn the ignition back to the 3 (RUN) position. The horn will chirp one time to confirm programming mode has been entered and is active.
6. Press the power door lock control on the door panel two times within five seconds. The horn will chirp two times to confirm the feature is off; the horn will chirp two times and honk one time to confirm the feature is on.

## Locks and Security

7. Turn the ignition from the 3 (RUN) position to the 1 (LOCK) position. The horn will chirp one time to confirm the programming mode has been exited.

Repeat the procedure to turn the feature on or off.

### Door key unlocking/locking

#### **Two step door unlocking**

1. Turn the key in the door cylinder to unlock the driver's door. **Note:** The interior lamps will illuminate if the control on the overhead lamp is in the DOOR position and the perimeter alarm system (if equipped) will deactivate. For more information, refer to *Illuminated entry* later in this chapter.

2. Turn the key in the door cylinder again within three seconds to unlock the passenger doors, the liftgate and liftgate glass.

#### **One step door unlocking**

If the one step door unlocking feature is activated, turn the key in the door cylinder once to unlock all of the doors, the liftgate and liftgate glass. **Note:** The interior lamps will illuminate (refer to the *Illuminated entry* feature later in this section), if the control on the overhead lamp is in the DOOR position. For information on switching from two step to one step door unlocking, refer to *Switching from two step to one step door unlocking* later in this chapter.

#### **Locking the doors**

Turn the key in the door cylinder to lock all the doors. The park/turn lamps will flash once and the perimeter alarm (if equipped) will start the arming process. For more information concerning the perimeter alarm, refer to *Perimeter alarm system (if equipped)* later in this chapter.

If any of the doors, the liftgate or the hood are not properly closed the park/turn lamps will not flash.

#### **Autolock (if equipped)**

The autolock feature automatically locks all vehicle doors when:

- all doors are closed,
- the ignition is in the 3 (RUN) position,
- the brake has been released, and
- the vehicle has been set in motion.

## Locks and Security

### **Relock**

This feature will also automatically relock all the doors when:

- the ignition is in the 3 (RUN) position and any door is opened then closed, and
- you put the vehicle in motion by releasing the brake pedal.

### **Deactivating/activating the autolock feature**

The autolock feature can be activated or deactivated using the following procedure:

Before starting, make sure that the ignition is in the 1 (LOCK) position and all vehicle doors are closed.

You must complete Steps 1–5 within 30 seconds or the procedure will have to be repeated.

1. Turn the ignition to the 3 (RUN) position.
2. Press the power door unlock control on the door panel three times.
3. Turn the ignition from the 3 (RUN) position to the 1 (LOCK) position.
4. Press the power door unlock control three times.
5. Turn the ignition from the 1 (LOCK) position to the 3 (RUN) position.
6. The horn will chirp once to confirm programming mode is entered/active.
7. Press the power door unlock control on the door panel one time.
8. Press the power door lock control on the door panel one time. **Note:** The horn will chirp once to confirm the feature is OFF, or the horn will chirp and then honk to confirm the feature is ON.
9. Turn the ignition to the 1 (LOCK) position. **Note:** The horn will chirp once to confirm the programming mode has been exited.

Repeat the previous procedure to turn the feature on or off.

### **Smart unlocking feature**

The smart unlocking feature helps prevent you from locking yourself out of the vehicle. With the key in any ignition position, the driver's door will automatically unlock if it is locked using the power lock control on the driver's door panel while the driver's door is open.

## Locks and Security

### CHILDPROOF DOOR LOCKS

- When these locks are set, the rear doors cannot be opened from the inside.
- The rear doors can be opened from the outside when the doors are unlocked.

The childproof locks are located on rear edge of each rear door and must be set **separately** for each door. Setting the lock for one door will **not** automatically set the lock for both doors.

- Rotate lock control in the direction of arrow to engage the lock.
- Rotate control in the opposite direction to disengage childproof locks.

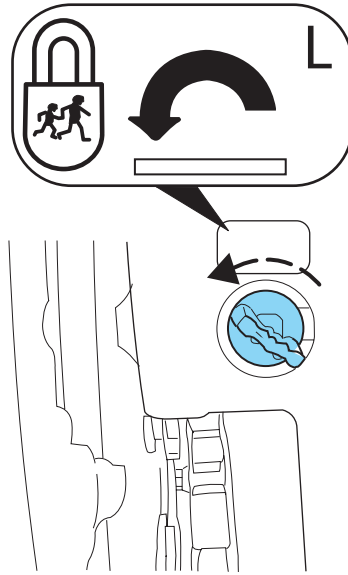

### REMOTE ENTRY SYSTEM (IF EQUIPPED)

This device complies with part 15 of the FCC rules and with RS-210 of Industry Canada. Operation is subject to the following two conditions: (1) This device may not cause harmful interference, and (2) This device must accept any interference received, including interference that may cause undesired operation.

**Changes or modifications not expressly approved by the party responsible for compliance could void the user's authority to operate the equipment.**

The typical operating range for your remote entry transmitter is approximately 33 feet (10 meters). A decrease in operating range could be caused by:

- weather conditions,
- nearby radio towers,
- structures around the vehicle, or
- other vehicles parked next to your vehicle.



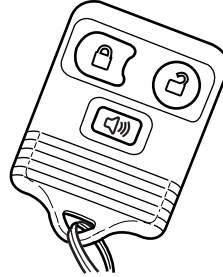

## Locks and Security

The remote entry system allows you to lock or unlock all vehicle doors without a key. The remote locking and unlocking features will operate independent of the ignition position; however, the panic feature will only operate when the ignition is in the 1 (LOCK) or 2 (ACCESSORY) position.



If there are problems with the remote entry system, make sure to take **ALL remote entry transmitters** with you to the authorized dealer in order to aid in troubleshooting the problem.



### Two step door unlocking

1. Press  and release to unlock the driver's door. **Note:** The interior lamps will illuminate if the lamp is in the DOOR position and the perimeter alarm system (if equipped) will deactivate.
2. Press  and release again within three seconds to unlock the passenger doors, the liftgate and liftgate glass.

### One step door unlocking

If the one step door unlocking feature is activated, press  and release once to unlock all of the doors, the liftgate and liftgate glass. **Note:** The interior lamps will illuminate (refer to *Illuminated entry* information later in this section), if the control on the overhead lamp is in the DOOR position and the perimeter alarm system (if equipped) will deactivate.

### Switching from two step to one step door unlocking

Unlocking can be switched between two step and one step door unlocking by pressing and holding both  and  buttons simultaneously on the remote entry transmitter for approximately 4 seconds. The parklamps will flash twice to indicate that the vehicle has switched to one step unlocking. Repeat the procedure to switch back to two step unlocking.

### Locking the doors

1. Press  and release to lock all the doors. Assuming all vehicle doors and the liftgate are properly closed, the park/turn lamps will flash once and the perimeter alarm (if equipped) will start the arming process.

## Locks and Security

For more information concerning the perimeter alarm, refer to *Perimeter alarm system (if equipped)* later in this chapter.

2. Press  and release again within three seconds to confirm that all the doors and liftgate are closed and locked. **Note:** The doors will lock again and the horn will chirp once.

If any of the doors or the hood are not properly closed, the horn will chirp twice and park/turn lamps will not flash when the  control is pressed.

### Sounding a panic alarm

Press  to activate the alarm. To deactivate the feature, press the control again, turn the ignition to the 3 (RUN) or 4 (START) position, or wait for the alarm to time out in approximately 3 minutes.

**Note:** The panic alarm will only operate when the ignition is in the 1 (LOCK) position.

### Replacing the battery

The remote entry transmitter uses one coin type three-volt lithium battery CR2032 or equivalent.

To replace the battery:

1. Twist a thin coin between the two halves of the remote entry transmitter near the key ring. DO NOT TAKE THE RUBBER COVER AND CIRCUIT BOARD OFF THE FRONT HOUSING OF THE REMOTE ENTRY TRANSMITTER.

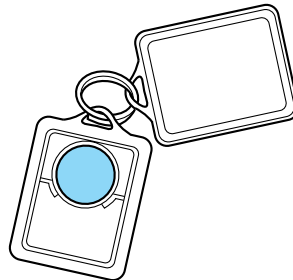

## Locks and Security

2. Do not wipe off any grease on the battery terminals on the back surface of the circuit board.

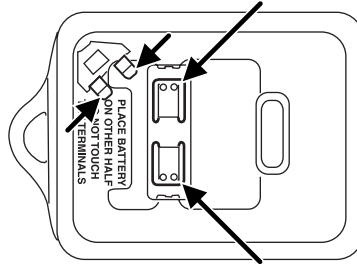

3. Remove the old battery. **Note:** Please refer to local regulations when disposing of transmitter batteries.

4. Insert the new battery. Refer to the diagram inside the remote entry transmitter for the correct orientation of the battery. Press the battery down to ensure that the battery is fully seated in the battery housing cavity.

5. Snap the two halves back together.

**Note:** Replacement of the battery will **not** cause the remote transmitter to become deprogrammed from your vehicle. The remote transmitter should operate normally after battery replacement.

### Replacing lost remote entry transmitters

If you would like to have your remote entry transmitter reprogrammed because you lost one, or would like to buy additional remote entry transmitters, you can either reprogram them yourself, or take **all remote entry transmitters** to your authorized dealer for reprogramming.

### *How to reprogram your remote entry transmitters*

You must have **all remote entry transmitters** (maximum of four) available before beginning this procedure. If all remote entry transmitters are not present during the programming procedure, the transmitters that are not present during programming will no longer operate the vehicle.

## Locks and Security

**Note:** Ensure the brake pedal is not depressed during this sequence.

To reprogram the remote entry transmitters:

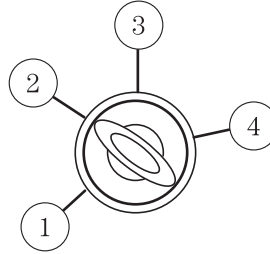

1. Ensure the vehicle is electronically unlocked.
2. Put the key in the ignition.
3. Turn the key from the 1 (LOCK) position to 3 (RUN).
4. Cycle eight times rapidly (within 10 seconds) between the 1 (LOCK) position and 3 (RUN). **Note:** The eighth turn must end in the 3 (RUN) position.
5. The doors will lock, then unlock, to confirm that the programming mode has been activated.
6. Within 20 seconds press any button on the remote entry transmitter. **Note:** If more than 20 seconds have passed you will need to start the procedure over again.
7. The doors will lock, then unlock, to confirm that this remote entry transmitter has been programmed.
8. Repeat Step 6 to program each additional remote entry transmitter.
9. Turn the ignition to the 1 (LOCK) position after you have finished programming all of the remote entry transmitters.
10. The doors will lock, then unlock, to confirm that the programming mode has been exited.

### Illuminated entry

The interior lamps illuminate when the remote entry system is used to unlock the door(s).

The illuminated entry system will turn off the interior lights if:

- the ignition switch is turned to the 2 (ACCESSORY) position, or
- the remote transmitter lock control is pressed, or
- the doors are locked by key in the door cylinder, or

## Locks and Security

- after 25 seconds of illumination.

### **Illuminated exit**

- The interior lights will illuminate when the key is removed from the ignition.

The lamps automatically turn off after 25 seconds. The dome and cargo lamp controls must **not** be set to the OFF position for the illuminated exit system to operate.

### **SECURILOCK™ PASSIVE ANTI-THEFT SYSTEM**

SecuriLock™ passive anti-theft system is an engine immobilization system. This system is designed to help prevent the engine from being started unless a **coded key programmed to your vehicle** is used. The use of the wrong type of coded key may lead to a “no-start” condition.

Your vehicle comes with two coded keys; additional coded keys may be purchased from your authorized dealer. The authorized dealer can program your spare keys to your vehicle or you can program the keys yourself. Refer to *Programming spare keys* for instructions on how to program the coded key.

**Note:** The SecuriLock™ passive anti-theft system is not compatible with non-Ford aftermarket remote start systems. Use of these systems may result in vehicle starting problems and a loss of security protection.

**Note:** Large metallic objects, electronic devices that are used to purchase gasoline or similar items, or a second coded key on the same key chain may cause vehicle starting issues. You need to prevent these objects from touching the coded key while starting the engine. These objects will not cause damage to the coded key, but may cause a momentary issue if they are too close to the key when starting the engine. If a problem occurs, turn the ignition off, remove all objects on the key chain away from the coded key and restart the engine.

### **Anti-theft indicator**

The anti-theft indicator is located in the instrument cluster.

## **THEFT**

- When the ignition is in the 1 (LOCK) position, the anti-theft indicator will flash once every 2 seconds to indicate the SecuriLock™ system is functioning as a theft deterrent.
- When the ignition is in the 3 (RUN) position, the anti-theft indicator will glow for 3 seconds, then turn off to indicate normal system functionality.

## Locks and Security

If a problem occurs with the SecuriLock<sup>™</sup> system, the indicator will flash rapidly or glow steadily when the ignition is in the 3 (RUN) position. If this occurs, the vehicle should be taken to an authorized dealer for service.

### Replacement keys

If your keys are lost or stolen and you don't have an extra coded key, you will need to have your vehicle towed to an authorized dealer. The key codes need to be erased from your vehicle and new coded keys will need to be programmed.

Replacing coded keys can be very costly. Store an extra programmed key away from the vehicle in a safe place to help prevent any inconveniences. Please visit an authorized dealer to purchase additional spare or replacement keys.

### Programming spare keys

You can program your own coded keys to your vehicle.

#### Tips:

- A maximum of eight keys can be coded to your vehicle.
- Only use SecuriLock<sup>™</sup> keys.
- You must have two previously programmed coded keys (keys that already operate your vehicle's engine) and the new unprogrammed key(s) readily accessible.
- If two previously programmed coded keys are not available, you must take your vehicle to your authorized dealer to have the spare key(s) programmed.

Please read and understand the entire procedure before you begin.

1. Insert the first previously programmed **coded key** into the ignition.

2. Turn the ignition from the 1 (LOCK) position to the 3 (RUN) position. Keep the ignition in the 3 (RUN) position for at least three seconds, but no more than 10 seconds.

3. Turn the ignition to the 1 (LOCK) position and remove the first **coded key** from the ignition.

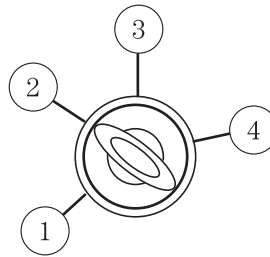

## Locks and Security

4. Within ten seconds of turning the ignition to the 1 (LOCK) position, insert the second previously **coded key** into the ignition.
5. Turn the ignition from the 1 (LOCK) position to the 3 (RUN) position. Keep the ignition in the 3 (RUN) position for at least three seconds, but no more than 10 seconds.
6. Turn the ignition to the 1 (LOCK) position and remove the second previously programmed **coded key** from the ignition.
7. Within twenty seconds of turning the ignition to the 1 (LOCK) position and removing the previously programmed **coded key**, insert the new unprogrammed key (new key/valet key) into the ignition.
8. Turn the ignition from the 1 (LOCK) position to the 3 (RUN) position. Keep the ignition in the 3 (RUN) position for at least three seconds but not more than 10 seconds.
9. Remove the newly programmed **coded key** from the ignition.

If the key has been successfully programmed it will start the vehicle's engine and the theft indicator light will illuminate for three seconds and then go out.

If the key was not successfully programmed, it will not start your vehicle's engine and the theft indicator light will flash on and off; you may need to repeat Steps 1 through 5. If failure repeats, bring your vehicle to your authorized dealer to have the new key(s) programmed.

To program additional new unprogrammed key(s), wait twenty seconds and then repeat this procedure from Step 1.

### PERIMETER ALARM SYSTEM (IF EQUIPPED)

The perimeter anti-theft system will warn you in the event of an unauthorized entry to your vehicle.

If there is any potential perimeter anti-theft problem with your vehicle, ensure **ALL remote entry transmitters** are taken to the authorized dealer to aid in troubleshooting.

### Arming the system

When armed, this system will respond if unauthorized entry is attempted. When unauthorized entry occurs, the system will flash the park/turn lamps and will sound the horn.

The system is ready to arm whenever the key is removed from the ignition. Any of the following actions will prearm the alarm system:

- Press the  control on the remote entry transmitter.

## Locks and Security

- Lock the doors with the key in the key cylinder.
- Open the driver's door and press the power door lock control to lock all the doors, and then close the door.

**Note:** The doors, liftgate and hood will arm individually, and if any of them are open, they must be closed in order to be armed.

When you lock the vehicle using any of the methods above:

- the park/turn lamps will flash once to indicate the hood, each door and the liftgate are closed.
- the park/turn lamps will **not** flash if the hood, any door or the liftgate are open. Once all doors, hood and liftgate are closed, the park/turn lamps will flash to confirm the alarm will be set.

When the vehicle is locked, the alarm is set after a 20-second arming period.

When you press the  control on the remote entry transmitter twice within three seconds, the horn will chirp once to confirm the doors, liftgate and hood are closed and locked, and the alarm is set.

### Disarming the system



You can disarm the system by any of the following actions:

- Unlock the doors by pressing the  control on your remote entry transmitter.
- Unlock the doors with a key. Turn the key full travel (toward the front of the vehicle) to ensure the alarm disarms.
- Turning the key in the ignition to the 3 (RUN) or 4 (START) position.

### Triggering the anti-theft system

The armed system will be triggered if any door, liftgate or the hood is opened without using the key or the remote entry transmitter.

To deactivate the triggered alarm state:

- Unlock the doors by pressing the  control on your remote entry transmitter.
- Unlock the doors with a key. Turn the key full travel (toward the front of the vehicle) to ensure the alarm disarms.
- Press  on the remote entry transmitter to disable the alarm; the alarm will be disabled, but the vehicle will remain in an armed state.
- Turning the key in the ignition to the 3 (RUN) or 4 (START) position.

120



## Seating and Safety Restraints

### FRONT SEATS

#### Notes:



Reclining the seatback can cause an occupant to slide under the seat's safety belt, resulting in severe personal injuries in the event of a collision.



Do not pile cargo higher than the seatbacks to reduce the risk of injury in a collision or sudden stop.



Before returning the seatback to its original position, make sure that cargo or any objects are not trapped behind the seatback. After returning the seatback to its original position, pull on the seatback to ensure that it has fully latched. An unlatched seat may become dangerous in the event of a sudden stop or collision.

### Adjustable head restraints

The purpose of these head restraints is to help limit head motion in the event of a rear collision. To properly adjust your head restraints, lift the head restraint so that it is located directly behind your head or as close to that position as possible.

The head restraints can be moved up and down.

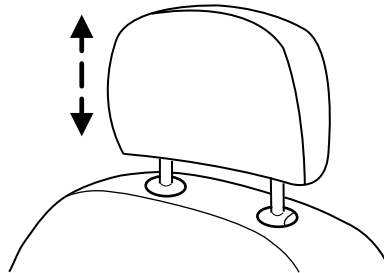

## Seating and Safety Restraints

Push side control and push down on head restraint to lower it.

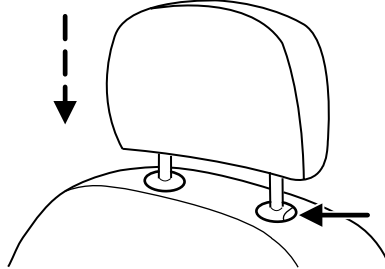

### Adjusting the front manual seat (if equipped)

Lift handle to move seat forward or backward.

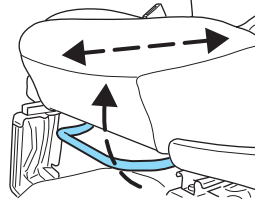

Pull lever up to adjust seatback.

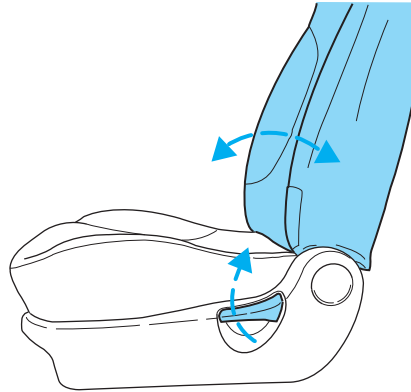

### Adjusting the front power seat (if equipped)



Never adjust the driver's seat or seatback when the vehicle is moving.

## Seating and Safety Restraints



Do not pile cargo higher than the seatbacks to avoid injuring people in a collision or sudden stop.



Always drive and ride with your seatback upright and the lap belt snug and low across the hips.



Reclining the seatback can cause an occupant to slide under the seat's safety belt, resulting in severe personal injuries in the event of a collision.



Sitting improperly out of position or with the seat back reclined too far can take off weight from the seat cushion and affect the decision of the passenger sensing system, resulting in serious injury or death in a crash. Always sit upright against your seatback, with your feet on the floor.



To reduce the risk of possible serious injury: Do not hang objects off seat back or stow objects in the seatback map pocket (if equipped) when a child is in the front passenger seat. Do not place objects underneath the front passenger seat or between the seat and the center console (if equipped). Check the “passenger airbag off” or “pass airbag off” indicator lamp for proper airbag status. Refer to *Front passenger sensing system* section for additional details. Failure to follow these instructions may interfere with the front passenger seat sensing system.

The control is located on the outboard side of the seat cushion.

Press to raise or lower the front portion of the seat cushion.

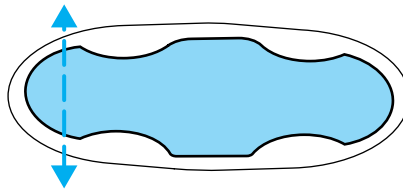

## Seating and Safety Restraints

Press to raise or lower the rear portion of the seat cushion.

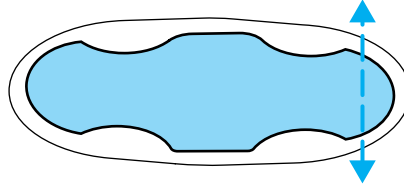

Press the control to move the seat forward, backward, up or down.

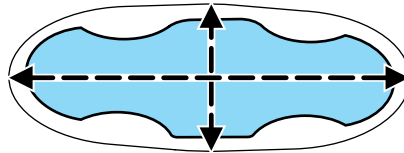

### Heated seats (if equipped)

To operate the heated seats:

- Push the control located on the seat to activate.
- Push again to deactivate.

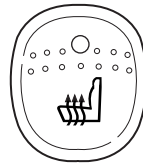

The heated seats will activate when the ignition is in the RUN position.

## REAR SEATS

### Head restraints

The purpose of these head restraints is to help limit head motion in the event of a rear collision. To properly adjust your head restraints, lift the head restraint so that it is located directly behind your head or as close to that position as possible.

## Seating and Safety Restraints

The head restraints can be moved up and down. Lift the head restraint so that it is located directly or as close as possible behind your head.

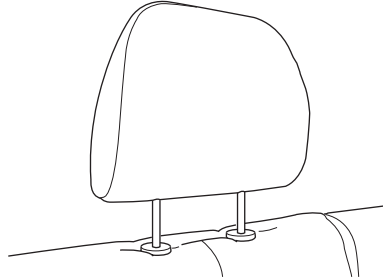

Push control to lower or remove head restraint.

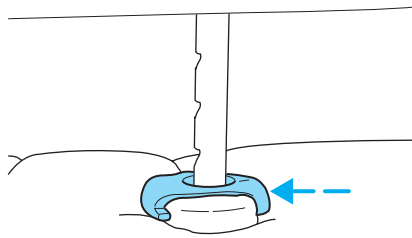

### Folding down rear seats

1. Raise the rear seat head restraint and remove.

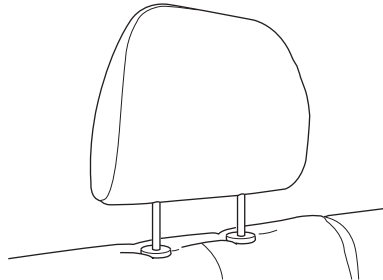

2. Place the head restraint under the front seat for storage.

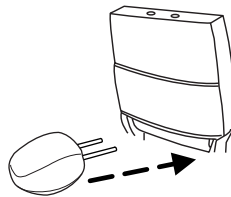

## Seating and Safety Restraints

3. Pull the seat release control.

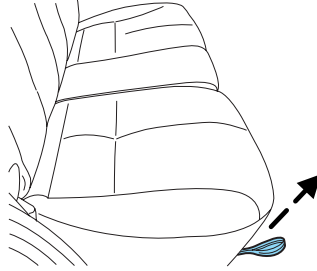

**Note:** Make sure the floor is clear of all objects before folding the seat.

4. Flip seat forward.

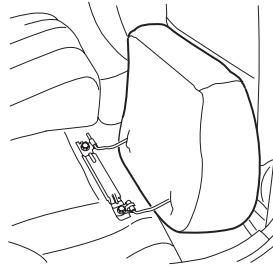

Attach the safety belt web snap button to the quarter trim panel snap button. This will ensure that safety belt does not get caught by staying out of the seat back folding path.

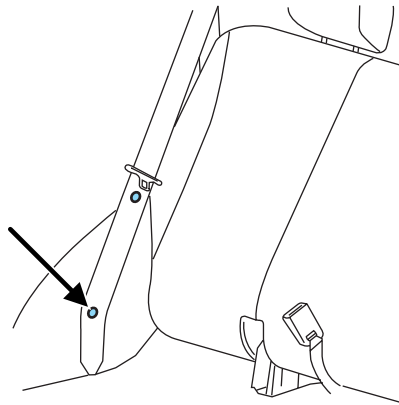

## Seating and Safety Restraints

5. To release seatback, pull the seatback release lever (on top of seat) toward the front seat. This is common for both 60% and 40% seatbacks.

**Note:** When the seatback release lever is pulled, slowly lower seatback to the flat position.

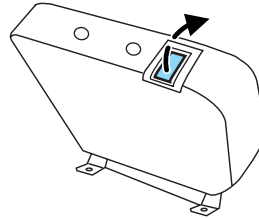

6. Rotate seatback down into load floor position.

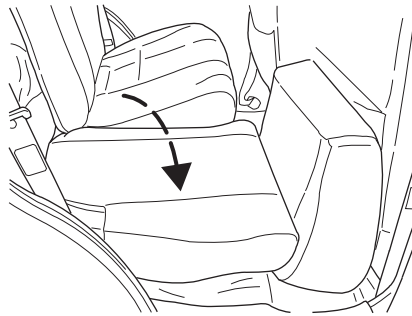

### ***Returning the rear seats to upright position***

1. Pull seatback up and into upright position making sure seatback locks into place and the red seat unlatched indicator on release paddle is not visible.

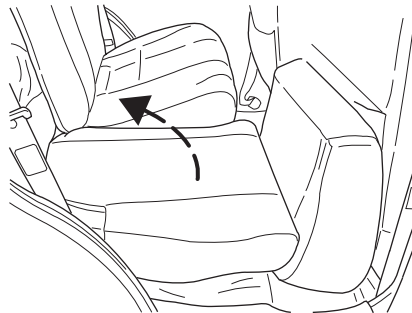

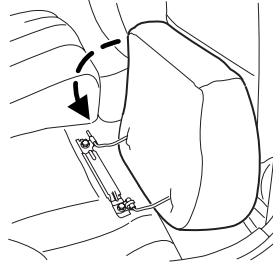

## Seating and Safety Restraints

2. Rotate seat cushion down into the seating position making sure that the seat cushion is locked into place and that the safety belt buckles are exposed.



 Make sure safety belt buckle heads are through elastic holders on seat backs. Safety belt buckles may break if they are trapped underneath the seatback as the seatback is rotated down.

 Before returning the seatback to its original position, make sure that cargo or any objects are not trapped behind the seatback. After returning the seatback to its original position, reinstall the head restraints, and pull on the seatback to ensure that it has fully latched. An unlatched seat may become dangerous in the event of a sudden stop or collision.

 Remove the head restraint stored under the front set and return it to the original position on the seatback. Failure to do so could result in personal injury.

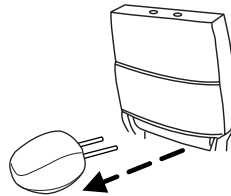

3. Unsnap the safety belt webbing from the quarter trim panel.



## Seating and Safety Restraints

### **To remove the rear cushion**

1. Lift the yellow tab to release the hinges.
2. Pull the cushion to the outboard side of the vehicle.

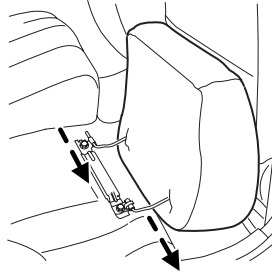

### **To install the rear cushion**

1. Push the cushion to the inboard side of the vehicle.
2. Make sure that the hinges are locked into place.

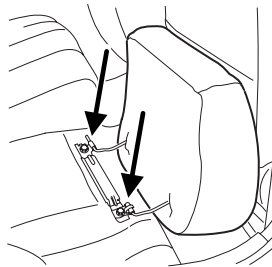

## SAFETY RESTRAINTS

### **Personal Safety System™**

The Personal Safety System™ provides an improved overall level of frontal crash protection to front seat occupants and is designed to help further reduce the risk of airbag-related injuries. The system is able to analyze different occupant conditions and crash severity before activating the appropriate safety devices to help better protect a range of occupants in a variety of frontal crash situations.

Your vehicle's Personal Safety System™ consists of:

- Driver and passenger dual-stage airbag supplemental restraints
- Front safety belts with pretensioners, energy management retractors, and safety belt usage sensors
- Front passenger sensing system
- “Passenger airbag off” or “pass airbag off” indicator lamp

## Seating and Safety Restraints

- Front crash severity sensor
- Restraints Control Module (RCM) with impact and safing sensors
- Driver's seat position sensor
- Restraint system warning light and back-up tone
- The electrical wiring for the airbags, crash sensor(s), safety belt pretensioners, front safety belt usage sensors, driver seat position sensor, front passenger sensing system, and indicator lights

### **How does the Personal Safety System™ work?**

The Personal Safety System™ can adapt the deployment strategy of your vehicle's safety devices according to crash severity and occupant conditions. A collection of crash and occupant sensors provides information to the Restraints control module (RCM). During a crash, the RCM activates the safety belt pretensioners and/or both stages of the dual-stage airbag supplemental restraints based on crash severity and occupant conditions.

The fact that the pretensioners or airbags did not activate for both front seat occupants in a collision does not mean that something is wrong with the system. Rather, it means the Personal Safety System™ determined the accident conditions (crash severity, belt usage, etc.) were not appropriate to activate these safety devices. Front airbags are designed to activate only in frontal and near-frontal collisions, not rollovers, side-impacts, or rear-impacts unless the collision causes sufficient longitudinal deceleration.

The driver's side only is equipped with dual pretensioners.

### **Dual-stage airbag supplemental restraints**

The dual-stage airbag offers the capability to tailor the level of airbag inflation energy. A lower, less forceful energy level is provided for more common, moderate-severity impacts. A higher energy level is used for the most severe impacts. Refer to *Airbag supplemental restraints* section in this chapter.

### **Front crash severity sensor**

The front crash severity sensor enhances the ability to detect the severity of an impact. Positioned up front, it provides valuable information early in the crash event on the severity of the impact. This allows your Safety System to distinguish between different levels of crash severity and modify the deployment strategy of the dual-stage airbag and safety belt pretensioners.

130

*2007 Escape Hybrid (ehv)  
Owners Guide (post-2002-fmt)  
USA (fus)*

## Seating and Safety Restraints

The driver's side only is equipped with dual pretensioners.

### **Driver's seat position sensor**

The driver's seat position sensor allows your Safety System to tailor the deployment level of the driver airbag based on seat position. The system is designed to help protect smaller drivers sitting close to the driver airbag by providing a lower airbag output level.

### **Front passenger sensing system**

For airbags to do their job they must inflate with great force, and this force can pose a potentially deadly risk to occupants that are very close to the airbag when it begins to inflate. For some occupants, like infants in rear-facing child seats, this occurs because they are initially sitting very close to the airbag. For other occupants, this occurs when the occupant is not properly restrained by safety belts or child safety seats and they move forward during pre-crash braking. The most effective way to reduce the risk of unnecessary injuries is to make sure all occupants are properly restrained. Accident statistics suggest that children are much safer when properly restrained in the rear seating positions than in the front.



Airbags can kill or injure a child in a child seat. **NEVER** place a rear-facing child seat in front of an active airbag. If you must use a forward-facing child seat in the front seat, move the seat all the way back.



Always transport children 12 years old and under in the back seat and always properly use appropriate child restraints.

The front passenger sensing system can automatically turn off the passenger front airbag. The system is designed to help protect small (child size) occupants from airbag deployments when they are improperly seated or restrained in the front passenger seat contrary to proper child-seating or restraint usage recommendations. Even with this technology, parents are **STRONGLY** encouraged to always properly restrain children in the rear seat. The sensor also turns off the passenger front airbag and seat-mounted side airbag (if equipped) when the passenger seat is empty to prevent unnecessary replacement of airbag(s) after a collision.

When the front passenger seat is occupied and the sensing system has turned off the passenger's frontal airbag, the "pass airbag off" indicator

## Seating and Safety Restraints

will light and stay lit to remind you that the front passenger frontal airbag is off. See *Front passenger sensing system* in the airbags section of this chapter.

### **Front safety belt usage sensors**

The front safety belt usage sensors detect whether or not the driver and front outboard passenger safety belts are fastened. This information allows your Safety System to tailor the airbag deployment and safety belt pretensioner activation depending upon safety belt usage. Refer to *Safety belt* section in this chapter.

### **Front safety belt pretensioners**

The safety belt pretensioners at the front outboard seating positions are designed to tighten the safety belts firmly against the occupant's body during frontal collisions, and in side collisions and rollovers when the vehicle is equipped with the Safety Canopy<sup>™</sup> system. This helps increase the effectiveness of the safety belts. In frontal collisions, the safety belt pretensioners can be activated alone or, if the collision is of sufficient severity, together with the front airbags.

### **Front safety belt energy management retractors**

The front outboard safety belt energy management retractors, once initiated, allow webbing to be pulled out of the retractor in a gradual and controlled manner in response to the occupant's forward momentum. This helps reduce the risk of force-related injuries to the occupant's chest by limiting the load on the occupant. Refer to *Energy management feature* section in this chapter.

The driver's side only is equipped with dual pretensioners.

### **Determining if the Personal Safety System is operational**

The Safety System uses a warning light in the instrument cluster or a back-up tone to indicate the condition of the system. Refer to the *Warning lights and chimes* section in the *Instrument Cluster* chapter. Routine maintenance of the Safety System is not required.

The Restraints control module (RCM) monitors its own internal circuits and the circuits for the airbag supplemental restraints, crash sensor(s), safety belt pretensioners, front safety belt buckle sensors, driver seat position sensor, and front passenger sensing system. In addition, the RCM also monitors the restraints warning light in the instrument cluster. A difficulty with the system is indicated by one or more of the following.

- The warning light will either flash or stay lit.
- The warning light will not illuminate immediately after ignition is turned on.

## Seating and Safety Restraints

- A series of five beeps will be heard. The tone pattern will repeat periodically until the problem and warning light are repaired.

If any of these things happen, even intermittently, have the Safety System serviced at an authorized dealer immediately. Unless serviced, the system may not function properly in the event of a collision.

### Safety restraints precautions



Always drive and ride with your seatback upright and the lap belt snug and low across the hips.



To reduce the risk of injury, make sure children sit where they can be properly restrained.



Never let a passenger hold a child on his or her lap while the vehicle is moving. The passenger cannot protect the child from injury in a collision.



All occupants of the vehicle, including the driver, should always properly wear their safety belts, even when an airbag supplemental restraint system (SRS) is provided.



It is extremely dangerous to ride in a cargo area, inside or outside of a vehicle. In a collision, people riding in these areas are more likely to be seriously injured or killed. Do not allow people to ride in any area of your vehicle that is not equipped with seats and safety belts. Be sure everyone in your vehicle is in a seat and using a safety belt properly.



In a rollover crash, an unbelted person is significantly more likely to die than a person wearing a safety belt.



Each seating position in your vehicle has a specific safety belt assembly which is made up of one buckle and one tongue that are designed to be used as a pair. 1) Use the shoulder belt on the outside shoulder only. Never wear the shoulder belt under the arm. 2) Never swing the safety belt around your neck over the inside shoulder. 3) Never use a single belt for more than one person.

## Seating and Safety Restraints



Always transport children 12 years old and under in the back seat and always properly use appropriate child restraints.



Safety belts and seats can become hot in a vehicle that has been closed up in sunny weather; they could burn a small child. Check seat covers and buckles before you place a child anywhere near them.

### Combination lap and shoulder belts

1. Insert the belt tongue into the proper buckle (the buckle closest to the direction the tongue is coming from) until you hear a snap and feel it latch. Make sure the tongue is securely fastened in the buckle.

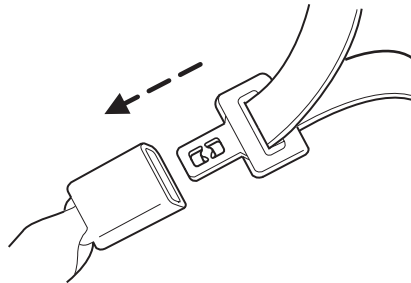

2. To unfasten, push the release button and remove the tongue from the buckle.

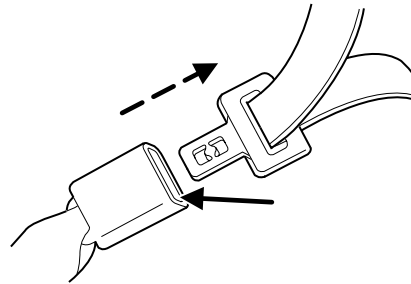

### Energy Management Feature

- This vehicle has a safety belt system with an energy management feature at the front outboard seating positions to help further reduce the risk of injury in the event of a head-on collision.
- The front outboard safety belt system has a retractor assembly that is designed to extend the safety belt webbing in a controlled manner. This helps reduce the belt force acting on the user's chest.

All safety belts in the vehicle are combination lap and shoulder belts. The passenger safety belts have two types of locking modes described below:

## Seating and Safety Restraints

### Vehicle sensitive mode

This is the normal retractor mode, which allows free shoulder belt length adjustment to your movements and locking in response to vehicle movement. For example, if the driver brakes suddenly or turns a corner sharply, or the vehicle receives an impact of approximately 5 mph (8 km/h) or more, the combination safety belts will lock to help reduce forward movement of the driver and passengers.

### Automatic locking mode

#### **When to use the automatic locking mode**

In this mode, the shoulder belt is automatically pre-locked. The belt will still retract to remove any slack in the shoulder belt. The automatic locking mode is not available on the driver safety belt.

This mode should be used **any time** a child safety seat, except a booster, is installed in passenger front or rear seating positions. Children 12 years old and under should be properly restrained in the rear seat whenever possible. Refer to *Safety restraints for children* or *Safety seats for children* later in this chapter.

#### **How to use the automatic locking mode**

- Buckle the combination lap and shoulder belt.

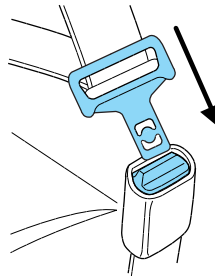

## Seating and Safety Restraints

- Grasp the shoulder portion and pull downward until the entire belt is pulled out.



- Allow the belt to retract. As the belt retracts, you will hear a clicking sound. This indicates the safety belt is now in the automatic locking mode.

### **How to disengage the automatic locking mode**

Disconnect the combination lap/shoulder belt and allow it to retract completely to disengage the automatic locking mode and activate the vehicle sensitive (emergency) locking mode.

 After any vehicle collision, the safety belt systems at all seating positions (except the driver position, which doesn't have this feature) must be checked by an authorized dealer to verify that the automatic locking retractor feature for child seats is still functioning properly. In addition, all safety belts should be checked for proper function.

 BELT AND RETRACTOR ASSEMBLY MUST BE REPLACED if the safety belt assembly "automatic locking retractor" feature or any other safety belt function is not operating properly when checked by an authorized dealer. Failure to replace the Belt and Retractor assembly could increase the risk of injury in collisions.



## Seating and Safety Restraints

### Safety belt height adjustment

Your vehicle has safety belt height adjustments at the front outboard seating positions. Adjust the height of the shoulder belt so the belt rests across the middle of your shoulder.

To adjust the shoulder belt height, squeeze and hold the buttons on the side and slide the height adjuster up or down. Release the buttons and pull down on the height adjuster to make sure it is locked in place.

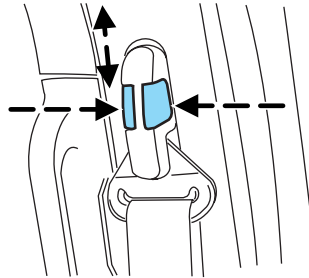

Position the safety belt height adjusters so that the belt rests across the middle of your shoulder. Failure to adjust the safety belt properly could reduce the effectiveness of the safety belt and increase the risk of injury in a collision.

### Safety belt pretensioner

Your vehicle is equipped with safety belt pretensioners at the driver and front passenger seating positions.

The safety belt pretensioners activate during frontal collisions, and in side collisions and rollovers when the vehicle is equipped with the optional Safety Canopy™ system. A safety belt pretensioner is a device which tightens the webbing of the lap and shoulder belts in such a way that they fit more snugly against the body.



The driver and front passenger safety belt system (including retractors, buckles and height adjusters) must be replaced if the vehicle is involved in a collision that results in deployment of front airbags, seat-mounted side airbags and Safety Canopy™ (if equipped), and safety belt pretensioners.



Failure to replace the safety belt assembly under the above conditions could result in severe personal injuries in the event of a collision.

## Seating and Safety Restraints

### Safety belt extension assembly

If the safety belt is too short when fully extended, there is an 8 inch (20 cm) safety belt extension assembly that can be added (part number 611C22). This assembly can be obtained from your dealer at no cost.

Use only extensions manufactured by the same supplier as the safety belt. Manufacturer identification is located at the end of the webbing on the label. Also, use the safety belt extension only if the safety belt is too short for you when fully extended.



Do not use extensions to change the fit of the shoulder belt across the torso.

### Safety belt maintenance

Inspect the safety belt systems periodically to make sure they work properly and are not damaged. Inspect the safety belts to make sure there are no nicks, tears or cuts. Replace if necessary. All safety belt assemblies, including retractors, buckles, front safety belt buckle assemblies, buckle support assemblies (slide bar-if equipped), shoulder belt height adjusters (if equipped), shoulder belt guide on seatback (if equipped), child safety seat LATCH and tether anchors, and attaching hardware, should be inspected after a collision. Ford Motor Company recommends that all safety belt assemblies in use in vehicles involved in a collision be replaced. However, if the collision was minor and an authorized dealer finds that the belts do not show damage and continue to operate properly, they do not need to be replaced. Safety belt assemblies not in use during a collision should also be inspected and replaced if either damage or improper operation is noted.



Failure to inspect and if necessary replace the safety belt assembly under the above conditions could result in severe personal injuries in the event of a collision.

For proper care of soiled safety belts, refer to *Interior* in the *Cleaning* chapter.

### Safety belt warning light and indicator chime

The safety belt warning light illuminates in the instrument cluster and a chime sounds to remind the occupants to fasten their safety belts.

138

2007 Escape Hybrid (ehv)  
Owners Guide (post-2002-fmt)  
USA (fus)

## Seating and Safety Restraints

### Conditions of operation

If...	Then...
The driver's safety belt is not buckled before the ignition switch is turned to the ON position...	The safety belt warning light illuminates 1 minute and the warning chime sounds 6 seconds.
The driver's safety belt is buckled while the indicator light is illuminated and the warning chime is sounding...	The safety belt warning light and warning chime turn off.
The driver's safety belt is buckled before the ignition switch is turned to the ON position...	The safety belt warning light and indicator chime remain off.

### BeltMinder®

The BeltMinder® feature is a supplemental warning to the safety belt warning function. This feature provides additional reminders by intermittently sounding a chime and illuminating the safety belt warning lamp in the instrument cluster when the driver's and front passenger's safety belt is unbuckled.

The BeltMinder® feature uses information from the front passenger sensing system to determine if a front seat passenger is present and therefore potentially in need of a warning. To avoid activating the BeltMinder® feature for objects placed in the front passenger seat, warnings will only be given to large front seat occupants as determined by the front passenger sensing system.

Both the driver's and passenger's safety belt usages are monitored and either may activate the BeltMinder® feature. The warnings are the same for the driver and the front passenger. If the BeltMinder® warnings have expired (warnings for approximately 5 minutes) for one occupant (driver or front passenger), the other occupant can still activate the BeltMinder® feature.

## Seating and Safety Restraints

If...	Then...
The driver's and front passenger's safety belts are buckled before the ignition switch is turned to the ON position or less than 1-2 minutes have elapsed since the ignition switch has been turned ON...	The BeltMinder® feature will not activate.
The driver's or front passenger's safety belt is not buckled when the vehicle has reached at least 5 km/h (3 mph) and 1-2 minutes have elapsed since the ignition switch has been turned to ON...	The BeltMinder® feature is activated - the safety belt warning light illuminates and the warning chime sounds for 6 seconds every 30 seconds, repeating for approximately 5 minutes or until the safety belts are buckled.
The driver's or front passenger's safety belt becomes unbuckled for approximately 1 minute while the vehicle is traveling at least 5 km/h (3 mph) and more than 1-2 minutes have elapsed since the ignition switch has been turned to ON...	The BeltMinder® feature is activated - the safety belt warning light illuminates and the warning chime sounds for 6 seconds every 30 seconds, repeating for approximately 5 minutes or until the safety belts are buckled.

The following are reasons most often given for not wearing safety belts (All statistics based on U.S. data):

Reasons given...	Consider...
"Crashes are rare events"	<b>36700 crashes occur every day.</b> The more we drive, the more we are exposed to "rare" events, even for good drivers. <i>1 in 4 of us will be seriously injured in a crash during our lifetime.</i>
"I'm not going far"	<b>3 of 4</b> fatal crashes occur within <b>25</b> miles of home.

## Seating and Safety Restraints

Reasons given...	Consider...
"Belts are uncomfortable"	Your Ford safety belts are designed to enhance comfort. If you are uncomfortable - try different positions for the safety belt upper anchorage and seatback which should be as upright as possible; this can improve comfort.
"I was in a hurry"	<b>Prime time for an accident.</b> BeltMinder® reminds us to take a few seconds to buckle up.
"Safety belts don't work"	<b>Safety belts</b> , when used properly, <b>reduce risk of death</b> to front seat occupants by <b>45% in cars</b> , and by <b>60% in light trucks</b> .
"Traffic is light"	<b>Nearly 1 of 2 deaths occur in single-vehicle crashes</b> , many when no other vehicles are around.
"Belts wrinkle my clothes"	Possibly, but a serious crash can do much more than wrinkle your clothes, particularly if you are unbelted.
"The people I'm with don't wear belts"	Set the example, teen deaths occur 4 times more often in vehicles with TWO or MORE people. Children and younger brothers/sisters imitate behavior they see.
"I have an airbag"	Airbags offer greater protection when used with safety belts. Frontal airbags are not designed to inflate in rear and side crashes or rollovers.
"I'd rather be thrown clear"	Not a good idea. <b>People</b> who are <b>ejected are 40 times more likely to DIE</b> . Safety belts help prevent ejection, WE CAN'T "PICK OUR CRASH".



Do not sit on top of a buckled safety belt or insert a latchplate into the buckle to avoid the BeltMinder® chime. To do so may adversely affect the performance of the vehicle's air bag system

### **One time disable**

If at any time the driver/front passenger quickly buckles then unbuckles the safety belt for that seating position, the BeltMinder® is disabled for the current ignition cycle. The BeltMinder® feature will enable during the same ignition cycle if the occupant buckles and remains buckled for approximately 30 seconds. Confirmation is not given for the one time disable.

## Seating and Safety Restraints

### **Deactivating/activating the BeltMinder® feature**

**The driver and front passenger BeltMinder® are deactivated/activated independently. When deactivating/activating one seating position, do not buckle the other position as this will terminate the process.**

*Read Steps 1 - 4 thoroughly before proceeding with the deactivation/activation programming procedure.*

The driver and front passenger BeltMinder® features can be deactivated/activated by performing the following procedure:

Before following the procedure, make sure that:

- The parking brake is set
- The gearshift is in P (Park)
- The ignition switch is in the OFF position
- The driver and front passenger safety belts are unbuckled



While the design allows you to deactivate your BeltMinder®, this system is designed to improve your chances of being safely belted and surviving an accident. We recommend you leave the BeltMinder® system activated for yourself and others who may use the vehicle. To reduce the risk of injury, do not deactivate/activate the BeltMinder® feature while driving the vehicle.

1. Turn the ignition switch to the RUN (or ON) position. (DO NOT START THE ENGINE)
2. Wait until the safety belt warning light turns off. (Approximately 1 minute)
  - Step 3 must be completed within 50 seconds after the safety belt warning light turns off.
3. For the seating position being disabled, at a moderate speed, buckle then unbuckle the safety belt 9 times, ending in the unbuckled state. (Step 3 must be completed within 50 seconds after the safety belt warning light turns off.)
  - After Step 3, the restraint system warning light (airbag light) will be turned on for three seconds.
4. Within 10 seconds of the light turning on, at a moderate speed, buckle then unbuckle the safety belt.
  - This will disable the BeltMinder® feature for that seating position if it is currently enabled. As confirmation, the restraint system warning light will flash 4 times per second for 3 seconds.

142

**2007 Escape Hybrid (ehv)**  
**Owners Guide (post-2002-fmt)**  
**USA (fus)**

## Seating and Safety Restraints

- This will enable the BeltMinder® feature for that seating position if it is currently disabled. As confirmation, the restraint system warning light will flash 4 times per second for 3 seconds, followed by 3 seconds with the light off, then followed by the restraint system warning light flashing 4 times per second for 3 seconds again.
- After receiving confirmation, the deactivation/activation procedure is complete.

### AIRBAG SUPPLEMENTAL RESTRAINT SYSTEM (SRS)

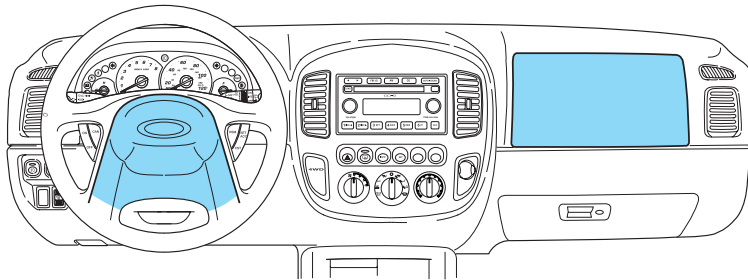

#### Important SRS precautions

The SRS is designed to work with the safety belt to help protect the driver and right front passenger from certain upper body injuries. Airbags DO NOT inflate slowly; there is a risk of injury from a deploying airbag.

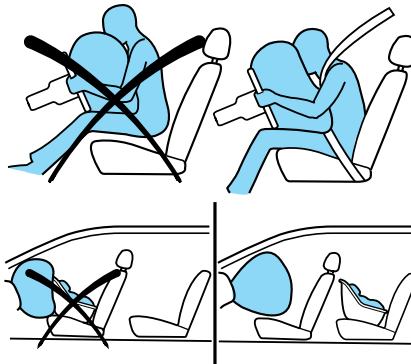

All occupants of the vehicle, including the driver, should always properly wear their safety belts, even when an air bag supplemental restraint system (SRS) is provided.

## Seating and Safety Restraints



Always transport children 12 years old and under in the back seat and always properly use appropriate child restraints.



The National Highway Traffic Safety Administration (NHTSA) recommends a minimum distance of at least 10 inches (25 cm) between an occupant's chest and the driver airbag module.



Never place your arm over the airbag module as a deploying airbag can result in serious arm fractures or other injuries.

To properly position yourself away from the airbag:

- Move your seat to the rear as far as you can while still reaching the pedals comfortably.
- Recline the seat slightly one or two degrees from the upright position.



Do not put anything on or over the airbag module. Placing objects on or over the airbag inflation area may cause those objects to be propelled by the airbag into your face and torso causing serious injury.



Do not attempt to service, repair, or modify the airbag supplemental restraint systems or its fuses. See your authorized dealer.



Modifications to the front end of the vehicle, including frame, bumper, front end body structure, tow hooks and B-pillar surrounding parts may affect the performance of the airbag sensors increasing the risk of injury. Do not modify the front end of the vehicle.



Additional equipment may affect the performance of the airbag sensors increasing the risk of injury. Please refer to the *Body Builders Layout Book* for instructions about the appropriate installation of additional equipment.



## Seating and Safety Restraints

### Children and airbags

Children must always be properly restrained. Accident statistics suggest that children are safer when properly restrained in the rear seating positions than in the front seating position. Failure to follow these instructions may increase the risk of injury in a collision.

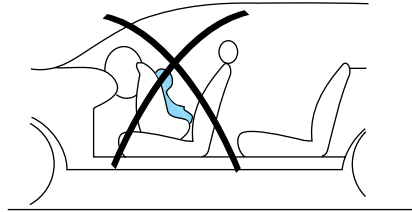

Airbags can kill or injure a child in a child seat.

**NEVER** place a rear-facing child seat in front of an active airbag. If you must use a forward-facing child seat in the front seat, move the seat all the way back.

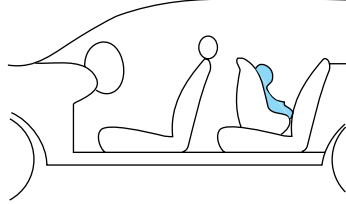

### How does the airbag supplemental restraint system work?

The airbag SRS is designed to activate when the vehicle sustains a longitudinal deceleration sufficient to cause the airbag sensors to close an electrical circuit that initiates airbag inflation. The fact that the airbags did not inflate in a collision does not mean that something is wrong with the system. Rather, it means the forces were not sufficient enough to cause activation. Front airbags are designed to inflate in frontal and near-frontal collisions, not rollover, side-impact, or rear-impacts unless the collision causes sufficient longitudinal deceleration.

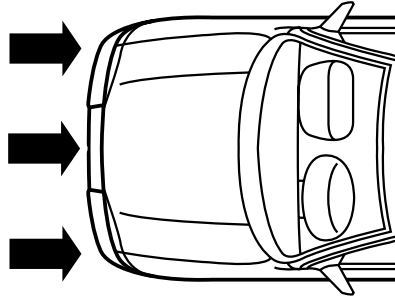

## Seating and Safety Restraints

The airbags inflate and deflate rapidly upon activation. After airbag deployment, it is normal to notice a smoke-like, powdery residue or smell the burnt propellant. This may consist of cornstarch, talcum powder or sodium compounds which may irritate the skin and eyes, but none of the residue is toxic.

While the SRS is designed to help reduce serious injuries, contact with a deploying airbag may also cause abrasions, swelling or temporary hearing loss. Because airbags must inflate rapidly and with considerable force, there is the risk of death or serious injuries such as fractures, facial and eye injuries or internal injuries, particularly to occupants who are not properly restrained or are otherwise out of position at the time of airbag deployment. It is extremely important that occupants be properly restrained as far away from the airbag module as possible while maintaining vehicle control.



The SRS consists of:

- driver and passenger airbag modules (which include the inflators and airbags).
- seat-mounted side airbags (if equipped). Refer to *Seat-mounted side airbag system* later in this chapter
- Safety Canopy<sup>™</sup> system (if equipped). Refer to *Safety Canopy<sup>™</sup> system* later in this chapter.
- one or more impact and safing sensors.
- Safety belt pretensioners
- a readiness light and tone.
- diagnostic module.
- and the electrical wiring which connects the components.
- Front passenger sensing system. Refer to *Front passenger sensing system.* later in this chapter.
- “Passenger airbag off” or “pass airbag off” indicator lamp. Refer to *Front passenger sensing system* later in this chapter.

The RCM (restraints control module) monitors its own internal circuits and the supplemental airbag electrical system wiring (including the

## Seating and Safety Restraints

impact sensors, the system wiring, the airbag system readiness light, the airbag back up power and the airbag ignitors).



Several air bag system components get hot after inflation. Do not touch them after inflation.



If the airbag has deployed, **the airbag will not function again and must be replaced immediately.** If the airbag is not replaced, the unrepaired area will increase the risk of injury in a collision.

### Front passenger sensing system

The front passenger sensing system is designed to meet the regulatory requirements of Federal Motor Vehicle Safety Standard (FMVSS) 208 and is designed to disable (will not inflate) the front passenger's frontal airbag under certain conditions.

The front passenger sensing system works with sensors that are part of the front passenger's seat and safety belt. The sensors are designed to detect the presence of a properly seated occupant and determine if the front passenger's frontal airbag should be enabled (may inflate) or disabled (will not inflate).

The front passenger sensing system will disable (will not inflate) the front passenger's frontal airbag if:

- the front passenger seat is unoccupied, or has small/medium objects in the front seat,
- the system determines that an infant is present in a rear-facing infant seat that is installed according to the manufacturer's instructions,
- the system determines that a small child is present in a forward-facing child restraint that is installed according to the manufacturer's instructions,
- the system determines that a small child is present in a booster seat,
- a front passenger takes his/her weight off of the seat for a period of time,

For side airbag equipped vehicles, the front passenger sensing system will turn off the passenger seat side airbag if:

- the seat is empty and safety belt is unbuckled.

## Seating and Safety Restraints

The front passenger sensing system uses a "passenger airbag off" or "pass airbag off" indicator which will illuminate and stay lit to remind you that the front passenger frontal airbag is off. The indicator lamp is located in the center stack of the instrument panel just below the radio.



**Note:** The indicator lamp will illuminate for a short period of time when the ignition is turned to the ON position to confirm it is functional.

When the front passenger seat is not occupied (empty seat) or in the event that the front passenger frontal airbag is enabled (may inflate), the indicator lamp will be unlit.

The front passenger sensing system is designed to disable (will not inflate) the front passenger's frontal airbag when a rear facing infant seat, a forward-facing child restraint, or a booster seat is detected.

- When the front passenger sensing system disables (will not inflate) the front passenger frontal airbag, the indicator lamp will illuminate and stay lit to remind you that the front passenger frontal airbag is disabled.
- If the child restraint has been installed and the indicator lamp is not lit, then turn the vehicle off, remove the child restraint from the vehicle and reinstall the restraint following the child restraint manufacturer's instructions.

The front passenger sensing system is designed to enable (may inflate) the front passenger's frontal airbag anytime the system senses that a person of adult size is sitting properly in the front passenger seat.

- When the front passenger sensing system enables the front passenger frontal airbag (may inflate), the indicator will be unlit and stay unlit.

If a person of adult size is sitting in the front passenger's seat, but the "passenger airbag off" or "pass airbag off" indicator lamp is lit, it is possible that the person isn't sitting properly in the seat. If this happens:

- Turn the vehicle off and ask the person to place the seatback in the full upright position.
- Have the person sit upright in the seat, centered on the seat cushion, with the person's legs comfortably extended.
- Restart the vehicle and have the person remain in this position for about two minutes. This will allow the system to detect that person and enable the passenger's frontal airbag.

148

*2007 Escape Hybrid (ehv)  
Owners Guide (post-2002-fmt)  
USA (fus)*

## Seating and Safety Restraints

- If the indicator lamp remains lit even after this, the person should be advised to ride in the rear seat.

Occupant	Pass Airbag Off Indicator Lamp	Passenger Airbag
Empty seat	Unlit	Disabled
Small child in child safety seat or booster	Lit	Disabled
Small child with safety belt buckled or unbuckled	Lit	Disabled
Adult	Unlit	Enabled



Even with Advanced Restraints Systems, children 12 and under should be properly restrained in the back seat.

After all occupants have adjusted their seats and put on safety belts, it's very important that they continue to sit properly. A properly seated occupant sits upright, leaning against the seat back, and centered on the seat cushion, with their feet comfortably extended on the floor. Sitting improperly can increase the chance of injury in a crash event. For example, if an occupant slouches, lies down, turns sideways, sits forward, leans forward or sideways, or puts one or both feet up, the chance of injury during a crash is greatly increased.



Sitting improperly out of position or with the seat back reclined too far can take off weight from the seat cushion and affect the decision of the front passenger sensing system, resulting in serious injury or death in a crash.

Always sit upright against your seatback, with your feet on the floor.

The front passenger sensing system may detect small or medium objects placed on the seat cushion. For most objects that are in the front passenger seat, the passenger airbag will be disabled. Even though the passenger airbag is disabled, the "pass airbag off" lamp may or may not be illuminated according to the table below.

## Seating and Safety Restraints

Objects	Pass Airbag Off Indicator Lamp	Passenger Airbag
Small (i.e. 3 ring binder, small purse, bottled water)	Unlit	Disabled
Medium (i.e. heavy briefcase, fully packed luggage)	Lit	Disabled
Empty seat, or small to medium object with safety belt buckled	Lit	Disabled

If you think that the status of the passenger airbag off indicator lamp is incorrect, check for the following:

- Objects lodged underneath the seat
- Objects between the seat cushion and the center console (if equipped)
- Objects hanging off the seat back
- Objects stowed in the seatback map pocket (if equipped)
- Objects placed on the occupant's lap
- Cargo interference with the seat
- Other passengers pushing or pulling on the seat
- Rear passenger feet and knees resting or pushing on the seat

The conditions listed above may cause the weight of a properly seated occupant to be incorrectly interpreted by the front passenger sensing system. The person in the front passenger seat may appear heavier or lighter due to the conditions described in the list above.



To reduce the risk of possible serious injury:

Do not stow objects in seat back map pocket (if equipped) or hang objects off seat back if a child is in the front passenger seat. Do not place objects underneath the front passenger seat or between the seat and the center console (if equipped). Check the "passenger airbag off" or "pass airbag off" indicator lamp for proper airbag Status. Failure to follow these instructions may interfere with the front passenger seat sensing system.

## Seating and Safety Restraints

In case there is a problem with the front passenger sensing system, the airbag readiness lamp in the instrument cluster will stay lit.



### **If the airbag readiness lamp is lit, do the following:**

The driver and/or adult passengers should check for any objects that may be lodged underneath the front passenger seat or cargo interfering with the seat.

If objects are lodged and/or cargo is interfering with the seat; please take the following steps to remove the obstruction:

- Pull the vehicle over.
- Turn the vehicle off.
- Driver and/or adult passengers should check for any objects lodged underneath the front passenger seat or cargo interfering with the seat.
- Remove the obstruction(s) (if found).
- Restart the vehicle.
- Wait at least 2 minutes and verify that the airbag readiness lamp is no longer illuminated
- If the airbag readiness lamp remains illuminated, this may or may/not be a problem due to the front passenger sensing system.

DO NOT attempt to repair or service the system; take your vehicle immediately to an authorized dealer.

If it is necessary to modify an advanced front airbag system to accommodate a person with disabilities, contact the Ford Customer Relationship Center at the phone number shown in the *Customer Assistance* chapter of this *Owner's Guide*.



Any alteration/modification to the front passenger seat may affect the performance of the front passenger sensing system.

### **Determining if the system is operational**

The SRS uses a readiness light in the instrument cluster or a tone to indicate the status of the system. Refer to *Airbag readiness* section in the *Instrument Cluster* chapter. Routine maintenance of the airbag is not required.

## Seating and Safety Restraints

A difficulty with the system is indicated by one or more of the following:

- The readiness light will either flash or stay lit.
- The readiness light will not illuminate immediately after ignition is turned on.
- A series of five beeps will be heard. The tone pattern will repeat periodically until the problem and/or light are repaired.



If any of these things happen, even intermittently, have the SRS serviced at an authorized dealer immediately. Unless serviced, the system may not function properly in the event of a collision.

### Seat-mounted side airbag system (if equipped)



Do not place objects or mount equipment on or near the airbag cover on the side of the seatbacks of the front seats or in front seat areas that may come into contact with a deploying airbag. Failure to follow these instructions may increase the risk of personal injury in the event of a collision.



Do not use accessory seat covers. The use of accessory seat covers may prevent the deployment of the side airbags and increase the risk of injury in an accident.



Do not lean your head on the door. The side airbag could injure you as it deploys from the side of the seatback.



Do not attempt to service, repair, or modify the airbag SRS, its fuses or the seat cover on a seat containing an airbag. See an authorized dealer.



All occupants of the vehicle should always wear their safety belts even when an airbag SRS is provided.



## Seating and Safety Restraints

### **How does the side airbag system work?**

The design and development of the side airbag system included recommended testing procedures that were developed by a group of automotive safety experts known as the Side Airbag Technical Working Group. These recommended testing procedures help reduce the risk of injuries related to the deployment of side airbags.

The side airbag system consists of the following:

- An inflatable nylon bag (airbag) with a gas generator concealed behind the outboard bolster of the driver and front passenger seatbacks.
- A special seat cover designed to allow airbag deployment.
- The same warning light, electronic control and diagnostic unit as used for the front airbags.
- Two crash sensors located on the lower portion of the b-pillar (one on each side of the vehicle).

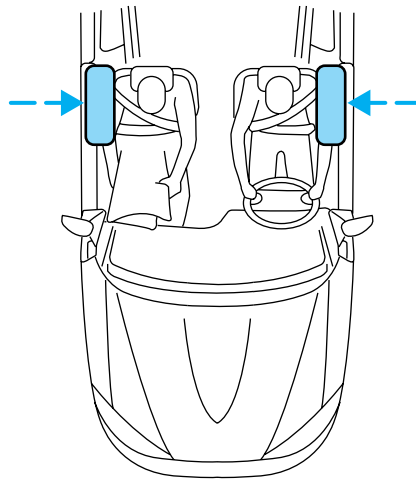

Side airbags, in combination with safety belts, can help reduce the risk of severe injuries in the event of a significant side impact collision.

The side airbags are fitted on the outboard side of the seatbacks of the front seats. In certain lateral collisions, the airbag on the side affected by the collision will be inflated. If the front passenger sensing system detects an empty seat, the front passenger seat-mounted side airbag will be deactivated. The airbag was designed to inflate between the door panel and occupant to further enhance the protection provided occupants in side impact collisions.

The airbag SRS is designed to activate when the vehicle sustains lateral deceleration sufficient to cause the sensors to close an electrical circuit that initiates airbag inflation.

The fact that the airbags did not inflate in a collision does not mean that something is wrong with the system. Rather, it means the forces were not of the type sufficient to cause activation. Side airbags are designed

## Seating and Safety Restraints

to inflate in side-impact collisions, not roll-over, rear-impact, frontal or near-frontal collisions, unless the collision causes sufficient lateral deceleration.



Several airbag system components get hot after inflation. Do not touch them after inflation.



If the side airbag has deployed, **the airbag will not function again. The side airbag system (including the seat) must be inspected and serviced by an authorized dealer.** If the airbag is not replaced, the unrepaired area will increase the risk of injury in a collision.

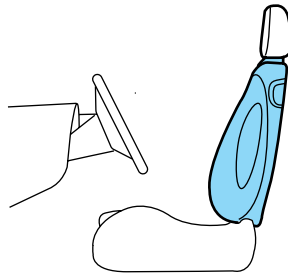

### ***Determining if the system is operational***

The SRS uses a readiness light in the instrument cluster or a tone to indicate the condition of the system. Refer to the *Airbag readiness* section in the *Instrument Cluster* chapter. Routine maintenance of the side airbag is not required.

A difficulty with the system is indicated by one or more of the following:

- The readiness light (same light as for front airbag system) will either flash or stay lit.
- The readiness light will not illuminate immediately after ignition is turned on.
- A series of five beeps will be heard. The tone pattern will repeat periodically until the problem and/or light are repaired.

If any of these things happen, even intermittently, have the SRS serviced at your authorized dealer immediately. Unless serviced, the system may not function properly in the event of a collision.

## Seating and Safety Restraints

### Safety Canopy™ system (if equipped)

 Do not place objects or mount equipment on or near the headliner at the siderail that may come into contact with a deploying Safety Canopy™. Failure to follow these instructions may increase the risk of personal injury in the event of a collision.

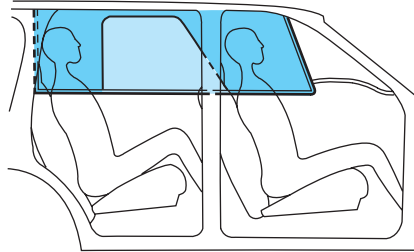

 Do not lean your head on the door. The Safety Canopy™ could injure you as it deploys from the headliner.

 Do not attempt to service, repair, or modify the Safety Canopy™ system, its fuses, the A, B, or C pillar trim, or the headliner on a vehicle containing a Safety Canopy™. See your authorized dealer.

 All occupants of the vehicle including the driver should always wear their safety belts even when an airbag SRS and Safety Canopy™ system is provided.

 To reduce risk of injury, do not obstruct or place objects in the deployment path of the inflatable Safety Canopy™.

## Seating and Safety Restraints

### How does the Safety Canopy™ system work?

The design and development of the Safety Canopy™ system included recommended testing procedures that were developed by a group of automotive safety experts known as the Side Airbag Technical Working Group. These recommended testing procedures help reduce the risk of injuries related to the deployment of side airbags (including the Safety Canopy™).

The Safety Canopy™ system consists of the following:

- An inflatable nylon curtain with a gas generator concealed behind the headliner and above the doors (one on each side of vehicle).
- A headliner designed to flex open above the side doors to allow Safety Canopy™ deployment.
- The same warning light, electronic control and diagnostic unit as used for the front airbags.
- Two crash sensors mounted at lower B-Pillar (one on each side).
- Two crash sensors located at the c-pillar behind the rear doors (one on each side).
- Rollover sensor in the restraints control module (RCM).

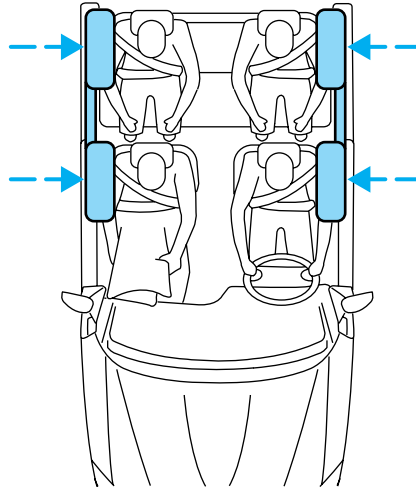

The Safety Canopy™ system, in combination with safety belts, can help reduce the risk of severe injuries in the event of a significant side impact collision or rollover event.

Children 12 years old and under should always be properly restrained in the second or third row seats. The Safety Canopy™ will not interfere with children restrained using a properly installed child or booster seat because it is designed to inflate downward from the headliner above the doors along the side window opening.

The Safety Canopy™ system is designed to active when the vehicle sustains lateral deceleration sufficient to cause the RCM to initiate Safety Canopy™ inflation or when a certain likelihood of a rollover event is detected by the rollover sensor.

## Seating and Safety Restraints

The Safety Canopy™ is mounted to roof side-rail sheet metal, behind the headliner, above the first and second row seats. The Safety Canopy™ is designed to inflate between the side window area and occupants to further enhance protection provided in side impact collisions and rollover events.

The fact that the Safety Canopy™ did not activate in a collision does not mean that something is wrong with the system. Rather, it means the forces were not of the type sufficient to cause activation. The Safety Canopy™ is designed to inflate in certain side impact collisions or rollover events, not in rear impact, frontal or near-frontal collisions, unless the collision causes sufficient lateral deceleration or rollover likelihood.



Several Safety Canopy™ system components get hot after inflation. Do not touch them after inflation.



If the Safety Canopy™ system has deployed, **the Safety Canopy™ will not function again unless replaced. The Safety Canopy™ system (including the A, B and C pillar trim) must be inspected and serviced by a authorized dealer.** If the Safety Canopy™ is not replaced, the unrepaired area will increase the risk of injury in a collision.

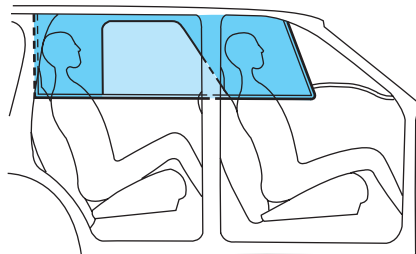

### ***Determining if the system is operational***

The SRS uses a readiness light in the instrument cluster or a tone to indicate the condition of the system. Refer to the *Airbag readiness* section in the *Instrument Cluster* chapter. Routine maintenance of the side airbag is not required.

## Seating and Safety Restraints

A difficulty with the system is indicated by one or more of the following:

- The readiness light (same light as for front airbag system) will either flash or stay lit.
- The readiness light will not illuminate immediately after ignition is turned on.
- A series of five beeps will be heard. The tone pattern will repeat periodically until the problem and/or light are repaired.

If any of these things happen, even intermittently, have the SRS serviced at your authorized dealer immediately. Unless serviced, the system may not function properly in the event of a collision.

### **Disposal of airbags and airbag equipped vehicles (including pretensioners)**

See your authorized dealer. Airbags **MUST BE** disposed of by qualified personnel.

### **SAFETY RESTRAINTS FOR CHILDREN**

See the following sections for directions on how to properly use safety restraints for children. Also see *Airbag supplemental restraint system (SRS)* in this chapter for special instructions about using airbags.

#### **Important child restraint precautions**

You are required by law to use safety restraints for children in the U.S. and Canada. If small children (generally children who are four years old or younger and who weigh 40 lb. [18 kg] or less) ride in your vehicle, you must put them in safety seats made especially for children. Many states require that children use approved booster seats until they are eight years old. Check your local and state or provincial laws for specific requirements regarding the safety of children in your vehicle. When possible, always place children under age 12 in the rear seat of your vehicle. Accident statistics suggest that children are safer when properly restrained in the rear seating positions than in the front seating position.



Never let a passenger hold a child on his or her lap while the vehicle is moving. The passenger cannot protect the child from injury in a collision.

Always follow the instructions and warnings that come with any infant or child restraint you might use.

158

*2007 Escape Hybrid (ehv)*  
*Owners Guide (post-2002-fmt)*  
*USA (fus)*

## Seating and Safety Restraints

### Children and safety belts

If the child is the proper size, restrain the child in a safety seat. Children who are too large for child safety seats (as specified by your child safety seat manufacturer) should always wear safety belts.

Follow all the important safety restraint and airbag precautions that apply to adult passengers in your vehicle.

If the shoulder belt portion of a combination lap and shoulder belt can be positioned so it does not cross or rest in front of the child's face or neck, the child should wear the lap and shoulder belt. Moving the child closer to the center of the vehicle may help provide a good shoulder belt fit.



Do not leave children, unreliable adults, or pets unattended in your vehicle.

### Child booster seats

Children outgrow a typical convertible or toddler seat when they weigh 40 lb. (18 kg) and are around 4 years of age. Although the lap/shoulder belt will provide some protection, these children are still too small for lap/shoulder belts to fit properly, which could increase the risk of serious injury in a crash.

To improve the fit of both the lap and shoulder belt on children who have outgrown child safety seats, Ford Motor Company recommends use of a belt-positioning booster.

Booster seats position a child so that safety belts fit better. They lift the child up so that the lap belt rests low across the hips and the knees bend comfortably. Booster seats may also make the shoulder belt fit better and more comfortably. Try to keep the belt near the middle of the shoulder.

### ***When children should use booster seats***

Children need to use booster seats from the time they outgrow the toddler seat until they are big enough for the vehicle seat and lap/shoulder belt to fit properly. Generally this is when they weigh about 80 lb. (36 kg) (about 8 to 12 years old).

Booster seats should be used until you can answer YES to ALL of these questions:

## Seating and Safety Restraints

- Can the child sit all the way back against the vehicle seat back with knees bent comfortably at the edge of the seat without slouching?

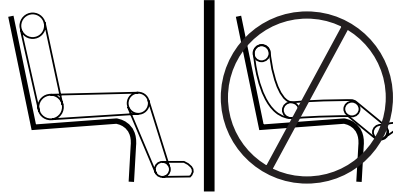

- Does the lap belt rest low across the hips?
- Is the shoulder belt centered on the shoulder and chest?
- Can the child stay seated like this for the whole trip?

### **Types of booster seats**

There are two types of belt-positioning booster seats:

- Those that are backless.

If your backless booster seat has a removable shield, remove the shield and use the lap/shoulder belt. If a seating position has a low seat back and no head restraint, a backless booster seat may place your child's head (top of ear level) above the top of the seat. In this case, move the backless booster to another seating position with a higher seat back and lap/shoulder belts.



- Those with a high back.

If, with a backless booster seat, you cannot find a seating position that adequately supports your child's head, a high back booster seat would be a better choice.



Either type can be used at any seating position equipped with lap/shoulder belts if your child is over 40 lb. (18 kg).



## Seating and Safety Restraints

Children and booster seats vary widely in size and shape. Choose a booster that keeps the lap belt low and snug across the hips, never up across the stomach, and lets you adjust the shoulder belt to cross the chest and rest snugly near the center of the shoulder. The drawings below compare the ideal fit (center) to a shoulder belt uncomfortably close to the neck and a shoulder belt that could slip off the shoulder.

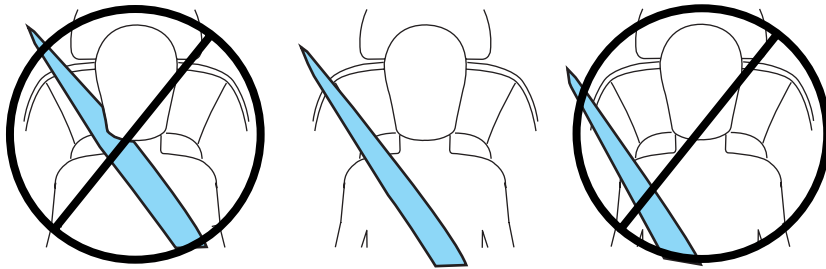

If the booster seat slides on the vehicle seat, placing a rubberized mesh sold as shelf or carpet liner under the booster seat may improve this condition.

### ***The importance of shoulder belts***

Using a booster without a shoulder belt increases the risk of a child's head hitting a hard surface in a collision. For this reason, you should never use a booster seat with a lap belt only. It is best to use a booster seat with lap/shoulder belts in the back seat- the safest place for children to ride.



Move a child to a different seating location if the shoulder belt does not stay positioned on the shoulder during use.



Follow all instructions provided by the manufacturer of the booster seat.



Never put the shoulder belt under a child's arm or behind the back because it eliminates the protection for the upper part of the body and may increase the risk of injury or death in a collision.

## Seating and Safety Restraints



Never use pillows, books, or towels to boost a child. They can slide around and increase the likelihood of injury or death in a collision.

### SAFETY SEATS FOR CHILDREN

#### Child and infant or child safety seats

Use a safety seat that is recommended for the size and weight of the child. Carefully follow all of the manufacturer's instructions with the safety seat you put in your vehicle. If you do not install and use the safety seat properly, the child may be injured in a sudden stop or collision.

When installing a child safety seat:

- Review and follow the information presented in the *airbag supplemental restraint system (SRS)* section in this chapter.
- Use the correct safety belt buckle for that seating position (the buckle closest to the direction the tongue is coming from).
- Insert the belt tongue into the proper buckle until you hear a snap and feel it latch. Make sure the tongue is securely fastened in the buckle.
- Keep the buckle release button pointing up and away from the safety seat, with the tongue between the child seat and the release button, to prevent accidental unbuckling.
- Place seat back in upright position.
- Put the safety belt in the automatic locking mode. Refer to *Automatic locking mode (passenger side front and outboard rear seating positions) (if equipped)* section in this chapter.
- LATCH lower anchors are recommended for use by children up to 48 lb. (22 kg) in a child restraint. Top tether anchors can be used for children up to 60 lb. (27 kg) in a child restraint, and to provide upper torso restraint for children up to 80 lb. (36 kg) using an upper torso harness and a belt-positioning booster.

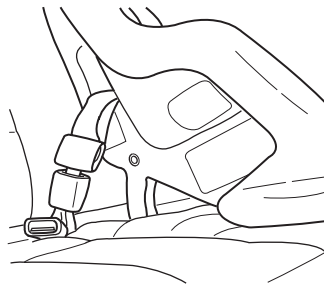

Ford recommends the use of a child safety seat having a top tether strap. Install the child safety seat in a seating position with LATCH and

## Seating and Safety Restraints

tether anchors. For more information on top tether straps and anchors, refer to *Attaching safety seats with tether straps* in this chapter. For more information of LATCH anchors refer to *Attaching safety seats with LATCH (Lower Anchors and Tethers for Children) attachments* in this chapter.

 Carefully follow all of the manufacturer's instructions included with the safety seat you put in your vehicle. If you do not install and use the safety seat properly, the child may be injured in a sudden stop or collision.

 Rear-facing child seats or infant carriers should never be placed in front of an active passenger airbag.

### Installing child safety seats with combination lap and shoulder belts

**The rear seat head restraints must be removed when using a child seat.**

 Airbags can kill or injure a child in a child seat. **NEVER** place a rear-facing child seat in front of an active air bag. If you must use a forward-facing child seat in the front seat, move the seat all the way back.

1. Position the child safety seat in a seat with a combination lap and shoulder belt.

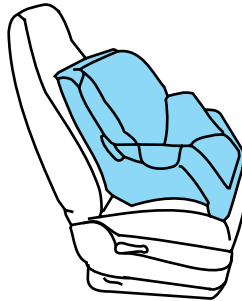

 Children 12 and under should be properly restrained in the rear seat whenever possible.

## Seating and Safety Restraints

2. Pull down on the shoulder belt and then grasp the shoulder belt and lap belt together.

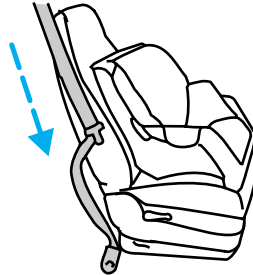

3. While holding the shoulder and lap belt portions together, route the tongue through the child seat according to the child seat manufacturer's instructions. Be sure the belt webbing is not twisted.

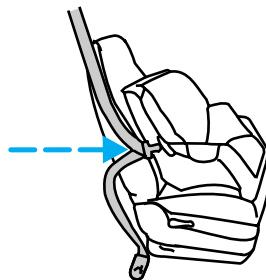

4. Insert the belt tongue into the proper buckle (the buckle closest to the direction the tongue is coming from) for that seating position until you hear a snap and feel the latch engage. Make sure the tongue is latched securely by pulling on it.

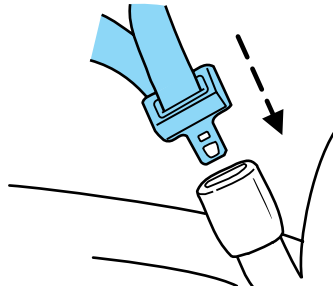

## Seating and Safety Restraints

5. To put the retractor in the automatic locking mode, grasp the shoulder portion of the belt and pull downward until all of the belt is extracted and a click is heard.

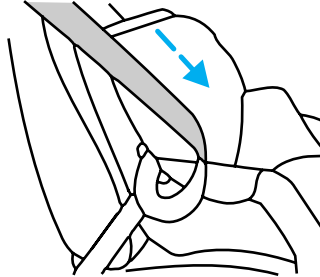

6. Allow the belt to retract. The belt will click as it retracts to indicate it is in the automatic locking mode.

7. Pull the lap belt portion across the child seat toward the buckle and pull up on the shoulder belt while pushing down with your knee on the child seat.

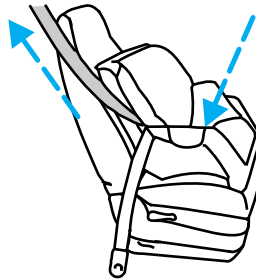

8. Allow the safety belt to retract to remove any slack in the belt.

9. Before placing the child in the seat, forcibly tilt the seat forward and back to make sure the seat is securely held in place. To check this, grab the seat at the belt path and attempt to move it side to side and forward and back. There should be no more than one inch of movement for proper installation.

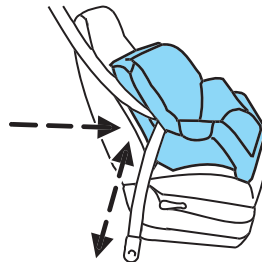

10. Try to pull the belt out of the retractor to make sure the retractor is in the automatic locking mode (you should not be able to pull more belt out). If the retractor is not locked, unbuckle the belt and repeat Steps 2 through 9.

Check to make sure the child seat is properly secured before each use.

## Seating and Safety Restraints

### Attaching child safety seats with tether straps

Most new forward-facing child safety seats include a tether strap which goes over the back of the seat and hooks to an anchoring point. Tether straps are available as an accessory for many older safety seats. Contact the manufacturer of your child seat for information about ordering a tether strap.

The rear seating positions of your vehicle are equipped with built-in tether strap anchors located behind the seats on the roof panel in the cargo area.

The tether strap anchors in your vehicle are in the following positions:

 Attach the tether strap only to the appropriate tether anchor as shown. The tether strap may not work properly if attached somewhere other than the correct tether anchor.

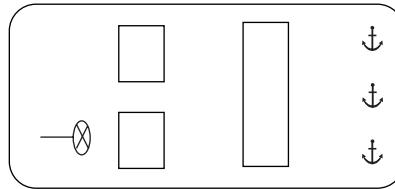

1. Position the child safety seat on the seat cushion.
2. Route the child safety seat tether strap over the back of the seat.

For vehicles with adjustable head restraints, remove the head restraint first, place under the front seat for storage, and then route the tether strap over the top of the seatback.

3. Locate the correct anchor for the selected seating position.

There are three tether anchors located on the headliner at the rear of the vehicle.

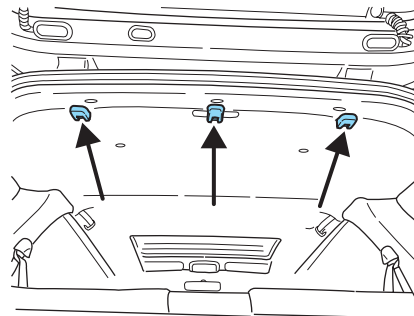

## Seating and Safety Restraints

4. Clip the tether strap to the anchor as shown.

The arrow in the above graphic points toward the front of the vehicle.

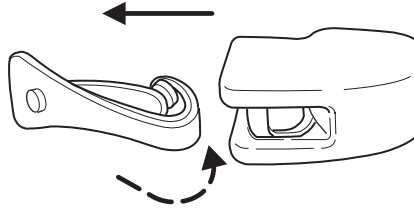

If the tether strap is clipped incorrectly, the child safety seat may not be retained properly in the event of a collision.

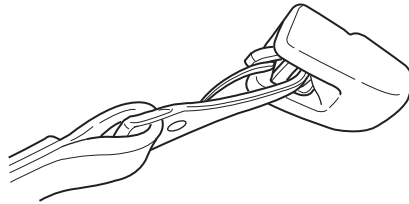

5. Install the child safety seat tightly using the LATCH anchors or safety belts. Follow the instructions in this chapter.

6. Tighten the child safety seat tether strap according to the manufacturer's instructions.



If the safety seat is not anchored properly, the risk of a child being injured in a collision greatly increases.

### Attaching safety seats with LATCH (Lower Anchors and Tethers for Children) attachments for child seat anchors

Some child safety seats have two rigid or webbing mounted attachments that connect to two anchors at certain seating positions in your vehicle. This type of child seat eliminates the need to use safety belts to attach the child seat. For forward-facing child seats, the tether strap must also be attached to the proper tether anchor. See *Attaching safety seats with tether straps* in this chapter.

## Seating and Safety Restraints

Your vehicle has LATCH anchors for child seat installation at the following locations:

The anchors on both sides of the center of the rear seat are provided primarily for child seats at the outboard seats, and are further apart than the pairs of lower anchors for child seat installation at other seats. A child seat with rigid LATCH attachments cannot be installed at the center rear seat. A child seat with LATCH attachments on belt webbing can be used at the center rear seat unless a child seat at an outboard rear seat is attached to one of these lower anchors. Install a child seat onto the lower anchors at the center rear seat **ONLY IF** the child restraint manufacturer recommends that the child seat can be installed to anchors that are spaced up to 20 in (500 mm) apart.

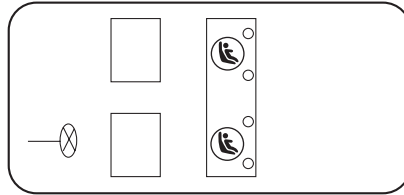

**!** Never attach two LATCH child safety seats to the same anchor. In a crash, one anchor may not be strong enough to hold two child safety seat attachments and may break, causing serious injury or death.

The lower anchors for child seat installation are located at the rear section of the second row seat between the cushion and seat back.

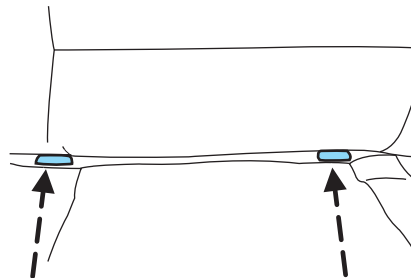

Follow the child seat manufacturer's instructions to properly install a child seat with LATCH attachments.

**!** Attach LATCH lower attachments of the child seat only to the anchors shown.

If you install a child seat with rigid LATCH attachments, do not tighten the tether strap enough to lift the child seat off the vehicle seat cushion.



## Seating and Safety Restraints

when the child is seated in it. Keep the tether strap just snug without lifting the front of the child seat. Keeping the child seat just touching the vehicle seat gives the best protection in a severe crash.

Each time you use the safety seat, check that the seat is properly attached to the lower anchors and tether anchor. Try to tilt the child seat from side to side. Also try to tug the seat forward. Check to see if the anchors hold the seat in place.





If the safety seat is not anchored properly, the risk of a child being injured in a crash greatly increases.

## Tires, Wheels and Loading

### NOTICE TO UTILITY VEHICLE AND TRUCK OWNERS

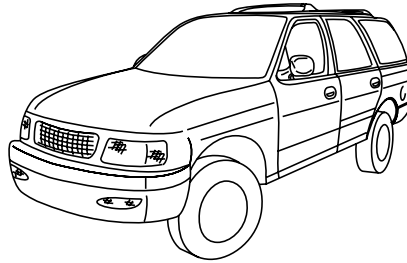
Utility vehicles and trucks handle differently than passenger cars in the various driving conditions that are encountered on streets, highways and off-road. Utility vehicles and trucks are not designed for cornering at speeds as high as passenger cars any more than low-slung sports cars are designed to perform satisfactorily under off-road conditions.



 Utility vehicles have a significantly higher rollover rate than other types of vehicles. To reduce the risk of serious injury or death from a rollover or other crash you must:

- Avoid sharp turns and abrupt maneuvers;
- Drive at safe speeds for the conditions;
- Keep tires properly inflated;
- Never overload or improperly load your vehicle; and
- Make sure every passenger is properly restrained.

 In a rollover crash, an unbelted person is significantly more likely to die than a person wearing a seat belt. All occupants must wear seat belts and children/infants must use appropriate restraints to minimize the risk of injury or ejection.

Study your “Owner’s Guide” and any supplements for specific information about equipment features, instructions for safe driving and additional precautions to reduce the risk of an accident or serious injury.

### VEHICLE CHARACTERISTICS

#### 4WD and AWD Systems

A vehicle equipped with AWD or 4WD has the ability to use all four wheels to power itself. This increases traction which may enable you to safely drive over terrain and road conditions that a conventional two-wheel drive vehicle cannot.

170

*2007 Escape Hybrid (ehv)  
Owners Guide (post-2002-fmt)  
USA (fus)*

## Tires, Wheels and Loading

Power is supplied to all four wheels through a transfer case or power transfer unit. You should become thoroughly familiar with this information before you operate your vehicle.



Do not become overconfident in the ability of 4WD and AWD vehicles. Although a 4WD or AWD vehicle may accelerate better than two-wheel drive vehicle in low traction situations, it won't stop any faster than two-wheel drive vehicles. Always drive at a safe speed.

### How your vehicle differs from other vehicles

SUV and trucks can differ from some other vehicles in a few noticeable ways. Your vehicle may be:

- Higher – to allow higher load carrying capacity and to allow it to travel over rough terrain without getting hung up or damaging underbody components.
- Shorter – to give it the capability to approach inclines and drive over the crest of a hill without getting hung up or damaging underbody components. All other things held equal, a shorter wheelbase may make your vehicle quicker to respond to steering inputs than a vehicle with a longer wheelbase.

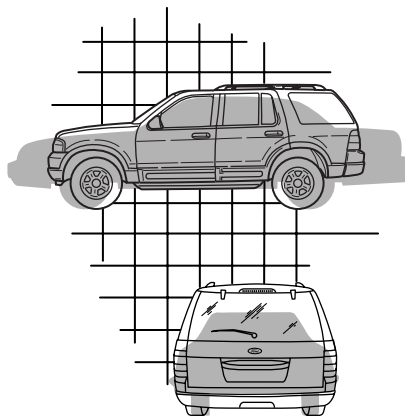

## Tires, Wheels and Loading

- Narrower — to provide greater maneuverability in tight spaces, particularly in off-road use.

As a result of the above dimensional differences, SUV's and trucks often will have a higher center of gravity and a greater difference in center of gravity between the loaded and unloaded condition.

These differences that make your vehicle so versatile also make it handle differently than an ordinary passenger car.

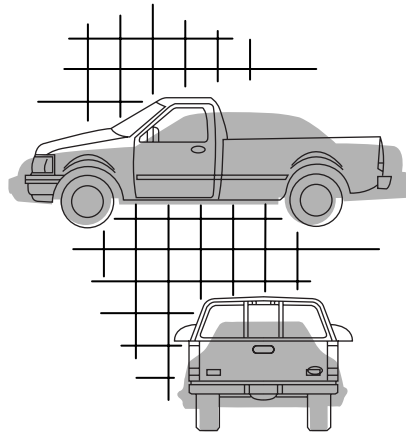

### INFORMATION ABOUT UNIFORM TIRE QUALITY GRADING

New vehicles are fitted with tires that have a rating on them called Tire Quality Grades. The Quality grades can be found where applicable on the tire sidewall between tread shoulder and maximum section width. For example:

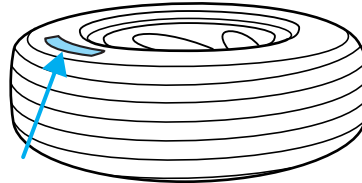

- **Treadwear 200 Traction AA Temperature A**

These Tire Quality Grades are determined by standards that the United States Department of Transportation has set.

Tire Quality Grades apply to new pneumatic tires for use on passenger cars. They do not apply to deep tread, winter-type snow tires, space-saver or temporary use spare tires, tires with nominal rim diameters of 10 to 12 inches or limited production tires as defined in Title 49 Code of Federal Regulations Part 575.104(c)(2).

**U.S. Department of Transportation-Tire quality grades:** The U.S. Department of Transportation requires Ford Motor Company to give you the following information about tire grades exactly as the government has written it.

#### **Treadwear**

The treadwear grade is a comparative rating based on the wear rate of the tire when tested under controlled conditions on a specified

## Tires, Wheels and Loading

government test course. For example, a tire graded 150 would wear one and one-half (1 1/2) times as well on the government course as a tire graded 100. The relative performance of tires depends upon the actual conditions of their use, however, and may depart significantly from the norm due to variations in driving habits, service practices, and differences in road characteristics and climate.

### Traction AA A B C

The traction grades, from highest to lowest are AA, A, B, and C. The grades represent the tire's ability to stop on wet pavement as measured under controlled conditions on specified government test surfaces of asphalt and concrete. A tire marked C may have poor traction performance.



The traction grade assigned to this tire is based on straight-ahead braking traction tests, and does not include acceleration, cornering, hydroplaning or peak traction characteristics.

### Temperature A B C

The temperature grades are A (the highest), B and C, representing the tire's resistance to the generation of heat and its ability to dissipate heat when tested under controlled conditions on a specified indoor laboratory test wheel. Sustained high temperature can cause the material of the tire to degenerate and reduce tire life, and excessive temperature can lead to sudden tire failure. The grade C corresponds to a level of performance which all passenger car tires must meet under the Federal Motor Vehicle Safety Standard No. 109. Grades B and A represent higher levels of performance on the laboratory test wheel than the minimum required by law.



The temperature grade for this tire is established for a tire that is properly inflated and not overloaded. Excessive speed, underinflation, or excessive loading, either separately or in combination, can cause heat buildup and possible tire failure.

## TIRES

Tires are designed to give many thousands of miles of service, but they must be maintained in order to get the maximum benefit from them.

### Glossary of tire terminology

- **Tire label:** A label showing the OE (Original Equipment) tire sizes, recommended inflation pressure and the maximum weight the vehicle can carry.

## Tires, Wheels and Loading

- **Tire Identification Number (TIN):** A number on the sidewall of each tire providing information about the tire brand and manufacturing plant, tire size and date of manufacture. Also referred to as DOT code.
- **Inflation pressure:** A measure of the amount of air in a tire.
- **Standard load:** A class of P-metric or Metric tires designed to carry a maximum load at 35 psi [37 psi (2.5 bar) for Metric tires]. Increasing the inflation pressure beyond this pressure will not increase the tire's load carrying capability.
- **Extra load:** A class of P-metric or Metric tires designed to carry a heavier maximum load at 41 psi [43 psi (2.9 bar) for Metric tires]. Increasing the inflation pressure beyond this pressure will not increase the tire's load carrying capability.
- **kPa:** Kilopascal, a metric unit of air pressure.
- **PSI:** Pounds per square inch, a standard unit of air pressure.
- **Cold inflation pressure:** The tire pressure when the vehicle has been stationary and out of direct sunlight for an hour or more and prior to the vehicle being driven for 1 mile (1.6 km).
- **Recommended inflation pressure:** The cold inflation pressure found on the Safety Compliance Certification Label or Tire Label located on the B-Pillar or the edge of the driver's door.
- **B-pillar:** The structural member at the side of the vehicle behind the front door.
- **Bead area of the tire:** Area of the tire next to the rim.
- **Sidewall of the tire:** Area between the bead area and the tread.
- **Tread area of the tire:** Area of the perimeter of the tire that contacts the road when mounted on the vehicle.
- **Rim:** The metal support (wheel) for a tire or a tire and tube assembly upon which the tire beads are seated.

### INFLATING YOUR TIRES

Safe operation of your vehicle requires that your tires are properly inflated. Remember that a tire can lose up to half of its air pressure without appearing flat.

Every day before you drive, check your tires. If one looks lower than the others, use a tire gauge to check pressure of all tires and adjust if required.

174

## Tires, Wheels and Loading

At least once a month and before long trips, inspect each tire and check the tire pressure with a tire gauge (including spare, if equipped). Inflate all tires to the inflation pressure recommended by Ford Motor Company.

Use a tire gauge to check the tire inflation pressure, including the spare (if equipped), at least monthly and before long trips. You are strongly urged to buy a reliable tire pressure gauge, as automatic service station gauges may be inaccurate. Ford recommends the use of a digital or dial-type tire pressure gauge rather than a stick-type tire pressure gauge.

Use the recommended cold inflation pressure for optimum tire performance and wear. Under-inflation or over-inflation may cause uneven treadwear patterns.



Under-inflation is the most common cause of tire failures and may result in severe tire cracking, tread separation or "blowout", with unexpected loss of vehicle control and increased risk of injury. Under-inflation increases sidewall flexing and rolling resistance, resulting in heat buildup and internal damage to the tire. It also may result in unnecessary tire stress, irregular wear, loss of vehicle control and accidents. A tire can lose up to half of its air pressure and not appear to be flat!

Always inflate your tires to the Ford recommended inflation pressure even if it is less than the maximum inflation pressure information found on the tire. The Ford recommended tire inflation pressure is found on the Safety Compliance Certification Label or Tire Label which is located on the B-Pillar or the edge of the driver's door. Failure to follow the tire pressure recommendations can cause uneven treadwear patterns and adversely affect the way your vehicle handles.

**Maximum Permissible Inflation Pressure** is the tire manufacturer's maximum permissible pressure and/or the pressure at which the maximum load can be carried by the tire. This pressure is normally higher than the manufacturer's recommended cold inflation pressure which can be found on the Safety Compliance Certification Label or Tire Label which is located on the B-Pillar or the edge of the driver's door. The cold inflation pressure should never be set lower than the recommended pressure on the Safety Compliance Certification Label or Tire Label.

When weather temperature changes occur, tire inflation pressures also change. A 10° F (6° C) temperature drop can cause a corresponding drop of 1 psi (7 kPa) in inflation pressure. Check your tire pressures frequently and adjust them to the proper pressure which can be found on the Safety Compliance Certification Label or Tire Label.

## Tires, Wheels and Loading

If you are checking tire pressure when the tire is hot, (i.e. driven more than 1 mile [1.6 km]), never “bleed” or reduce air pressure. The tires are hot from driving and it is normal for pressures to increase above recommended cold pressures. A hot tire at or below recommended cold inflation pressure could be significantly under-inflated.

To check the pressure in your tire(s):

1. Make sure the tires are cool, meaning they are not hot from driving even a mile.

**Note:** If you have to drive a distance to get air for your tire(s), check and record the tire pressure first and add the appropriate air pressure when you get to the pump. It is normal for tires to heat up and the air pressure inside to go up as you drive. Never “bleed” or reduce air pressure when tires are hot.

2. Remove the cap from the valve on one tire, then firmly press the tire gauge onto the valve and measure the pressure.

3. Add enough air to reach the recommended air pressure

**Note:** If you overfill the tire, release air by pushing on the metal stem in the center of the valve. Then recheck the pressure with your tire gauge.

4. Replace the valve cap.

5. Repeat this procedure for each tire, including the spare.

**Note:** Some spare tires operate at a higher inflation pressure than the other tires. For T-type/mini-spare tires (see *T-Type/Mini-Spare Tire Information* section for description): Store and maintain at 60psi (4.15 bar). For Full Size and Dissimilar spare tires (see *Dissimilar Spare Tire/Wheel Information* section for description): Store and maintain at the higher of the front and rear inflation pressure as shown on the Tire Label.

6. Visually inspect the tires to make sure there are no nails or other objects embedded that could poke a hole in the tire and cause an air leak.

7. Check the sidewalls to make sure there are no gouges, cuts or bulges.

### TIRE CARE

#### Inspecting your tires

Periodically inspect the tire treads for uneven or excessive wear and remove objects such as stones, nails or glass that may be wedged in the tread grooves. Check for holes or cuts that may permit air leakage from



## Tires, Wheels and Loading

the tire and make necessary repairs. Also inspect the tire sidewalls for cracking, cuts, bruises and other signs of damage or excessive wear. If internal damage to the tire is suspected, have the tire demounted and inspected in case it needs to be repaired or replaced. For your safety, tires that are damaged or show signs of excessive wear should not be used because they are more likely to blow out or fail.

Improper or inadequate vehicle maintenance can cause tires to wear abnormally. Inspect all your tires, including the spare, frequently, and replace them if one or more of the following conditions exist:

### Tire wear

When the tread is worn down to 1/16th of an inch (2 mm), tires must be replaced to help prevent your vehicle from skidding and hydroplaning. Built-in treadwear indicators, or “wear bars”, which look like narrow strips of smooth rubber across the tread will appear on the tire when the tread is worn down to 1/16th of an inch (2 mm). When the tire tread wears down to the same height as these “wear bars”, the tire is worn out and must be replaced.

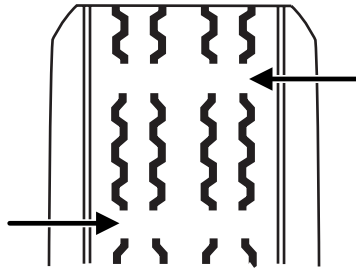

### Damage

Periodically inspect the tire treads and sidewalls for damage (such as bulges in the tread or sidewalls, cracks in the tread groove and separation in the tread or sidewall). If damage is observed or suspected have the tire inspected by a tire professional. Tires can be damaged during off-road use, so inspection after off-road use is also recommended.



### Age

Tires degrade over time, even when they are not being used. It is recommended that tires generally be replaced after 6 years of normal service. Heat caused by hot climates or frequent high loading conditions can accelerate the aging process. You should replace the spare tire when you replace the other road tires due to the aging of the spare tire.

## Tires, Wheels and Loading

### U.S. DOT Tire Identification Number (TIN)

Both U.S. and Canada Federal regulations require tire manufacturers to place standardized information on the sidewall of all tires. This information identifies and describes the fundamental characteristics of the tire and also provides a U.S. DOT Tire Identification Number for safety standard certification and in case of a recall.

This begins with the letters "DOT" and indicates that the tire meets all federal standards. The next two numbers or letters are the plant code designating where it was manufactured, the next two are the tire size code and the last four numbers represent the week and year the tire was built. For example, the numbers 317 mean the 31st week of 1997. After 2000 the numbers go to four digits. For example, 2501 means the 25th week of 2001. The numbers in between are identification codes used for traceability. This information is used to contact customers if a tire defect requires a recall.

### Tire Replacement Requirements

Your vehicle is equipped with tires designed to provide a safe ride and handling capability.



Only use replacement tires and wheels that are the same size and type (such as P-metric versus LT-metric or all-season versus all-terrain) as those originally provided by Ford. Use of any tire or wheel not recommended by Ford can affect the safety and performance of your vehicle, which could result in an increased risk of loss of vehicle control, vehicle rollover, personal injury and death. Additionally the use of non-recommended tires and wheels could cause steering, suspension, axle or transfer case/power transfer unit failure. If you have questions regarding tire replacement, see an authorized dealer.

It is recommended that the two front tires or two rear tires generally be replaced as a pair.

**Important:** Remember to replace the valve stems when the road tires are replaced on your vehicle.

**Note:** The use of a different tire can effect the fuel economy of your vehicle.

The tire pressure monitoring sensors mounted in the wheels (originally installed on your vehicle) are not designed to be used in aftermarket wheels.

178

*2007 Escape Hybrid (ehv)  
Owners Guide (post-2002-fmt)  
USA (fus)*

## Tires, Wheels and Loading

The use of wheels or tires not recommended by Ford Motor Company may affect the operation of your Tire Pressure Monitoring System.

### Safety practices

Driving habits have a great deal to do with your tire mileage and safety.

- Observe posted speed limits
- Avoid fast starts, stops and turns
- Avoid potholes and objects on the road
- Do not run over curbs or hit the tire against a curb when parking



If your vehicle is stuck in snow, mud, sand, etc., **do not** rapidly spin the tires; spinning the tires can tear the tire and cause an explosion. A tire can explode in as little as three to five seconds.



Do not spin the wheels at over 35 mph (56 km/h). The tires may fail and injure a passenger or bystander.

### Highway hazards

No matter how carefully you drive there's always the possibility that you may eventually have a flat tire on the highway. Drive slowly to the closest safe area out of traffic. This may further damage the flat tire, but your safety is more important.

If you feel a sudden vibration or ride disturbance while driving, or you suspect your tire or vehicle has been damaged, immediately reduce your speed. Drive with caution until you can safely pull off the road. Stop and inspect the tires for damage. If a tire is under-inflated or damaged, deflate it, remove wheel and replace it with your spare tire and wheel. If you cannot detect a cause, have the vehicle towed to the nearest repair facility or tire dealer to have the vehicle inspected.

### Tire and wheel alignment

A bad jolt from hitting a curb or pothole can cause the front end of your vehicle to become misaligned or cause damage to your tires. If your vehicle seems to pull to one side when you're driving, the wheels may be out of alignment. Have an authorized dealer check the wheel alignment periodically.

Wheel misalignment in the front or the rear can cause uneven and rapid treadwear of your tires and should be corrected by an authorized dealer.

## Tires, Wheels and Loading

Front wheel drive (FWD) vehicles and those with an independent rear suspension (if equipped) may require alignment of all four wheels.

The tires should also be balanced periodically. An unbalanced tire and wheel assembly may result in irregular tire wear.

### Tire rotation

Rotating your tires at the recommended interval (as indicated in the *scheduled maintenance information* that comes with your vehicle) will help your tires wear more evenly, providing better tire performance and longer tire life. Unless otherwise specified, rotate the tires approximately every 5,000 miles (8,000 km).

- Front Wheel Drive (FWD) vehicles (front tires at top of diagram)

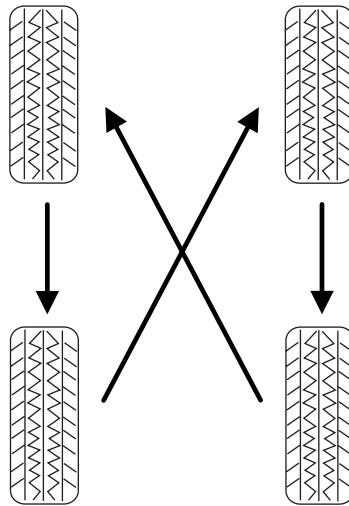

## Tires, Wheels and Loading

- Rear Wheel Drive (RWD) vehicles/Four Wheel Drive (4WD)/ All Wheel Drive (AWD) vehicles (front tires at top of diagram)

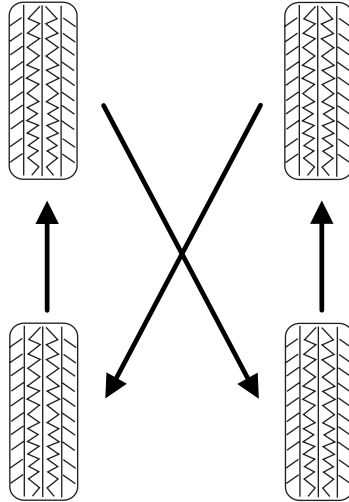

Sometimes irregular tire wear can be corrected by rotating the tires.

**Note:** If your tires show uneven wear ask an authorized dealer to check for and correct any wheel misalignment, tire imbalance or mechanical problem involved before tire rotation.

**Note:** Your vehicle may be equipped with a dissimilar spare tire/wheel. A dissimilar spare tire/wheel is defined as a spare tire and/or wheel that is different in brand, size or appearance from the road tires and wheels. If you have a dissimilar spare tire/wheel it is intended for temporary use only and should not be used in a tire rotation.

**Note:** After having your tires rotated, inflation pressure must be checked and adjusted to the vehicle requirements.

### INFORMATION CONTAINED ON THE TIRE SIDEWALL

Both U.S. and Canada Federal regulations require tire manufacturers to place standardized information on the sidewall of all tires. This information identifies and describes the fundamental characteristics of the tire and also provides a U.S. DOT Tire Identification Number for safety standard certification and in case of a recall.

## Tires, Wheels and Loading

### Information on “P” type tires

P215/65R15 95H is an example of a tire size, load index and speed rating. The definitions of these items are listed below. (Note that the tire size, load index and speed rating for your vehicle may be different from this example.)

1. **P:** Indicates a tire, designated by the Tire and Rim Association (T&RA), that may be used for service on cars, SUVs, minivans and light trucks.

**Note:** If your tire size does not begin with a letter this may mean it is designated by either ETRTO (European Tire and Rim Technical Organization) or JATMA (Japan Tire Manufacturing Association).

2. **215:** Indicates the nominal width of the tire in millimeters from sidewall edge to sidewall edge. In general, the larger the number, the wider the tire.

3. **65:** Indicates the aspect ratio which gives the tire’s ratio of height to width.

4. **R:** Indicates a “radial” type tire.

5. **15:** Indicates the wheel or rim diameter in inches. If you change your wheel size, you will have to purchase new tires to match the new wheel diameter.

6. **95:** Indicates the tire’s load index. It is an index that relates to how much weight a tire can carry. You may find this information in your *Owner’s Guide*. If not, contact a local tire dealer.

**Note:** You may not find this information on all tires because it is not required by federal law.

7. **H:** Indicates the tire’s speed rating. The speed rating denotes the speed at which a tire is designed to be driven for extended periods of time under a standard condition of load and inflation pressure. The tires on your vehicle may operate at different conditions for load and inflation pressure. These speed ratings may need to be adjusted for the difference in conditions. The ratings range from 81 mph (130 km/h) to 186 mph (299 km/h). These ratings are listed in the following chart.

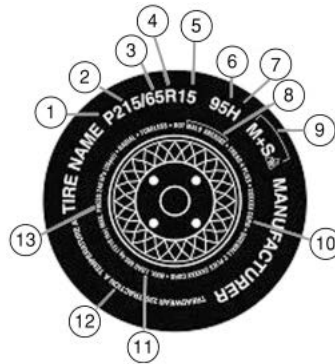

182

2007 Escape Hybrid (ehv)  
Owners Guide (post-2002-fmt)  
USA (fus)

## Tires, Wheels and Loading

**Note:** You may not find this information on all tires because it is not required by federal law.

Letter rating	Speed rating - mph (km/h)
M	81 mph (130 km/h)
N	87 mph (140 km/h)
Q	99 mph (159 km/h)
R	106 mph (171 km/h)
S	112 mph (180 km/h)
T	118 mph (190 km/h)
U	124 mph (200 km/h)
H	130 mph (210 km/h)
V	149 mph (240 km/h)
W	168 mph (270 km/h)
Y	186 mph (299 km/h)

**Note:** For tires with a maximum speed capability over 149 mph (240 km/h), tire manufacturers sometimes use the letters ZR. For those with a maximum speed capability over 186 mph (299 km/h), tire manufacturers always use the letters ZR.

**8. U.S. DOT Tire Identification Number (TIN):** This begins with the letters "DOT" and indicates that the tire meets all federal standards. The next two numbers or letters are the plant code designating where it was manufactured, the next two are the tire size code and the last four numbers represent the week and year the tire was built. For example, the numbers 317 mean the 31st week of 1997. After 2000 the numbers go to four digits. For example, 2501 means the 25th week of 2001. The numbers in between are identification codes used for traceability. This information is used to contact customers if a tire defect requires a recall.

**9. M+S or M/S:** Mud and Snow, or

**AT:** All Terrain, or

**AS:** All Season.

**10. Tire Ply Composition and Material Used:** Indicates the number of plies or the number of layers of rubber-coated fabric in the tire tread and sidewall. Tire manufacturers also must indicate the ply materials in the tire and the sidewall, which include steel, nylon, polyester, and others.

**11. Maximum Load:** Indicates the maximum load in kilograms and pounds that can be carried by the tire. Refer to the Safety Compliance Certification Label, which is located on the B-Pillar or the edge of the driver's door, for the correct tire pressure for your vehicle.

## Tires, Wheels and Loading

### 12. Treadwear, Traction and Temperature Grades

- **Treadwear:** The treadwear grade is a comparative rating based on the wear rate of the tire when tested under controlled conditions on a specified government test course. For example, a tire graded 150 would wear one and one-half (1½) times as well on the government course as a tire graded 100.
- **Traction:** The traction grades, from highest to lowest are AA, A, B, and C. The grades represent the tire's ability to stop on wet pavement as measured under controlled conditions on specified government test surfaces of asphalt and concrete. A tire marked C may have poor traction performance.
- **Temperature:** The temperature grades are A (the highest), B and C, representing the tire's resistance to the generation of heat and its ability to dissipate heat when tested under controlled conditions on a specified indoor laboratory test wheel.

13. **Maximum Permissible Inflation Pressure:** Indicates the tire manufacturers' maximum permissible pressure and/or the pressure at which the maximum load can be carried by the tire. This pressure is normally higher than the manufacturer's recommended cold inflation pressure which can be found on the Safety Compliance Certification Label or Tire Label which is located on the B-Pillar or the edge of the driver's door. The cold inflation pressure should never be set lower than the recommended pressure on the vehicle label.

The tire suppliers may have additional markings, notes or warnings such as standard load, radial tubeless, etc.



## Tires, Wheels and Loading

### Additional information contained on the tire sidewall for “LT” type tires

“LT” type tires have some additional information beyond those of “P” type tires; these differences are described below:

1. **LT:** Indicates a tire, designated by the Tire and Rim Association (T&RA), that is intended for service on light trucks.

#### 2. **Load Range/Load Inflation**

**Limits:** Indicates the tire’s load-carrying capabilities and its inflation limits.

#### 3. **Maximum Load Dual lb. (kg)**

**at psi (kPa) cold:** Indicates the maximum load and tire pressure when the tire is used as a dual; defined as four tires on the rear axle (a total of six or more tires on the vehicle).

4. **Maximum Load Single lb. (kg) at psi (kPa) cold:** Indicates the maximum load and tire pressure when the tire is used as a single; defined as two tires (total) on the rear axle.

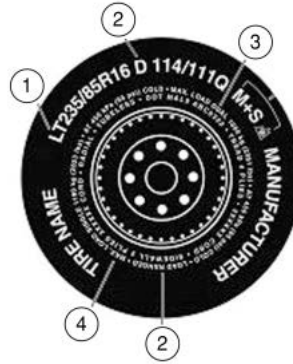

## Tires, Wheels and Loading

### Information on “T” type tires

“T” type tires have some additional information beyond those of “P” type tires; these differences are described below:

T145/80D16 is an example of a tire size.

**Note:** The temporary tire size for your vehicle may be different from this example.

1. **T:** Indicates a type of tire, designated by the Tire and Rim Association (T&RA), that is intended for temporary service on cars, SUVs, minivans and light trucks.

2. **145:** Indicates the nominal width of the tire in millimeters from sidewall edge to sidewall edge. In general, the larger the number, the wider the tire.

3. **80:** Indicates the aspect ratio which gives the tire’s ratio of height to width. Numbers of 70 or lower indicate a short sidewall.

4. **D:** Indicates a “diagonal” type tire.

**R:** Indicates a “radial” type tire.

5. **16:** Indicates the wheel or rim diameter in inches. If you change your wheel size, you will have to purchase new tires to match the new wheel diameter.

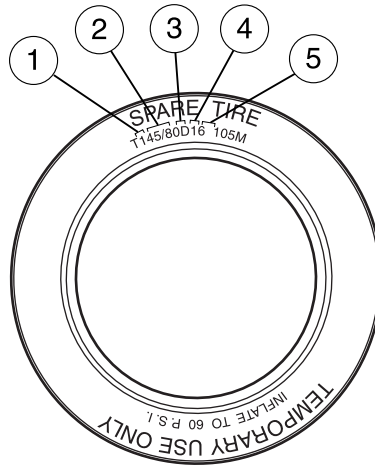

### Location of the tire label

You will find a Tire Label containing tire inflation pressure by tire size and other important information located on the B-Pillar or the edge of the driver’s door. Refer to the payload description and graphic in the *Vehicle loading — with and without a trailer* section.

## Tires, Wheels and Loading

### TIRE PRESSURE MONITORING SYSTEM (TPMS)

Each tire, including the spare (if provided), should be checked monthly when cold and inflated to the inflation pressure recommended by the vehicle manufacturer on the vehicle placard or tire inflation pressure label. (If your vehicle has tires of a different size than the size indicated on the vehicle placard or tire inflation pressure label, you should determine the proper tire inflation pressure for those tires.)

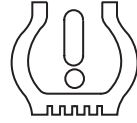

As an added safety feature, your vehicle has been equipped with a tire pressure monitoring system (TPMS) that illuminates a low tire pressure telltale when one or more of your tires is significantly under-inflated. Accordingly, when the low tire pressure telltale illuminates, you should stop and check your tires as soon as possible, and inflate them to the proper pressure. Driving on a significantly under-inflated tire causes the tire to overheat and can lead to tire failure. Under-inflation also reduces fuel efficiency and tire tread life, and may affect the vehicle's handling and stopping ability.

Please note that the TPMS is not a substitute for proper tire maintenance, and it is the driver's responsibility to maintain correct tire pressure, even if under-inflation has not reached the level to trigger illumination of the TPMS low tire pressure telltale.

The Tire Pressure Monitoring System complies with part 15 of the FCC rules and with RSS-210 of Industry Canada. Operation is subject to the following two conditions: (1) This device may not cause harmful interference, and (2) This device must accept any interference received, including interference that may cause undesired operation.



The Tire Pressure Monitoring System is NOT a substitute for manually checking tire pressure. The tire pressure should be checked periodically (at least monthly) using a tire gauge, see *Inflating your tires* in this chapter. Failure to properly maintain your tire pressure could increase the risk of tire failure, loss of control, vehicle rollover and personal injury.

## Tires, Wheels and Loading

### Changing tires with TPMS

**Each road tire is equipped with a tire pressure sensor fastened to the inside rim of the wheel. The pressure sensor is covered by the tire and is not visible unless the tire is removed. The pressure sensor is located opposite (180 degrees) from the valve stem. Care must be taken when changing the tire to avoid damaging the sensor.** It is recommended that you always have your tires serviced by an authorized dealer.

The tire pressure should be checked periodically (at least monthly) using an accurate tire gauge, refer to *Inflating your tires* in this chapter.

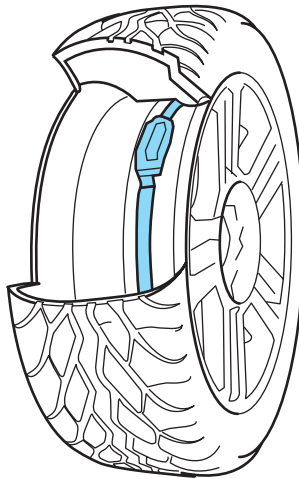

### Understanding your Tire Pressure Monitoring System (TPMS)

The Tire Pressure Monitoring System measures pressure in your four road tires and sends the tire pressure readings to your vehicle. The Low Tire Warning Lamp will turn ON if the tire pressure is significantly low. Once the light is illuminated, your tires are under inflated and need to be inflated to the manufacturer's recommended tire pressure. Even if the light turns ON and a short time later turns OFF, your tire pressure still needs to be checked.

#### ***When your temporary spare tire is installed***

When one of your road tires needs to be replaced with the temporary spare, the TPMS system will continue to identify an issue to remind you that the damaged road wheel/tire needs to be repaired and put back on your vehicle.

To restore the full functionality of the Tire Pressure Monitoring System, have the damaged road wheel/tire repaired and remounted on your vehicle. For additional information, refer to *Changing tires with TPMS* in this section.

#### ***When you believe your system is not operating properly***

The main function of the Tire Pressure Monitoring System is to warn you when your tires need air. It can also warn you in the event the system is

## Tires, Wheels and Loading

no longer capable of functioning as intended. Please refer to the following chart for information concerning your Tire Pressure Monitoring System:

Low Tire Pressure Warning Light	Possible cause	Customer Action Required
Solid Warning Light	Tire(s) under-inflated	1. Check your tire pressure to ensure tires are properly inflated; refer to <i>Inflating your tires</i> in this chapter. 2. After inflating your tires to the manufacturer's recommended inflation pressure as shown on the Tire Label (located on the edge of driver's door or the B-Pillar), the vehicle must be driven for at least two minutes over 20 mph (32 km/h) before the light will turn OFF.
	Spare tire in use	Your temporary spare tire is in use. Repair the damaged road wheel/tire and reinstall it on the vehicle to restore system functionality. For a description on how the system functions, refer to <i>When your temporary spare tire is installed</i> in this section.
	TPMS malfunction	If your tires are properly inflated and your spare tire is not in use and the light remains ON, have the system inspected by your authorized dealer.

## Tires, Wheels and Loading

Low Tire Pressure Warning Light	Possible cause	Customer Action Required
Flashing Warning Light	Spare tire in use	Your temporary spare tire is in use. Repair the damaged road wheel and re-mount it on the vehicle to restore system functionality. For a description of how the system functions under these conditions, refer to <i>When your temporary spare tire is installed</i> in this section.
	TPMS malfunction	If your tires are properly inflated and your spare tire is not in use and the TPMS warning light is still ON, have the system inspected by your authorized dealer.

### ***When inflating your tires***

When putting air into your tires (such as at a gas station or in your garage), the Tire Pressure Monitoring System may not respond immediately to the air added to your tires.

It may take up to two minutes of driving over 20 mph (32 km/h) for the light to turn OFF after you have filled your tires to the recommended inflation pressure.

### ***How temperature affects your tire pressure***

The Tire Pressure Monitoring System (TPMS) monitors tire pressure in each pneumatic tire. While driving in a normal manner, a typical passenger tire inflation pressure may increase approximately 2 to 4 psi (14 to 28 kPa) from a cold start situation. If the vehicle is stationary over night with the outside temperature significantly lower than the daytime temperature, the tire pressure may decrease approximately 3 psi (20.7 kPa) for a drop of 30° F (16.6° C) in ambient temperature. This lower pressure value may be detected by the TPMS as being significantly lower than the recommended inflation pressure and activate the TPMS warning for low tire pressure. If the low tire pressure warning light is ON, visually check each tire to verify that no tire is flat. If one or more tires are flat, repair as necessary. Check air pressure in the road tires. If

## Tires, Wheels and Loading

any tire is under-inflated, carefully drive the vehicle to the nearest location where air can be added to the tires. Inflate all the tires to the recommended inflation pressure.

### USING SNOW TIRES AND TRACTION DEVICES



Snow tires must be the same size and grade as the tires you currently have on your vehicle.

The tires on your vehicle have all-weather treads to provide traction in rain and snow. However, in some climates, using snow tires or traction devices may be necessary.

Follow these guidelines when using snow tires and traction devices:

- SAE class “S” cables should ONLY be used on the front axle for P235/70R16 tires.
- Install cables or chains securely, verifying that the cables or chains do not touch any wiring, brake lines or fuel lines.
- Drive cautiously. If you hear the cables or chains rub or bang against the vehicle, stop and retighten them. If this does not work, remove the cables or chains to prevent vehicle damage.
- Avoid overloading your vehicle.
- Remove the cables or chains when they are no longer needed.
- Do not use cables or chains on dry roads.
- Do not exceed 30 mph (48 km/h) with tire cables or chains on your vehicle.

Consult your authorized dealer for information on other Ford Motor Company approved methods of traction control.

### VEHICLE LOADING – WITH AND WITHOUT A TRAILER

This section will guide you in the proper loading of your vehicle and/or trailer, to keep your loaded vehicle weight within its design rating capability, with or without a trailer. Properly loading your vehicle will provide maximum return of vehicle design performance. Before loading your vehicle, familiarize yourself with the following terms for determining your vehicle’s weight ratings, with or without a trailer, from the vehicle’s Tire Label or Safety Compliance Certification Label:

**Base Curb Weight** – is the weight of the vehicle including a full tank of fuel and all standard equipment. It does not include passengers, cargo, or optional equipment.

## Tires, Wheels and Loading

**Vehicle Curb Weight** – is the weight of your new vehicle when you picked it up from your authorized dealer plus any aftermarket equipment.

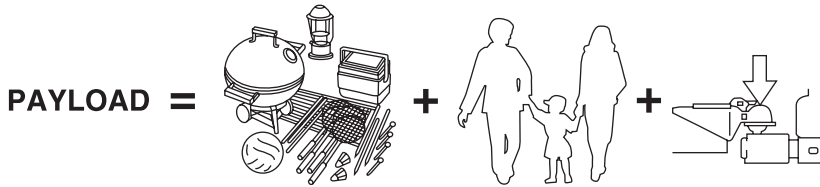

**Payload** – is the combined weight of cargo and passengers that the vehicle is carrying. The maximum payload for your vehicle can be found on the Tire Label on the B-Pillar or the edge of the driver's door (vehicles exported outside the US and Canada may not have a Tire Label). Look for **“THE COMBINED WEIGHT OF OCCUPANTS AND CARGO SHOULD NEVER EXCEED XXX kg OR XXX lb.”** for maximum payload. The payload listed on the Tire Label is the maximum payload for the vehicle as built by the assembly plant. If any aftermarket or authorized-dealer installed equipment has been installed on the vehicle, the weight of the equipment must be subtracted from the payload listed on the Tire Label in order to determine the new payload.



The appropriate loading capacity of your vehicle can be limited either by volume capacity (how much space is available) or by payload capacity (how much weight the vehicle should carry). Once you have reached the maximum payload of your vehicle, do not add more cargo, even if there is space available. Overloading or improperly loading your vehicle can contribute to loss of vehicle control and vehicle rollover.



## Tires, Wheels and Loading

Example only:





### TIRE AND LOADING INFORMATION

SEATING CAPACITY	TOTAL 5	FRONT 2	REAR 3
------------------	---------	---------	--------

The combined weight of occupants and cargo should never exceed : **XXX kg or XXX lbs.**

TIRE	SIZE	COLD TIRE PRESSURE	SEE OWNERS MANUAL FOR ADDITIONAL INFORMATION
FRONT	LT225/75R 16.5E	200 KPA, 29 PSI	
REAR	LT225/75R 16.5E	200 KPA, 29 PSI	
SPARE	T145/80D16 P225/60R17	420 KPA, 60 PSI 200 KPA, 29 PSI	





### TIRE AND LOAD INFORMATION RENSEIGNEMENTS RELATIFS AUX PNEUS ET À LA CHARGE

SEATING CAPACITY NOMBRE DE PLACES	TOTAL XX	FRONT XX AVANT	REAR X ARRIERE
--------------------------------------	----------	-------------------	-------------------

The combined weight of occupants and cargo should never exceed : **XXX kg.**  
La charge du véhicule (occupants et bagages) ne doit jamais dépasser : **XXX lbs.**

TIRE PNEUS	SIZE DIMENSIONS	COLD TIRE PRESSURE PRESSION À FROID	SEE OWNERS MANUAL FOR ADDITIONAL INFORMATION CONSULTER LE GUIDE DU PROPRIETAIRE POUR DE PLUS AMPLES RESEIGNEMENTS
FRONT/ AVANT	LT225/75R 16.5E	200 KPA, 29 PSI	
REAR/ ARRIERE	LT225/75R 16.5E	200 KPA, 29 PSI	
SPARE/ PNEU DE SECOURS	T145/80D16 P225/60R17	420 KPA, 60 PSI 200 KPA, 29 PSI	





**Cargo Weight** – includes all weight added to the Base Curb Weight, including cargo and optional equipment. When towing, trailer tongue load or king pin weight is also part of cargo weight.

**GAW (Gross Axle Weight)** – is the total weight placed on each axle (front and rear) – including vehicle curb weight and all payload.

## Tires, Wheels and Loading

**GAWR (Gross Axle Weight Rating)** – is the maximum allowable weight that can be carried by a single axle (front or rear). **These numbers are shown on the Safety Compliance Certification Label located on the B-Pillar or the edge of the driver's door. The total load on each axle must never exceed its GAWR.**

**Note:** For trailer towing information refer to *Trailer towing* found in this chapter or the *RV and Trailer Towing Guide* provided by your authorized dealer.

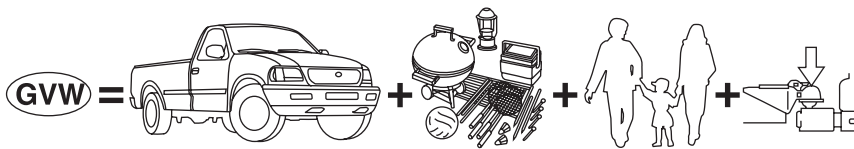

**GVW (Gross Vehicle Weight)** – is the Vehicle Curb Weight + cargo + passengers.

**GVWR (Gross Vehicle Weight Rating)** – is the maximum allowable weight of the fully loaded vehicle (including all options, equipment, passengers and cargo). **The GVWR is shown on the Safety Compliance Certification Label located on the B-Pillar or the edge of the driver's door. The GVW must never exceed the GVWR.**

MFD. BY FORD MOTOR CO.					
DATE: XX/XX	GVWR: XXXXLB/ XXXXKKG				
FRONT GAWR: XXXXL	REAR GAWR: XXXXLB				
XXXXKKG	WITH	XXXXKKG	WITH		
XXXX/XXXXXXX	TIRES	XXXX/XXXXXXX	TIRES		
XXXX.XX	RIMS	XXXX.XX	RIMS		
AT XXX kPa/XX	PSI COLD	AT XXX kPa/XX	PSI COLD		
THIS VEHICLE CONFORMS TO ALL APPLICABLE FEDERAL MOTOR VEHICLE SAFETY AND THEFT PREVENTION STANDARDS IN EFFECT ON THE DATE OF MANUFACTURE SHOWN ABOVE.					
VIN: XXXXXXXXXXXXXXXXX	XXXXX		XXXXX		
TYPE: XXX					
EXT PNT: XX	RC: XX	DSO:			
WB <sup>1</sup> BRK <sup>2</sup> INT TR <sup>3</sup> TP/PS <sup>4</sup> R <sup>5</sup> AXLE <sup>6</sup> TR <sup>7</sup> SPR <sup>8</sup> XXXXX					
XXX X XX X XX X XX XXX					
XXXXXXXXXX XXX XXXX-XXXXXX-XX					



Exceeding the Safety Compliance Certification Label vehicle weight rating limits could result in substandard vehicle handling or performance, engine, transmission and/or structural damage, serious damage to the vehicle, loss of control and personal injury.

## Tires, Wheels and Loading



**GCW (Gross Combined Weight)** – is the weight of the loaded vehicle (GVW) plus the weight of the fully loaded trailer.

**GCWR (Gross Combined Weight Rating)** – is the maximum allowable weight of the vehicle and the loaded trailer – including all cargo and passengers – that the vehicle can handle without risking damage.

(Important: The towing vehicle's braking system is rated for operation at GVWR, not at GCWR.) Separate functional brakes should be used for safe control of towed vehicles and for trailers where the GCW of the towing vehicle plus the trailer exceed the GVWR of the towing vehicle.

**The GCW must never exceed the GCWR.**

**Maximum Loaded Trailer Weight** – is the highest possible weight of a fully loaded trailer the vehicle can tow. It assumes a vehicle with only mandatory options, no cargo (internal or external), a tongue load of 10–15% (conventional trailer) or king pin weight of 15–25% (fifth wheel trailer), and driver only (150 lb. [68 kg]). **Consult your authorized dealer (or the *RV and Trailer Towing Guide* provided by your authorized dealer) for more detailed information.**

**Tongue Load or Fifth Wheel King Pin Weight** – refers to the amount of the weight that a trailer pushes down on a trailer hitch.

**Examples:** For a 5,000 lb. (2,268 kg) conventional trailer, multiply 5,000 by 0.10 and 0.15 to obtain a proper tongue load range of 500 to 750 lb. (227 to 340 kg). For an 11,500 lb. (5,216 kg) fifth wheel trailer, multiply by 0.15 and 0.25 to obtain a proper king pin load range of 1,725 to 2,875 lb. (782 to 1,304 kg)



Do not exceed the GVWR or the GAWR specified on the Safety Compliance Certification Label.



Do not use replacement tires with lower load carrying capacities than the originals because they may lower the vehicle's GVWR and GAWR limitations. Replacement tires with a higher limit than the originals do not increase the GVWR and GAWR limitations.

## Tires, Wheels and Loading



Exceeding any vehicle weight rating limitation could result in serious damage to the vehicle and/or personal injury.

### Steps for determining the correct load limit:

1. Locate the statement “The combined weight of occupants and cargo should never exceed XXX kg or XXX lbs.” on your vehicle’s placard.
2. Determine the combined weight of the driver and passengers that will be riding in your vehicle.
3. Subtract the combined weight of the driver and passengers from XXX kg or XXX lbs.
4. The resulting figure equals the available amount of cargo and luggage load capacity. For example, if the “XXX” amount equals 1,400 lbs. and there will be five 150 lb. passengers in your vehicle, the amount of available cargo and luggage load capacity is 650 lbs. ( $1400 - 750 (5 \times 150) = 650$  lb.). In metric units ( $635 - 340 (5 \times 68) = 295$  kg.)
5. Determine the combined weight of luggage and cargo being loaded on the vehicle. That weight may not safely exceed the available cargo and luggage load capacity calculated in Step 4.
6. If your vehicle will be towing a trailer, load from your trailer will be transferred to your vehicle. Consult this manual to determine how this reduces the available cargo and luggage load capacity of your vehicle.

The following gives you a few examples on how to calculate the available amount of cargo and luggage load capacity:

- Another example for your vehicle with 1400 lb. (635 kg) of cargo and luggage capacity. You decide to go golfing. Is there enough load capacity to carry you, 4 of your friends and all the golf bags? You and four friends average 220 lb. (99 kg) each and the golf bags weigh approximately 30 lb. (13.5 kg) each. The calculation would be:  $1400 - (5 \times 220) - (5 \times 30) = 1400 - 1100 - 150 = 150$  lb. Yes, you have enough load capacity in your vehicle to transport four friends and your golf bags. In metric units, the calculation would be:  $635 \text{ kg} - (5 \times 99 \text{ kg}) - (5 \times 13.5 \text{ kg}) = 635 - 495 - 67.5 = 72.5$  kg.
- A final example for your vehicle with 1400 lb. (635 kg) of cargo and luggage capacity. You and one of your friends decide to pick up cement from the local home improvement store to finish that patio you have been planning for the past 2 years. Measuring the inside of the vehicle with the rear seat folded down, you have room for 12-100 lb. (45 kg) bags of cement. Do you have enough load capacity to

## Tires, Wheels and Loading

transport the cement to your home? If you and your friend each weigh 220 lb. (99 kg), the calculation would be:  $1400 - (2 \times 220) - (12 \times 100) = 1400 - 440 - 1200 = -240$  lb. No, you do not have enough cargo capacity to carry that much weight. In metric units, the calculation would be:  $635 \text{ kg} - (2 \times 99 \text{ kg}) - (12 \times 45 \text{ kg}) = 635 - 198 - 540 = -103$  kg. You will need to reduce the load weight by at least 240 lb. (104 kg). If you remove 3-100 lb. (45 kg) cement bags, then the load calculation would be:

$1400 - (2 \times 220) - (9 \times 100) = 1400 - 440 - 900 = 60$  lb. Now you have the load capacity to transport the cement and your friend home. In metric units, the calculation would be:  $635 \text{ kg} - (2 \times 99 \text{ kg}) - (9 \times 45 \text{ kg}) = 635 - 198 - 405 = 32$  kg.

The above calculations also assume that the loads are positioned in your vehicle in a manner that does not overload the Front or the Rear Gross Axle Weight Rating specified for your vehicle on the Safety Compliance Certification Label found on the edge of the driver's door.

### Special loading instructions for owners of pickup trucks and utility-type vehicles



For important information regarding safe operation of this type of vehicle, see the *Preparing to drive your vehicle* section in the *Driving* chapter of this *Owner's Guide*.



Loaded vehicles may handle differently than unloaded vehicles. Extra precautions, such as slower speeds and increased stopping distance, should be taken when driving a heavily loaded vehicle.

Your vehicle can haul more cargo and people than most passenger cars. Depending upon the type and placement of the load, hauling cargo and people may raise the center of gravity of the vehicle.

### TRAILER TOWING

Trailer towing with your vehicle may require the use of a trailer tow option package.

Trailer towing puts additional loads on your vehicle's engine, transaxle, axle, brakes, tires, and suspension. For your safety and to maximize vehicle performance, be sure to use the proper equipment while towing.

Follow these guidelines to ensure safe towing procedure:

- Stay within your vehicle's load limits.

## Tires, Wheels and Loading

- Thoroughly prepare your vehicle for towing. Refer to *Preparing to tow* in this chapter.
- Use extra caution when driving while trailer towing. Refer to *Driving while you tow* in this chapter.
- Service your vehicle more frequently if you tow a trailer. Refer to the severe duty schedule in the scheduled maintenance guide.
- Do not tow a trailer until your vehicle has been driven at least 800 km (500 miles).
- Refer to the instructions included with towing accessories for the proper installation and adjustment specifications.

Do not exceed the maximum loads listed on the Certification label. For load specification terms found on the label, refer to *Vehicle loading* in this chapter. Remember to figure in the tongue load of your loaded trailer when figuring the total weight.

FWD		
GCWR (Gross Combined Weight Rating)/Trailer Weights		
Engine	Maximum GCWR - lb. (kg)	Trailer Weight Range - lb. (kg)
2.3L	4800 (2177)	1000 (454)
<p><b>Notes:</b> For high altitude operation, reduce GCW by 2% per 1000 ft. (300 meters) elevation. For definitions of terms and instructions on calculating your vehicle's load, refer to <i>Vehicle loading</i> in this chapter. Maximum trailer weights shown. The combined weight of the completed towing vehicle and the loaded trailer must not exceed the GCWR.</p> <p>Your Hybrid vehicle is capable of pulling the maximum trailer weight(s) as specified above. Certain states require electric trailer brakes for trailers over a specified weight. Your Hybrid vehicle electrical system is not equipped to accommodate electric trailer brakes.</p>		

## Tires, Wheels and Loading

4WD		
GCWR (Gross Combined Weight Rating)/Trailer Weights		
Engine	Maximum GCWR - lb. (kg)	Trailer Weight Range - lb. (kg)
2.3L	4960 (2250 )	1000 (454)
<p><b>Notes:</b> For high altitude operation, reduce GCW by 2% per 1000 ft. (300 meters) elevation. For definitions of terms and instructions on calculating your vehicle's load, refer to <i>Vehicle loading</i> in this chapter. Maximum trailer weights shown. The combined weight of the completed towing vehicle and the loaded trailer must not exceed the GCWR.</p> <p>Your Hybrid vehicle is capable of pulling the maximum trailer weight(s) as specified above. Certain states require electric trailer brakes for trailers over a specified weight. Your Hybrid vehicle electrical system is not equipped to accommodate electric trailer brakes.</p>		



Do not exceed the GVWR or the GAWR specified on the certification label.



Towing trailers beyond the maximum recommended gross trailer weight exceeds the limit of the vehicle and could result in engine damage, transmission damage, structural damage, loss of vehicle control, vehicle rollover and personal injury.

### Preparing to tow

Use the proper equipment for towing a trailer and make sure it is properly attached to your vehicle. See your authorized dealer or a reliable trailer dealer if you require assistance.

### Hitches

Do not use hitches that clamp onto the vehicle bumper. Use a load carrying hitch. You must distribute the load in your trailer so that 10–15% of the total weight of the trailer is on the tongue.

### Safety chains

Always connect the trailer's safety chains to hook retainers on the vehicle. To connect the trailer's safety chains, cross the chains under the trailer tongue and allow slack for turning corners.

## Tires, Wheels and Loading

If you use a rental trailer, follow the instructions that the rental agency gives to you.

**Do not attach safety chains to the bumper.**

### Trailer brakes

Electric, manual, automatic or surge-type brakes, if compatible with the vehicle, are safe if installed properly and adjusted to the manufacturer's specifications. The trailer brakes must meet local and Federal regulations.



Do not connect a trailer's hydraulic brake system directly to your vehicle's brake system. Your vehicle may not have enough braking power and your chances of having a collision greatly increase.

The braking system of the tow vehicle is rated for operation at the GVWR not GCWR.

### Trailer lamps

Trailer lamps are required on most towed vehicles. Make sure all running lights, brake lights, turn signals and hazard lights are working. Do not connect trailer lamps directly to your vehicle's tail lamps. This can cause damage to your vehicle's electrical system. See your authorized dealer or trailer rental agency for proper instructions and equipment for hooking up trailer lamps.

### Driving while you tow

When towing a trailer:

- Keep your speed no faster than 70 mph (112 km/h) during the first 500 miles (800 km) of towing a trailer, and don't make full throttle starts.
- Turn off the speed control. The speed control may shut off automatically when you are towing on long, steep grades.
- Consult your local motor vehicle speed regulations for towing a trailer.
- Anticipate stops and brake gradually.
- Do not exceed the GCWR rating or transmission damage may occur.

### Servicing after towing

If you tow a trailer for long distances, your vehicle will require more frequent service intervals. Refer to your *scheduled maintenance information* for more information.

200



## Tires, Wheels and Loading

### Trailer towing tips

- Practice turning, stopping and backing up before starting on a trip to get the feel of the vehicle trailer combination. When turning, make wider turns so the trailer wheels will clear curbs and other obstacles.
- Allow more distance for stopping with a trailer attached.
- If you are driving down a long or steep hill, shift to a lower gear. Do not apply the brakes continuously, as they may overheat and become less effective.
- The trailer tongue weight should be 10–15% of the loaded trailer weight.
- If you will be towing a trailer frequently in hot weather, hilly conditions, at GCW, or any combination of these factors, consider refilling your rear axle with synthetic gear lube if not already so equipped. Refer to the *Maintenance and Specifications* chapter for the lubricant specification. Remember that regardless of the rear axle lube used, do not tow a trailer for the first 500 miles (800 km) of a new vehicle, and that the first 500 miles (800 km) of towing be done at no faster than 70 mph (112 km/h) with no full throttle starts.
- After you have traveled 50 miles (80 km), thoroughly check your hitch, electrical connections and trailer wheel lug nuts.
- Vehicles with trailers should not be parked on a grade. If you must park on a grade, place wheel chocks under the trailer's wheels.

### Launching or retrieving a boat

**Disconnect the wiring to the trailer before backing the trailer into the water. Reconnect the wiring to the trailer after the trailer is removed from the water.**

When backing down a ramp during boat launching or retrieval:

- do not allow the static water level to rise above the bottom edge of the rear bumper.
- do not allow waves to break higher than 6 inches (15 cm) above the bottom edge of the rear bumper.

Exceeding these limits may allow water to enter vehicle components:

- causing internal damage to the components.
- affecting driveability, emissions and reliability.

Replace the rear axle lubricant any time the axle has been submerged in water. Rear axle lubricant quantities are not to be checked or changed unless a leak is suspected or repair required.

## Tires, Wheels and Loading

### RECREATIONAL TOWING

An example of “recreational towing” is towing your vehicle behind a motorhome.

Your vehicle may be “flat-towed” (all wheels on the ground) by shifting the transmission into Neutral. This is permitted for Front Wheel Drive (FWD) or Four-Wheel Drive (4WD) vehicles. Your vehicle may be towed up to a speed of 120 km/h (75 mph) but you should always obey local speed limits.

You also have the option of trailering the vehicle with its front wheels on a dolly (FWD only), or trailering with all four wheels off the ground.

For other towing requirements, refer to *Wrecker towing* in the *Roadside Emergencies* chapter.

### STARTING

#### Positions of the ignition

1. LOCK, locks the gearshift lever and allows key removal.
2. ACCESSORY, allows the electrical accessories such as the radio to operate while the vehicle is not running.
3. RUN, all electrical circuits operational and warning lights will illuminate. This is the position the key is in when you're driving.
4. START, starts the engine, vehicle and electrical power systems.

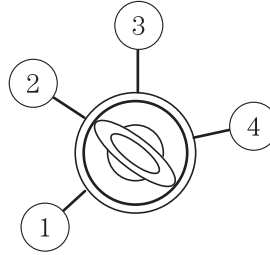

#### Preparing to start your vehicle

Engine starting is controlled by the electronically-controlled Continuously Variable Transaxle (eCVT). For more information on starting the vehicle, refer to *Starting the vehicle* in this chapter.



Extended idling at high engine speeds can produce very high temperatures in the engine and exhaust system, creating the risk of fire or other damage.



Do not park, idle, or drive your vehicle in dry grass or other dry ground cover. The emission system heats up the engine compartment and exhaust system, which can start a fire.



Do not start your vehicle in a closed garage or in other enclosed areas. Exhaust fumes can be toxic. Always open the garage door before you start the engine. See *Guarding against exhaust fumes* in this chapter for more instructions.



If you smell exhaust fumes inside your vehicle, have your dealer inspect your vehicle immediately. Do not drive if you smell exhaust fumes.

#### Important safety precautions

When the engine starts, the idle RPM runs faster to warm the engine. If the engine idle speed does not slow down automatically, have the vehicle checked.

## Driving

Before starting the vehicle:

1. Make sure all occupants buckle their safety belts. For more information on safety belts and their proper usage, refer to the *Seating and Safety Restraints* chapter.
2. Make sure the headlamps and electrical accessories are off.
3. Make sure the parking brake is set.

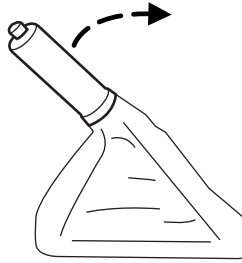

4. Make sure the gearshift is in P (Park).

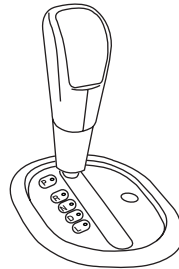

5. Turn the key to 3 (RUN) without turning the key to 4 (START).

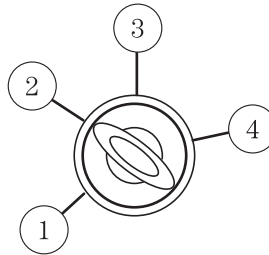

Some warning lights will briefly illuminate. See *Warning lights and chimes* in the *Instrument Cluster* chapter for more information regarding the warning lights.

204

**2007 Escape Hybrid (ehv)**  
**Owners Guide (post-2002-fmt)**  
**USA (fus)**

### Starting the vehicle

1. Turn the key to 3 (RUN) without turning the key to 4 (START). If there is difficulty in turning the key, rotate the steering wheel until the key turns freely. This condition may occur when:

- the front wheels are turned
- a front wheel is against the curb

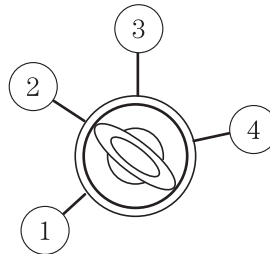

2. Turn the key to 4 (START), then release the key. After the vehicle has been started, a vehicle outlined and illuminated in green (also called the Ready Indicator Light) will light in the instrument cluster to indicate the vehicle is on. This indicator will remain illuminated while the vehicle is on, whether the engine is running or not, to indicate the vehicle is capable of movement (using its electric motor, engine, or both).



**Note:** After starting the vehicle, the engine may stop running to conserve fuel after it is warmed-up and the high voltage battery is sufficiently charged.

**Note:** If the vehicle does not start, put the gearshift lever into P (Park), turn the ignition off, then attempt to start the vehicle again. If the vehicle still does not start, it may require refueling, jump starting, resetting of the fuel pump/high voltage shut-off switches or service. For information on jump starting the vehicle and resetting the fuel pump/high voltage shut-off switches, refer to the *Jump starting your vehicle (low voltage [underhood] battery only)* section, the *Jump starting the high voltage battery* section, and the *Fuel pump/High voltage shut-off switches* section found in the *Roadside Emergencies* chapter.

### Guarding against exhaust fumes

Carbon monoxide is present in exhaust fumes. Take precautions to avoid its dangerous effects.



If you smell exhaust fumes inside your vehicle, have your dealer inspect your vehicle immediately. Do not drive if you smell exhaust fumes.

## Driving

### Important ventilating information

If the engine is idling while the vehicle is stopped for a long period of time, open the windows at least one inch (2.5 cm) or adjust the heating or air conditioning to bring in fresh air.

### ENGINE BLOCK/HIGH VOLTAGE BATTERY HEATER (IF EQUIPPED)

An engine block/high voltage battery heater warms the engine coolant and high voltage battery cells which aids in starting, vehicle performance and heater/defroster performance in cold weather. Use of an engine block/high voltage battery heater is strongly recommended if you live in a region where temperatures reach -10°F (-23°C) or below. For best results, plug the heater in at least three hours before starting the vehicle. The heater can be plugged in the night before starting the vehicle.



To reduce the risk of electrical shock, do not use your heater with ungrounded electrical systems or two-pronged (cheater) adapters.

### BRAKES

Occasional brake noise is normal. If a metal-to-metal, continuous grinding or continuous squeal sound is present, the brake linings may be worn-out and should be inspected by an authorized dealer. If the vehicle has continuous vibration or shudder in the steering wheel while braking, the vehicle should be inspected by an authorized dealer.

Refer to *Brake system warning light* in the *Instrument Cluster* chapter for information on the brake system warning light.



Under normal operating conditions, brake dust may accumulate on the wheels. Some brake dust is inevitable as brakes wear and does not contribute to brake noise. The use of modern friction materials with emphasis on improved performance and environmental considerations can lead to more dust than in the past. Brake dust can be cleaned by weekly washing with soapy water and a soft sponge. Heavier deposits can be removed with Motorcraft Wheel and Tire Cleaner (ZC-37-A).

### Four-wheel anti-lock brake system (ABS)

Your vehicle is equipped with an Anti-lock Braking System (ABS). This system helps you maintain steering control during emergency stops by

206

2007 Escape Hybrid (ehv)  
Owners Guide (post-2002-fmt)  
USA (fus)

keeping the brakes from locking. The hydraulic brake system used for regenerative braking is different from other vehicles. The noise from the ABS pump motor and the brake pedal pulsation are much less than on vehicles with conventional ABS. Noise and pedal pulsation during ABS may not be noticed.

The sliding car symbol in the instrument cluster will be illuminated during ABS braking.



The hydraulic brake system used for regenerative braking will charge its hydraulic system at the beginning of a trip and discharge the system at the end of each trip. You may notice a pumping sound when you enter the vehicle or a venting sound a few minutes after parking the vehicle.

### **Using ABS**

When hard braking is required, apply continuous force on the brake pedal; do not pump the brake pedal since this will reduce the effectiveness of the ABS and will increase your vehicle's stopping distance. The ABS will be activated immediately, allowing you to retain steering control during hard braking and on slippery surfaces. However, the ABS does not decrease stopping distance.

### **ABS warning lamp**

The ABS lamp in the instrument cluster momentarily illuminates when the ignition is turned on. If the light does not illuminate during start up, remains on or flashes, the ABS may be disabled and may need to be serviced

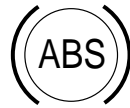

Even when the ABS is disabled, normal braking is still effective. (If your BRAKE warning lamp illuminates with the parking brake released, have your brake system serviced immediately.)



### **Regenerative Braking System (RBS)**

Your vehicle uses a feature known as regenerative braking. This is used to simulate the engine braking of an internal combustion engine and assist the standard brake system while recovering some of the energy of

## Driving

motion back into the battery to improve fuel economy. The standard brake system is designed to fully stop the car if regenerative braking is not available. During regenerative braking, the motor is spun as a generator to create electrical current. This recharges the high voltage battery and slows the vehicle. In effect, once the accelerator pedal is released, the motor changes from an energy user to an energy producer.

When the accelerator pedal is released or the brake pedal is applied, the brake controller automatically detects the amount of deceleration requested and optimizes how much of the deceleration will be produced by regenerative braking. The remaining portion is generated by standard friction braking. When the battery is almost fully charged, the amount of regenerative braking is limited to avoid overcharging, and the requested deceleration is produced by standard friction braking alone.

Regenerative braking does not take the place of the standard friction brakes; it only assists them. Regenerative braking has also been designed to interact with the anti-lock brake system (ABS). Regenerative braking is disabled when the ABS is activated or the battery is fully charged.

### Parking brake

To set the parking brake, pull the handle up as far as possible. The BRAKE warning lamp will illuminate and will remain illuminated until the parking brake is released.

To release, press and hold the button, pull the handle up slightly, then push the handle down.



Always set the parking brake fully and make sure that the gearshift is securely latched in P (Park).

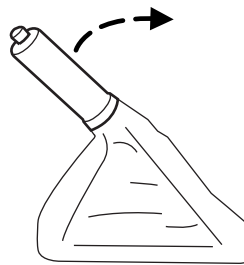

## STEERING

Your vehicle is equipped with an Electric Power-Assisted Steering (EPAS) system. There is no fluid reservoir to check or fill.

If your vehicle loses electrical power while you are driving (or if the ignition is turned off), you can steer the vehicle manually, but it takes



## Driving

more effort. Under extreme usage conditions, the steering effort may increase. This occurs to prevent overheating and permanent damage to your steering system. If this should occur, you will neither lose the ability to steer the vehicle manually nor will it cause permanent damage. Typical steering and driving maneuvers will allow the system to cool and steering assist will return to normal.

If the steering wanders or pulls, check for:

- an improperly inflated tire
- uneven tire wear
- loose or worn suspension components
- loose or worn steering components
- improper steering alignment

A high crown in the road or high crosswinds may also make the steering seem to wander/pull.

### PREPARING TO DRIVE



Utility vehicles have a significantly higher rollover rate than other types of vehicles.



In a rollover crash, an unbelted person is significantly more likely to die than a person wearing a seat belt.

Your vehicle has larger tires and increased ground clearance, giving the vehicle a higher center of gravity than a passenger car.



Vehicles with a higher center of gravity such as utility and four-wheel drive vehicles handle differently than vehicles with a lower center of gravity. Utility and four-wheel drive vehicles are **not** designed for cornering at speeds as high as passenger cars any more than low-slung sports cars are designed to perform satisfactorily under off-road conditions. Avoid sharp turns, excessive speed and abrupt maneuvers in these vehicles. Failure to drive cautiously could result in an increased risk of loss of vehicle control, vehicle rollover, personal injury and death.



Loaded vehicles, with a higher center of gravity, may handle differently than unloaded vehicles. Extra precautions such as slower speeds and increased stopping distance should be taken when driving a heavily loaded vehicle.

## Driving

### AUTOMATIC TRANSMISSION OPERATION

#### Brake-shift interlock

This vehicle is equipped with a brake-shift interlock feature that prevents the gearshift lever from being moved from P (Park) when the ignition is in the RUN position unless brake pedal is depressed.

If you cannot move the gearshift lever out of P (Park) with ignition in the RUN position and the brake pedal depressed, it is possible that a fuse has blown or the vehicle's brake lamps are not operating properly. Refer to *Fuses and relays* in the *Roadside Emergencies* chapter.

If the fuse is not blown, perform the following procedure:

1. Apply the parking brake.
2. Using a screwdriver or similar tool, carefully pry out the small, round, tethered Brake Transmission Shift Interlock (BTSI) cover cap located to the right of the gearshift lever.

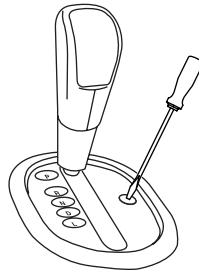

3. Depress the brake pedal and then start the vehicle.

4. Insert a screwdriver or similar tool straight down into the access hole and press downward while pulling the gearshift lever out of the P (Park) position and into the N (Neutral) position.

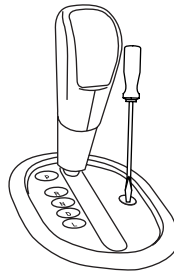



5. Remove tool and reinstall BTSI tethered cover cap.
6. Release the parking brake and drive normally.



Do not drive your vehicle until you verify that the brake lamps are working.

## Driving

 Always set the parking brake fully and make sure the gearshift is latched in P (Park). Turn the ignition to the LOCK position and remove the key whenever you leave your vehicle.

 If the parking brake is fully released, but the brake warning lamp remains illuminated, the brakes may not be working properly. See your authorized dealer as soon as possible.

### Understanding the gearshift positions of the electronically-controlled Continuously Variable Transaxle (eCVT)

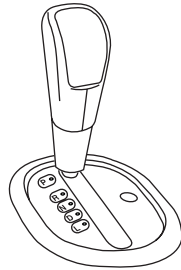

#### **P (Park)**

This position locks the transaxle and prevents the front wheels from turning.

To put your vehicle in gear:

- Start the engine
- Release the parking brake
- Depress the brake pedal
- Move the gearshift lever into the desired gear

To put your vehicle in P (Park):

- Come to a complete stop
- Move the gearshift lever and securely latch it in P (Park)

 Always set the parking brake fully and make sure the gearshift is latched in P (Park). Turn the ignition to the LOCK position and remove the key whenever you leave your vehicle.

## Driving

### **R (Reverse)**

With the gearshift lever in R (Reverse), the vehicle will move backward. Always come to a complete stop before shifting into and out of R (Reverse).

### **N (Neutral)**

With the gearshift lever in N (Neutral), the vehicle is free to roll; hold the brake pedal down while in this position. Because of the unique nature of the hybrid vehicle, the engine will not start in the N (Neutral) position.

The vehicle does not charge the high voltage battery in the N (Neutral) position. Do not idle the vehicle in N (Neutral) for extended periods as this will discharge your high voltage battery.

### **D (Drive)**

The normal driving position for the best fuel economy.

### **L (Low)**

- Provides maximum engine braking.
- The transmission may be shifted into L (Low) at any vehicle speed.



When parking, do not use the gearshift in place of the parking brake. Always set the parking brake fully and make sure that the gearshift is securely latched in P (Park). Turn off the ignition whenever you leave your vehicle. Never leave your vehicle unattended while it is running. If you do not take these precautions, your vehicle may move unexpectedly and injure someone.

### **If your vehicle gets stuck in mud or snow**

If your vehicle gets stuck in mud or snow, it may be rocked out by shifting between forward and reverse gears, stopping between shifts in a steady pattern. Press lightly on the accelerator in each gear.

**Do not rock the vehicle if the engine is not at normal operating temperature or damage to the transmission may occur.**

**Do not rock the vehicle for more than a minute or damage to the transmission and tires may occur, or the engine may overheat.**

### **REVERSE SENSING SYSTEM (IF EQUIPPED)**

The Reverse Sensing System (RSS) sounds a tone to warn the driver of obstacles near the rear bumper when R (Reverse) is selected and the

## Driving

vehicle is moving at speeds less than 3 mph (5 km/h). The system is not effective at speeds above 3 mph (5 km/h) and may not detect certain angular or moving objects.



To help avoid personal injury, please read and understand the limitations of the reverse sensing system as contained in this section. Reverse sensing is only an aid for some (generally large and fixed) objects when moving in reverse on a flat surface at “parking speeds”. Inclement weather may also affect the function of the RSS; this may include reduced performance or a false activation.



To help avoid personal injury, always use caution when in reverse and when using the RSS.



This system is not designed to prevent contact with small or moving objects. The system is designed to provide a warning to assist the driver in detecting large stationary objects to avoid damaging the vehicle. The system may not detect smaller objects, particularly those close to the ground.



Certain add-on devices such as large trailer hitches, bike or surfboard racks and any device that may block the normal detection zone of the RSS system may create false beeps.

## Driving

The RSS detects obstacles up to 6 feet (1.8 meters) from the rear bumper with a decreased coverage area at the outer corners of the bumper, (refer to the figures for approximate zone coverage areas). As you move closer to the obstacle, the rate of the tone increases. When the obstacle is less than 10 inches (25.0 cm) away, the tone will sound continuously. If the RSS detects a stationary or receding object further than 10 inches (25.0 cm) from the side of the vehicle, the tone will sound for only three seconds. Once the system detects an object approaching, the tone will sound again.

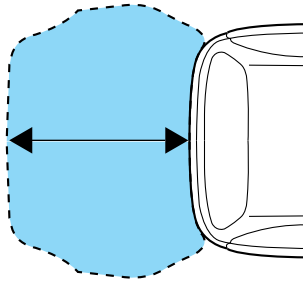
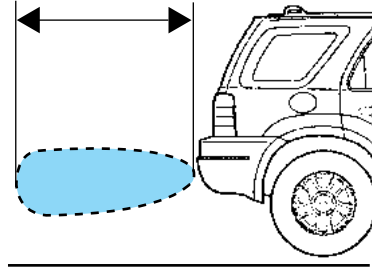

The RSS automatically turns on when the gear selector is placed in R (Reverse) and the ignition is on. An RSS control allows the driver to turn the RSS on and off. To turn the RSS off, the ignition must be on. The system will remain off until either the RSS control is pressed again or the ignition is turned off, then on again. An indicator light on the control will illuminate when the system is turned off. If the indicator light illuminates when the RSS is not turned off, it may indicate a failure in the RSS.



**Keep the RSS sensors (located on the rear bumper/fascia) free from snow, ice and large accumulations of dirt (do not clean the sensors with sharp objects). If the sensors are covered, it will affect the accuracy of the RSS.**

**If your vehicle sustains damage to the rear bumper/fascia, leaving it misaligned or bent, the sensing zone may be altered causing inaccurate measurement of obstacles or false alarms.**

### FOUR WHEEL DRIVE (4WD) SYSTEM (IF EQUIPPED)



For important information regarding safe operation of this type of vehicle, see *Preparing to drive your vehicle* in this chapter.

Your vehicle is equipped with an intelligent 4WD System that continuously monitors vehicle conditions and automatically adjusts the power distribution between the front and rear wheels. It combines transparent all-surface operation with highly capable four-wheel drive.

The 4WD system is always active and requires no driver input. It is capable of handling all road conditions, including street and highway driving as well as off-road and winter driving.

During very extreme off-road events, the 4WD system has a heat protection mode to protect itself from damage. If the system detects an overheat condition, it will enter a locked mode. If the heat in the 4WD system continues to rise in locked mode, it will disable itself. To exit heat protection mode, simply stop the vehicle and allow it to cool for five minutes with the key in the 3 (RUN) position.

#### 4WD system messages in Message Center

- **SERVICE 4WD:** Displayed when the 4WD system is not operating properly. If the warning stays on or continues to come on, contact your authorized dealer as soon as possible.
- **4WD LOCKED TEMPORARILY:** Displayed when 4WD system is temporarily locked.
- **4WD DISABLED TEMPORARILY:** Displayed when 4WD system is temporarily disabled.
- **4WD AUTO RESTORED:** Displayed when the 4WD system function is restored to normal operation.

#### Driving off-road with truck and utility vehicles

4WD vehicles are specially equipped for driving on sand, snow, mud and rough terrain and have operating characteristics that are somewhat different from conventional vehicles, both on and off the road.

#### *How your vehicle differs from other vehicles*

Truck and utility vehicles can differ from some other vehicles. Your vehicle may be higher to allow it to travel over rough terrain without getting hung up or damaging underbody components.

The differences that make your vehicle so versatile also make it handle differently than an ordinary passenger car.

## Driving

Maintain steering wheel control at all times, especially in rough terrain. Since sudden changes in terrain can result in abrupt steering wheel motion, make sure you grip the steering wheel from the outside. Do not grip the spokes.

Drive cautiously to avoid vehicle damage from concealed objects such as rocks and stumps.

You should either know the terrain or examine maps of the area before driving. Map out your route before driving in the area. To maintain steering and braking control of your vehicle, you must have all four wheels on the ground and they must be rolling, not sliding or spinning.

### **Basic operating principles**

- Drive slower in strong crosswinds which can affect the normal steering characteristics of your vehicle.
- Be extremely careful when driving on pavement made slippery by loose sand, water, gravel, snow or ice.

### **If your vehicle goes off the edge of the pavement**

- If your vehicle goes off the edge of the pavement, slow down, but avoid severe brake application, and ease the vehicle back onto the pavement only after reducing your speed. Do not turn the steering wheel too sharply while returning to the road surface.
- It may be safer to stay on the apron or shoulder of the road and slow down gradually before returning to the pavement. You may lose control if you do not slow down or if you turn the steering wheel too sharply or abruptly.
- It often may be less risky to strike small objects, such as highway reflectors, with minor damage to your vehicle rather than attempt a sudden return to the pavement which could cause the vehicle to slide sideways out of control or roll over. Remember, your safety and the safety of others should be your primary concern.



Vehicles with a higher center of gravity such as utility and four-wheel drive vehicles handle differently than vehicles with a lower center of gravity. Utility and four-wheel drive vehicles are **not** designed for cornering at speeds as high as passenger cars any more than low-slung sports cars are designed to perform satisfactorily under off-road conditions. Avoid sharp turns, excessive speed and abrupt maneuvers in these vehicles. Failure to drive cautiously could result in an increased risk of loss of vehicle control, vehicle rollover, personal injury and death.



## Driving

### ***If your vehicle gets stuck***

If your vehicle gets stuck in mud or snow it may be rocked out by shifting between forward and reverse gears, stopping between shifts, in a steady pattern. Press lightly on the accelerator in each gear.

**Do not rock the vehicle if the engine is not at normal operating temperature or damage to the transmission may occur.**

**Do not rock the vehicle for more than a few minutes or damage to the transmission and tires may occur or the engine may overheat.**



Always set the parking brake fully and make sure the gearshift is latched in P (Park). Turn the ignition to the LOCK position and remove the key whenever you leave your vehicle.



If the parking brake is fully released, but the brake warning lamp remains illuminated, the brakes may not be working properly. See your authorized dealer.



Do not spin the wheels at over 35 mph (56 km/h). The tires may fail and injure a passenger or bystander.

### ***Emergency maneuvers***

- In an unavoidable emergency situation where a sudden sharp turn must be made, remember to avoid “over-driving” your vehicle, i.e., turn the steering wheel only as rapidly and as far as required to avoid the emergency. Excessive steering will result in less vehicle control, not more. Additionally, smooth variations of the accelerator and/or brake pedal pressure should be utilized if changes in vehicle speed are required. Avoid abrupt steering, acceleration or braking which could result in an increased risk of loss of vehicle control, vehicle rollover and/or personal injury. Use all available road surface to return the vehicle to a safe direction of travel.
- In the event of an emergency stop, avoid skidding the tires and do not attempt any sharp steering wheel movements.

## Driving



Vehicles with a higher center of gravity such as utility and four-wheel drive vehicles handle differently than vehicles with a lower center of gravity. Utility and four-wheel drive vehicles are **not** designed for cornering at speeds as high as passenger cars any more than low-slung sports cars are designed to perform satisfactorily under off-road conditions. Avoid sharp turns, excessive speed and abrupt maneuvers in these vehicles. Failure to drive cautiously could result in an increased risk of loss of vehicle control, vehicle rollover, personal injury and death.

- If the vehicle goes from one type of surface to another (i.e., from concrete to gravel) there will be a change in the way the vehicle responds to a maneuver (steering, acceleration or braking). Again, avoid these abrupt inputs.

### **Sand**

When driving over sand, try to keep all four wheels on the most solid area of the trail. Avoid reducing the tire pressures and drive steadily through the terrain. Apply the accelerator slowly and avoid spinning the wheels.

Avoid excessive speed because vehicle momentum can work against you and cause the vehicle to become stuck to the point that assistance may be required from another vehicle. Remember, you may be able to back out the way you came if you proceed with caution.

### **Mud and water**

If you must drive through high water, drive slowly. Traction or brake capability may be limited.

When driving through water, determine the depth; avoid water higher than the bottom of the hubs (if possible) and proceed slowly. If the ignition system gets wet, the vehicle may stall.

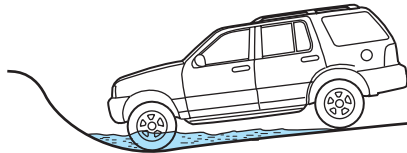

Once through water, always try the brakes. Wet brakes do not stop the vehicle as effectively as dry brakes. Drying can be improved by moving your vehicle slowly while applying light pressure on the brake pedal.

Be cautious of sudden changes in vehicle speed or direction when you are driving in mud. Even 4WD vehicles can lose traction in slick mud. As when you are driving over sand, apply the accelerator slowly and avoid

## Driving

spinning your wheels. If the vehicle does slide, steer in the direction of the slide until you regain control of the vehicle.

If the transmission, transfer case or front axle are submerged in water, their fluids should be checked and changed, if necessary.

### **Driving through deep water may damage the transmission.**

If the front or rear axle is submerged in water, the axle lubricant should be replaced.

After driving through mud, clean off residue stuck to rotating driveshafts and tires. Excess mud stuck on tires and rotating driveshafts causes an imbalance that could damage drive components.

“Tread Lightly” is an educational program designed to increase public awareness of land-use regulations and responsibilities in our nation’s wilderness areas. Ford Motor

Company joins the U.S. Forest Service and the Bureau of Land Management in encouraging you to help preserve our national forest and other public and private lands by “treading lightly.”



### **Driving on hilly or sloping terrain**

Although natural obstacles may make it necessary to travel diagonally up or down a hill or steep incline, you should always try to drive straight up or straight down. **Avoid driving crosswise or turning on steep slopes or hills.** A danger lies in losing traction, slipping sideways and possibly rolling over. Whenever driving on a hill, determine beforehand the route you will use. Do not drive over the crest of a hill without seeing what conditions are on the other side. Do not drive in reverse over a hill without the aid of an observer.

If you do stall out, do not try to turn around because you might roll over. It is better to back down to a safe location.

Apply just enough power to the wheels to climb the hill. Too much power will cause the tires to slip, spin or lose traction, resulting in loss of vehicle control.

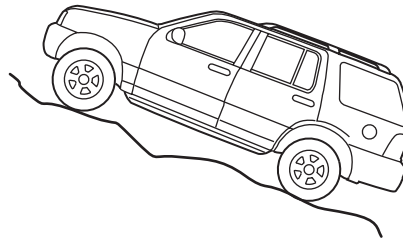

## Driving

Do not descend a hill in N (Neutral) and avoid sudden hard braking as you could lose control.

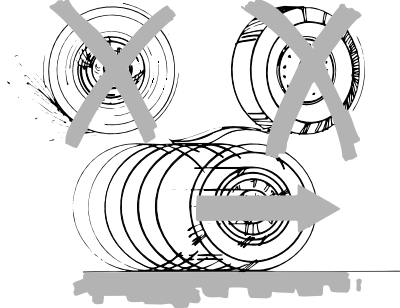

Since your vehicle has anti-lock brakes, apply the brakes steadily. Do not “pump” the brakes.

### **Driving on snow and ice**

4WD vehicles have advantages over 2WD vehicles in snow and ice but can skid like any other vehicle.

Should you start to slide while driving on snowy or icy roads, turn the steering wheel in the direction of the slide until you regain control.

Avoid sudden applications of power and quick changes of direction on snow and ice. Apply the accelerator slowly and steadily when starting from a full stop.

Avoid sudden braking as well. Although a 4WD vehicle may accelerate better than a two-wheel drive vehicle in snow and ice, it won't stop any faster, because as in other vehicles, braking occurs at all four wheels. Do not become overconfident as to road conditions.

Make sure you allow sufficient distance between you and other vehicles for stopping; drive slower than usual. Since your vehicle is equipped with a Four Wheel Anti-Lock Brake System (ABS), apply the brake steadily. Do not “pump” the brakes. Refer to the *Brakes* section of this chapter for additional information on the operation of the anti-lock brake system.

4WD vehicles should be driven with traction devices as referred to in *Using snow tires and traction devices* in the *Tires, Wheels and Loading* chapter.

### **Maintenance and Modifications**

The suspension and steering systems on your vehicle have been designed and tested to provide durable load carrying capability and predictable performance whether loaded or empty. For this reason, Ford Motor Company strongly recommends that you do not make modifications such

## Driving

as adding or removing parts (such as lift kits or stabilizer bars) or using replacement parts not equivalent to the original factory equipment.

Any modifications to a vehicle that raise the center of gravity can make it more likely the vehicle will roll over as a result of a loss of control. Ford Motor Company recommends that caution be used with any vehicle equipped with a high load or device (such as ladder racks or pickup box cover).

Failure to maintain your vehicle properly may void the warranty, increase your repair cost, reduce vehicle performance and operational capabilities and adversely affect driver and passenger safety. Frequent inspection of vehicle chassis components is recommended if the vehicle is subjected to heavy off-road usage.

### DRIVING THROUGH WATER

If driving through deep or standing water is unavoidable, proceed very slowly especially when the depth is not known. Never drive through water that is higher than the bottom of the wheel rims (for cars) or the bottom of the hubs (for trucks).

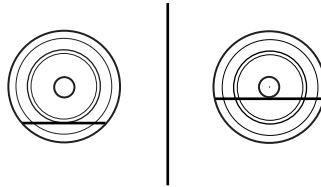

When driving through water, traction or brake capability may be limited. Also, water may enter your engine's air intake and severely damage your engine or your vehicle may stall. **Driving through deep water where the transmission vent tube is submerged may allow water into the transmission and cause internal transmission damage.**

**Once through the water, always dry the brakes by moving your vehicle slowly while applying light pressure on the brake pedal.**

Wet brakes do not stop the vehicle as quickly as dry brakes.

## Roadside Emergencies

### ROADSIDE ASSISTANCE

#### Getting roadside assistance

To fully assist you should you have a vehicle concern, Ford Motor Company offers a complimentary roadside assistance program. This program is separate from the New Vehicle Limited Warranty. The service is available:

- 24-hours, seven days a week
- for the New Vehicle Limited Warranty period of three years or 36,000 miles (60,000 km), whichever occurs first on Ford and Mercury vehicles, and four years or 50,000 miles (80,000 km) on Lincoln vehicles.

Roadside assistance will cover:

- a flat tire change with a good spare (except Ford GT which has a tire inflation kit)
- battery jump start
- lock-out assistance (key replacement cost is the customer's responsibility)
- fuel delivery – Independent Service Contractors, if not prohibited by state, local or municipal law shall deliver up to 2.0 gallons (7.5L) of gasoline or 5 gallons (18.9L) of diesel fuel to a disabled vehicle. Fuel delivery service is limited to two no-charge occurrences within a 12-month period.
- winch out – available within 100 feet (30.5 meters) of a paved or county maintained road, no recoveries.
- towing – Ford/Mercury/Lincoln eligible vehicle towed to an authorized dealer within 35 miles (56.3 km) of the disablement location or to the nearest authorized dealer. If a member requests to be towed to an authorized dealer more than 35 miles (56.3 km) from the disablement location, the member shall be responsible for any mileage costs in excess of 35 miles (56.3 km).

Trailers shall be covered up to \$100 if the disabled eligible vehicle requires service at the nearest authorized dealer. If the trailer is disabled, but the towing vehicle is operational, the trailer does not qualify for any roadside services.

#### **Canadian customers refer to your Owner Information Guide for information on:**

- coverage period

222

*2007 Escape Hybrid (ehv)  
Owners Guide (post-2002-fmt)  
USA (fus)*

## Roadside Emergencies

- exact fuel amounts
- towing of your disabled vehicle
- emergency travel expense reimbursement
- travel planning benefits

### Using roadside assistance

Complete the roadside assistance identification card and place it in your wallet for quick reference. In the United States, this card is found in the Owner Guide portfolio in the glove compartment. In Canada, the card is found in the *Owner Information Guide* in the glove compartment.

U.S. Ford or Mercury vehicle customers who require roadside assistance, call 1-800-241-3673; Lincoln vehicle customers call 1-800-521-4140.

Canadian customers who require roadside assistance, call 1-800-665-2006.

If you need to arrange roadside assistance for yourself, Ford Motor Company will reimburse a reasonable amount. To obtain reimbursement information, U.S. Ford or Mercury vehicles customers call 1-800-241-3673; Lincoln vehicle customers call 1-800-521-4140.

Canadian customers who need to obtain reimbursement information, call 1-800-665-2006.

### Roadside coverage beyond basic warranty

In the United States, you may purchase additional roadside assistance coverage beyond this period through the Ford Auto Club by contacting your authorized dealer.

Similarly in Canada, for uninterrupted Roadside Assistance coverage, you may purchase extended coverage prior to your Basic Warranty's Roadside Assistance expiring. For more information and enrollment, contact 1-877-294-2582 or visit our website at [www.ford.ca](http://www.ford.ca).

### HAZARD FLASHER CONTROL

The hazard flasher is located on the instrument panel by the radio. The hazard flashers will operate when the ignition is in any position or if the key is not in the ignition.

Push in the flasher control and all front and rear direction signals will

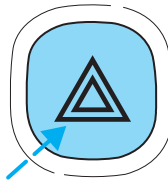

## Roadside Emergencies

flash. Press the flasher control again to turn them off. Use it when your vehicle is disabled and is creating a safety hazard for other motorists.

**Note:** With extended use, the flasher may run down your low voltage (underhood) battery.

### FUEL PUMP/HIGH VOLTAGE SHUT-OFF SWITCHES

The fuel pump shut-off switch and high voltage shut-off switch stop the electric fuel pump from sending fuel to the engine and shut off power from the high voltage battery when your vehicle receives a substantial physical jolt.

After an accident, if the engine does not start, one or both of the switches may have been activated.

The fuel pump shut-off switch is located in the front passenger's footwell, behind a flip-up cover.

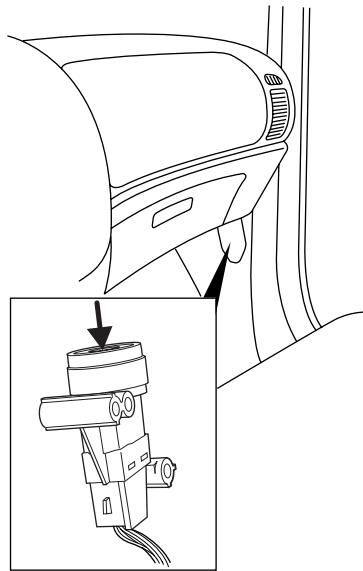



## Roadside Emergencies

The high voltage shut-off switch is located in the cargo area on the passenger side of the vehicle in the jack compartment, behind the jack access door.

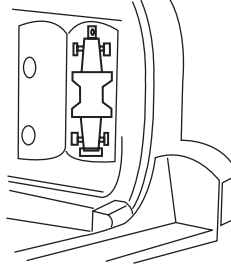

To reset the switch(es):

1. Turn the ignition to LOCK.
2. Check the fuel system for leaks.
3. If no leaks are apparent, reset the switch by pushing in on the reset button. Both switches should be checked and reset.
4. Turn the ignition to RUN.
5. Wait a few seconds and return the key to LOCK.
6. Make another check for leaks.

If you see or smell fuel, do not reset the fuel pump shut-off or try to start your vehicle; you could injure yourself or others. Have all the passengers get out of the vehicle and call the local fire department or a towing service.

### FUSES AND RELAYS

#### Fuses

If electrical components in the vehicle are not working, a fuse may have blown. Blown fuses are identified by a broken wire within the fuse. Check the appropriate fuses before replacing any electrical components.

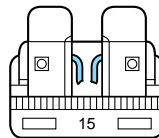

**Note:** Always replace a fuse with one that has the specified amperage rating. Using a fuse with a higher amperage rating can cause severe wire damage and could start a fire.

## Roadside Emergencies

### Standard fuse amperage rating and color

COLOR					
Fuse rating	Mini fuses	Standard fuses	Maxi fuses	Cartridge maxi fuses	Fuse link cartridge
2A	Grey	Grey	—	—	—
3A	Violet	Violet	—	—	—
4A	Pink	Pink	—	—	—
5A	Tan	Tan	—	—	—
7.5A	Brown	Brown	—	—	—
10A	Red	Red	—	—	—
15A	Blue	Blue	—	—	—
20A	Yellow	Yellow	Yellow	Blue	Blue
25A	Natural	Natural	—	—	—
30A	Green	Green	Green	Pink	Pink
40A	—	—	Orange	Green	Green
50A	—	—	Red	Red	Red
60A	—	—	Blue	—	Yellow
70A	—	—	Tan	—	Brown
80A	—	—	Natural	—	Black

## Roadside Emergencies

### Passenger compartment fuse panel

The fuse panel is located on the right-hand side of the center console, by the instrument panel. Remove the panel cover to access the fuses.

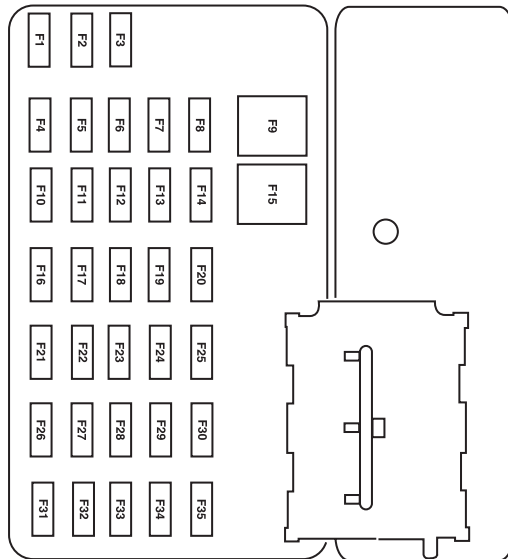
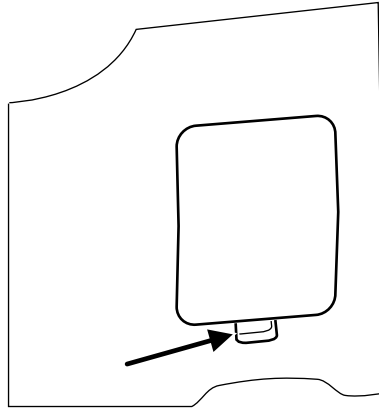

The fuses are coded as follows:

## Roadside Emergencies

Fuse/Relay Location	Fuse Amp Rating	Passenger Compartment Fuse Panel Description
1	—	Not used
2	—	Not used
3	15A*	Front and rear park lamps
4	10A*	Ignition switch
5	2A*	Powertrain Control Module (PCM relay), PATS module
6	15A*	Stop lamps
7	10A*	Instrument cluster, Power mirror switch, Radio
8	—	Not used
9	30A**	Power door locks
10	15A*	Heated mirrors, Rear defroster switch indicator
11	15A*	Moon roof
12	5A*	Radio
13	—	Not used
14	—	Not used
15	30A**	Power windows
16	15A*	Subwoofer
17	15A*	Low beams
18	10A*	4x4
19	—	Not used
20	15A*	Horn
21	10A*	Rear wiper motor, Rear wiper washer
22	10A*	Instrument cluster
23	—	Not used
24	20A*	Cigar lighter
25	20A*	Front wiper motor, Front wiper washer
26	5A*	Climate control system mode switch

## Roadside Emergencies

Fuse/Relay Location	Fuse Amp Rating	Passenger Compartment Fuse Panel Description
27	5A*	Traction (high voltage) Battery Control Module (TBCM), Injectors
28	10A*	Instrument cluster
29	10A*	Back-up lamps, Reverse park aid
30	—	Not used
31	—	Not used
32	—	Not used
33	15A*	Air bag module
34	5A*	Brake System Control Module (BSCM), Power Steering Control Module (PSCM)
35	5A*	4x4, Power point (110V AC), Heated seats

\* Mini fuse \*\* Cartridge fuse

### Power distribution box

The power distribution box is located in the engine compartment. The power distribution box contains high-current fuses that protect your vehicle's main electrical systems from overloads.



Always disconnect the low voltage (underhood) battery before servicing high current fuses.



To reduce risk of electrical shock, always replace the cover to the power distribution box before reconnecting the low voltage (underhood) battery or refilling fluid reservoirs.

If the low voltage (underhood) battery has been disconnected and reconnected, refer to the *Low voltage (underhood) battery* section of the *Maintenance and Specifications* chapter.

## Roadside Emergencies

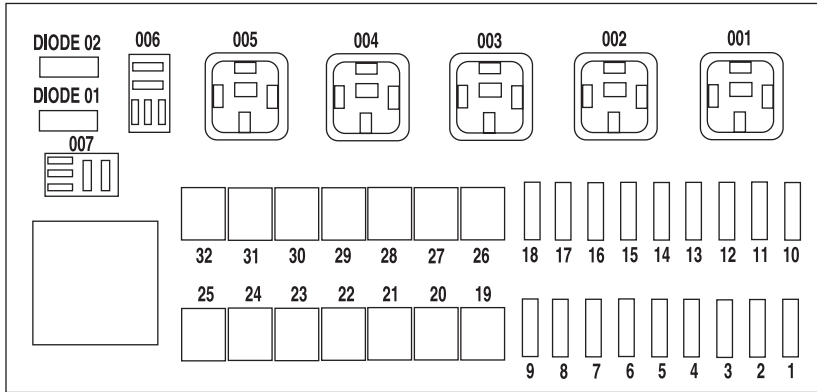

The fuses are coded as follows.

Fuse/Relay Location	Fuse Amp Rating	Power Distribution Box Description
1	5A*	Brake module
2	10A*	Climate control
3	5A*	Transaxle Control Module (TCM)
4	7.5A*	Traction (high voltage) Battery Control Module (TBCM), Powertrain Control Module (PCM)
5	5A*	Interlock
6	15A*	PCM power
7	15A*	Heated Exhaust Gas Oxygen (HEGO) sensors
8	10A*	TCM VPWR
9	20A*	Fuel pump
10	30A*	Bussed power feed to PDB fuses 1, 2, 3, 4
11	20A*	Foglamps
12	25A*	Exterior lighting
13	25A*	B+ lighting

## Roadside Emergencies

Fuse/Relay Location	Fuse Amp Rating	Power Distribution Box Description
14	30A*	Power point (110V AC)
15	20A*	Ignition main
16	15A*	A/C clutch
17	20A*	Power point
18	30A*	Injectors, COP (Coil-on-plug)
19	40A**	Climate control blower
20	40A**	Cooling fan #1
21	40A**	PCM power
22	40A**	SJB power (Passenger compartment fuse box) power #1
23	40A**	SJB (Passenger compartment fuse box) power #2
24	50A**	BSCM #1
25	50A**	Power Steering Control Module (PSCM) #1
26	50A**	TBCM (high voltage battery) cooling fans and jump start
27	40A**	Cooling fan #2
28	40A**	Rear defroster, Heated mirrors
29	20A**	Heated seats
30	40A**	SJB (Passenger compartment fuse box) power #3
31	50A**	BSCM #2
32	50A**	PSCM #2
001	Relay	Power sustain for PCM, TBCM and Transaxle Control Module (TCM)
002	Relay	PCM power
003	Relay	Injector
004	Relay	Auxiliary coolant pump
005	Relay	Motor/Electronic coolant pump
006	Relay	Foglamps

## Roadside Emergencies

Fuse/Relay Location	Fuse Amp Rating	Power Distribution Box Description
007	Relay	A/C clutch
Diode 01	—	A/C clutch
Diode 02	—	Not used

\* Mini fuse \*\*Cartridge fuse

### Auxiliary relay box

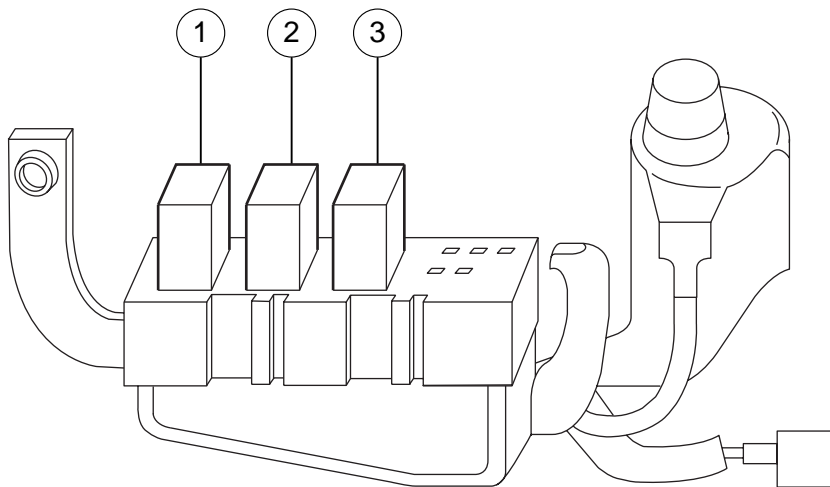

The relay box is located on the radiator support (left of the hood latch).

Fuse/Relay Location	Description
Relay 1	Driver side cooling fan
Relay 2	Passenger side cooling fan (low-speed)
Relay 3	Passenger side cooling fan (high-speed)

### CHANGING A FLAT TIRE

If you get a flat tire while driving:

- do not brake heavily.

232

2007 Escape Hybrid (ehv)  
 Owners Guide (post-2002-fmt)  
 USA (fus)



## Roadside Emergencies

- gradually decrease the vehicle's speed.
- hold the steering wheel firmly.
- slowly move to a safe place on the side of the road.

Your vehicle may be equipped with a conventional spare tire that is different in one or more of the following: type, brand, size, speed rating and tread design. If this is the case, this dissimilar spare tire is still rated for your vehicle loads (GAWR and GVWR). This temporary spare tire is not equipped with a Tire Pressure Monitor System (TPMS) sensor.



The use of tire sealants may damage your tires. The use of tire sealants may also damage your Tire Pressure Monitoring System and should not be used.



Refer to *Tire Pressure Monitoring System (TPMS)* in the *Tire, Wheels and Loading* chapter for important information. If the tire pressure monitor sensor becomes damaged, it will no longer function.

### Dissimilar spare tire/wheel information



Failure to follow these guidelines could result in an increased risk of loss of vehicle control, injury or death.

If you have a dissimilar spare tire/wheel, then it is intended for temporary use only. This means that if you need to use it, you should replace it as soon as possible with a road tire/wheel that is the same size and type as the road tires and wheels that were originally provided by Ford. If the dissimilar spare tire or wheel is damaged, it should be replaced rather than repaired.

A dissimilar spare tire/wheel is defined as a spare tire and/or wheel that is different in brand, size or appearance from the road tires and wheels and can be one of three types:

1. **T-type mini-spare:** This spare tire begins with the letter "T" for tire size and may have "Temporary Use Only" molded in the sidewall
2. **Full-size dissimilar spare with label on wheel:** This spare tire has a label on the wheel that states: "THIS TIRE AND WHEEL FOR TEMPORARY USE ONLY"

## Roadside Emergencies

When driving with one of the dissimilar spare tires listed above, **do not:**

- Exceed 50 mph (80 km/h)
- Load the vehicle beyond maximum vehicle load rating listed on the Safety Compliance Label
- Tow a trailer
- Use snow chains on the end of the vehicle with the dissimilar spare tire
- Use more than one dissimilar spare tire at a time
- Use commercial car washing equipment
- Try to repair the dissimilar spare tire

Use of one of the dissimilar spare tires listed above at any one wheel location can lead to impairment of the following:

- Handling, stability and braking performance
- Comfort and noise
- Ground clearance and parking at curbs
- Winter weather driving capability
- Wet weather driving capability

For vehicles equipped with 4WD, it is not recommended that the vehicle be operated in 4WD modes with a temporary emergency spare tire. If 4WD operation is necessary, do not operate above speeds of 10 mph (16 km/h) or for distances above 50 miles (80 km).

### 3. Full-size dissimilar spare without label on wheel

When driving with the full-size dissimilar spare tire/wheel, **do not:**

- Exceed 70 mph (113 km/h)
- Use more than one dissimilar spare tire/wheel at a time
- Use commercial car washing equipment
- Use snow chains on the end of the vehicle with the dissimilar spare tire/wheel

The usage of a full-size dissimilar spare tire/wheel can lead to impairment of the following:

- Handling, stability and braking performance
- Comfort and noise
- Ground clearance and parking at curbs

234

*2007 Escape Hybrid (ehv)  
Owners Guide (post-2002-fmt)  
USA (fus)*

## Roadside Emergencies

- Winter weather driving capability
- Wet weather driving capability
- All-Wheel driving capability (if applicable)
- Load leveling adjustment (if applicable)

When driving with the full-size dissimilar spare tire/wheel additional caution should be given to:

- Towing a trailer
- Driving vehicles equipped with a camper body
- Driving vehicles with a load on the cargo rack

Drive cautiously when using a full-size dissimilar spare tire/wheel and seek service as soon as possible.

### Tire change procedure

**Note:** The tire pressure monitoring system (TPMS) indicator light will illuminate when the spare is in use. To restore the full functionality of the TPMS system, all road wheels equipped with the tire pressure monitoring sensors must be mounted on the vehicle.

Have a flat tire serviced by an authorized dealer in order to prevent damage to the TPMS sensor, refer to *Tire Pressure Monitoring System (TPMS)* in the *Tires, Wheels, and Loading* chapter. Replace the spare tire with a road tire as soon as possible. During the repairing or replacing of the flat tire, have the authorized dealer inspect the TPMS sensor for damage.



When one of the front wheels is off the ground, the transmission alone will not prevent the vehicle from moving or slipping off the jack, even if the vehicle is in P (Park).



To help prevent the vehicle from moving when you change a tire, be sure the parking brake is set, then block (in both directions) the wheel that is diagonally opposite (other side and end of the vehicle) to the tire being changed.



If the vehicle slips off the jack, you or someone else could be seriously injured.

## Roadside Emergencies

1. Park on a level surface, activate hazard flashers and place gearshift lever in P (Park).
2. Set the parking brake and turn engine off.

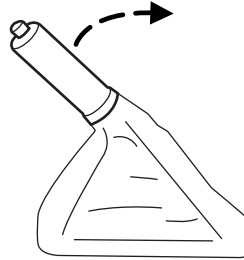

3. Block the diagonally opposite wheel.

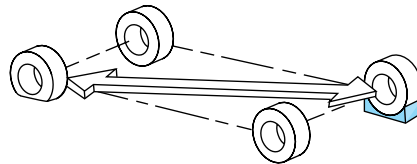

### **Removing the jack and tools**

The jack and tools are located in the right rear of the cargo area behind an access panel.

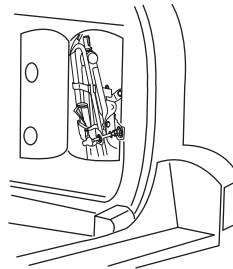

## Roadside Emergencies

To remove jack from vehicle:

1. Release the thumbscrew on the bracket.
2. Release the retention clip on the upper part of the jack bracket.
3. Dislodge the jack from the bracket and carefully guide jack down and out through trim opening, upper end out first.

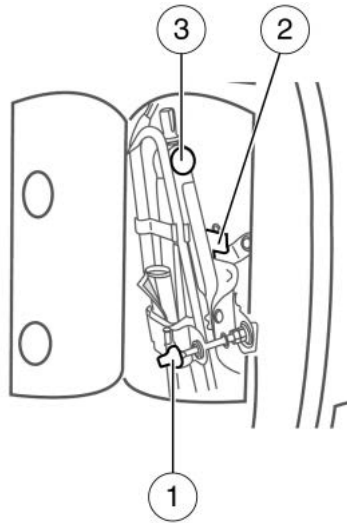

Remove the lug wrench from the jack in order to remove the spare tire from under the vehicle.

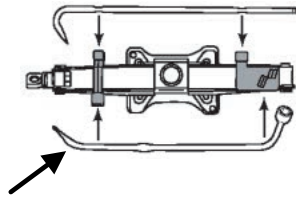

### **Removing the spare tire or spare tire and tether (if equipped)**

1. Insert the lug wrench through the access hole in the rear bumper.
2. Turn the handle counterclockwise and lower the spare tire until it can be slid rearward and the cable is slack.
3. Slide the retainer through the center of the wheel.

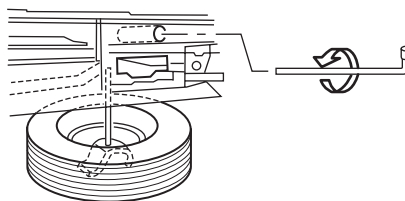

## Roadside Emergencies

**If equipped with a tether, perform the following additional steps:**

4. Lift the spare tire on end to access tether attachment (1).

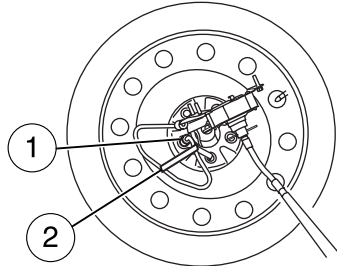

5. Use the lug wrench to remove the lug nut from the spare tire tether.

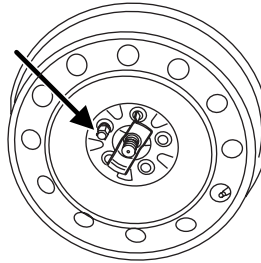

6. If not replacing the spare or flat tire to the underbody storage area, raise winch up into the installed position.

7. Use the attached VELCRO® strap (2) to tie the tether end to the winch actuator shaft (if equipped).

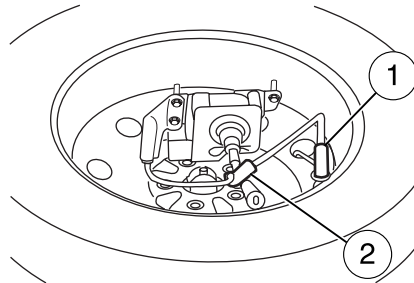

## Roadside Emergencies

### **Changing the flat tire**

8. Loosen each wheel lug nut one-half turn counterclockwise but do not remove them until the wheel is raised off the ground.

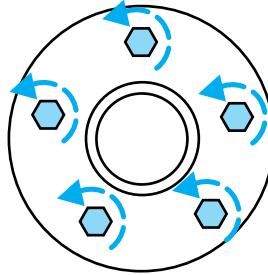

 Before placing the jack under the vehicle, NOTE the jack locations:

- **Front**

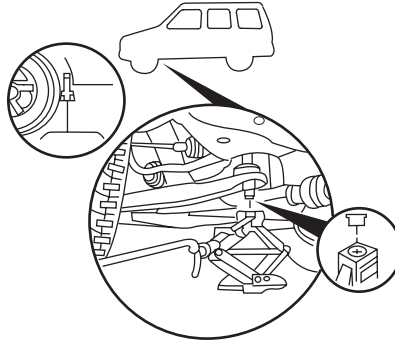

## Roadside Emergencies

- **Rear**

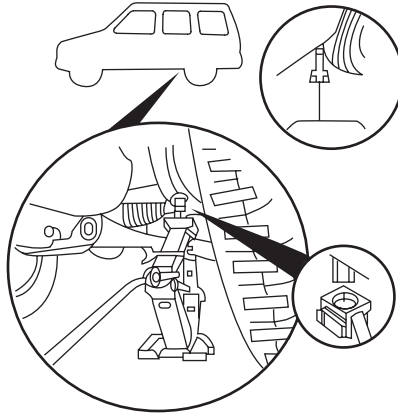

9. Lower the jack from its stored height to fit under the jacking notches. Position the jack according to the following guides and turn the jack handle clockwise until the tire is a maximum of 1 inch (25 mm) off the ground.

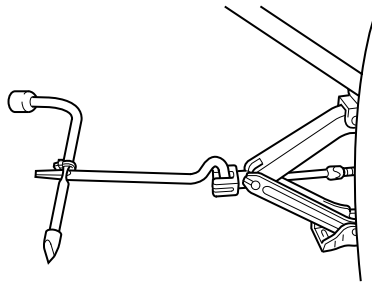

**Never use the differentials as a jacking point.**



To lessen the risk of personal injury, do not put any part of your body under the vehicle while changing a tire. Do not start the engine when your vehicle is on the jack. The jack is only meant for changing the tire.

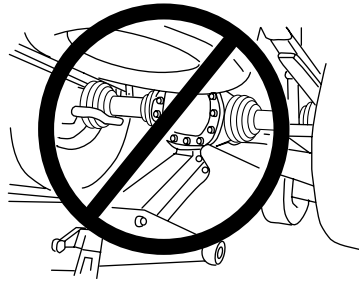

10. Remove the lug nuts with the lug nut wrench.

240

*2007 Escape Hybrid (ehv)  
Owners Guide (post-2002-fmt)  
USA (fus)*



## Roadside Emergencies

11. Replace the flat tire with the spare tire, making sure the valve stem is facing outward. Reinstall lug nuts until the wheel is snug against the hub. Do not fully tighten the lug nuts until the wheel has been lowered.

12. Lower the wheel by turning the jack handle counterclockwise.

13. Remove the jack and fully tighten the lug nuts in the order shown. Refer to *Wheel lug nut torque specifications* later in this chapter for the proper lug nut torque specification.

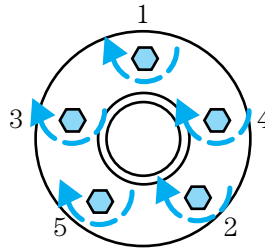

### Stowing the jack and tools

Reclip the tools onto the jack.

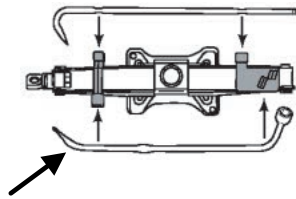

## Roadside Emergencies

Reinstall the jack and tools in the cargo area. To replace the jack in the vehicle,

- guide the jack bottom first in the trim opening and position in the bracket (3),
- secure the retention clip on the upper part of the jack (2), and
- close the thumbscrew (1).

Make sure the jack is fastened so it does not rattle when you drive.

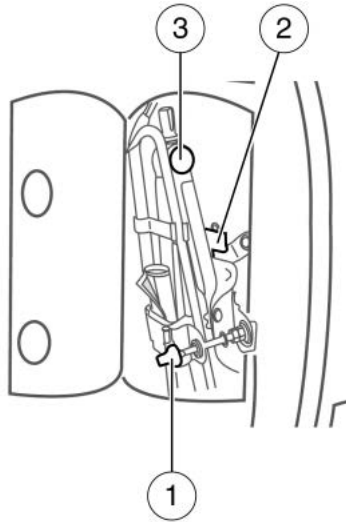

### Stowing the flat/spare tire

**Note:** Failure to follow spare tire stowage instructions may result in failure of cable or loss of spare tire.

**If you are stowing a tire that requires reattaching it to the vehicle with a tether, perform these steps first, then proceed with the steps following.**

1. Place tire on end with valve stem facing rearward, away from vehicle.
2. Place tether into bolt holes in wheel and attach lug nut using lug wrench.

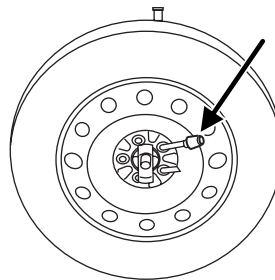

3. Lay the tire on the ground with the valve stem facing down. If your vehicle is equipped with aluminum wheels, remove the wheel ornament.

242

2007 Escape Hybrid (ehv)  
Owners Guide (post-2002-fmt)  
USA (fus)

## Roadside Emergencies

- Slide the wheel partially under the vehicle and install the retainer through the center of the wheel.
- Turn the jack handle clockwise until the tire is raised to its original position underneath the vehicle. The effort to turn the jack handle increases significantly as the tire contacts the frame. The spare tire carrier will ratchet when the tire is in the fully stowed position. The spare tire carrier has a built-in ratchet feature that will not allow you to overtighten. If the spare tire carrier ratchets with very little effort, take the vehicle to your authorized dealer for assistance at your earliest convenience. **If your vehicle is equipped with a trailer hitch, guide the tire with one hand; keep the rear of the tire tilted down until the tire clears the bumper.**
- Check that the tire lies flat against the frame assembly. Push against the tire to make sure it is tightly seated under the vehicle. Loosen and retighten, if necessary. Failure to properly stow the spare tire may result in failure of the winch cable and loss of the spare tire. **(Make sure that the tire does not contact the bumper.)**
- Repeat this tightness check procedure (every six months, per *scheduled maintenance information*), when servicing the spare tire pressure or at any time that the spare tire is disturbed through service of other components.

### WHEEL LUG NUT TORQUE SPECIFICATIONS

Retighten the lug nuts to the specified torque at 500 miles (800 km) after any wheel disturbance (tire rotation, changing a flat tire, wheel removal, etc.).

Bolt size	Wheel lug nut torque*	
	lb.ft.	N•m
M12 x 1.5	100	135

\* Torque specifications are for nut and bolt threads free of dirt and rust. Use only Ford recommended replacement fasteners.

 When a wheel is installed, always remove any corrosion, dirt or foreign materials present on the mounting surfaces of the wheel or the surface of the wheel hub, brake drum or brake disc that contacts the wheel. Ensure that any fasteners that attach the rotor to the hub are secured so they do not interfere with the mounting surfaces of the wheel. Installing wheels without correct metal-to-metal contact at the wheel mounting surfaces can cause the wheel nuts to loosen and the wheel to come off while the vehicle is in motion, resulting in loss of control.

## Roadside Emergencies

### JUMP STARTING (LOW VOLTAGE [UNDERHOOD] BATTERY ONLY)

Your vehicle has two separate jump starting procedures; the following procedure is for the low voltage (underhood) battery only. Refer to *Jump starting the high voltage battery* in this chapter for information on jump starting the high voltage battery.



The gases around the battery can explode if exposed to flames, sparks, or lit cigarettes. An explosion could result in injury or vehicle damage.



Batteries contain sulfuric acid which can burn skin, eyes and clothing, if contacted.

**Do not attempt to push-start your automatic transmission vehicle. Automatic transmissions do not have push-start capability. Attempting to push-start a vehicle with an automatic transmission may cause transmission damage.**

### Preparing your vehicle

If your low voltage (underhood) battery becomes disconnected or disabled for any reason, the vehicle controller must relearn the engine's operating characteristics in order to operate it at maximum efficiency. This relearning process occurs the first time the vehicle is driven after reconnecting the low voltage battery. If the learning procedure does not have time to complete during the drive, the engine will continue to operate for 3-5 seconds after you turn the ignition off to complete the relearning process. This is a normal condition and will not re-occur until the low voltage battery is disconnected again. The brake system must also be reset. Refer to *Low voltage (underhood) battery* in the *Maintenance and Specification* chapter for more information.

1. **Use only a 12-volt supply to start your vehicle.**
2. Do not disconnect the battery of the disabled vehicle as this could damage the vehicle's electrical system.
3. Park the booster vehicle close to the hood of the disabled vehicle making sure the two vehicles **do not** touch. Set the parking brake on both vehicles and stay clear of the engine cooling fan and other moving parts.
4. Check all battery terminals and remove any excessive corrosion before you attach the battery cables. Ensure that vent caps are tight and level.

244

2007 Escape Hybrid (ehv)  
Owners Guide (post-2002-fmt)  
USA (fus)

## Roadside Emergencies

5. Turn the heater fan on in both vehicles to protect any electrical surges. Turn all other accessories off.

### Connecting the jumper cables

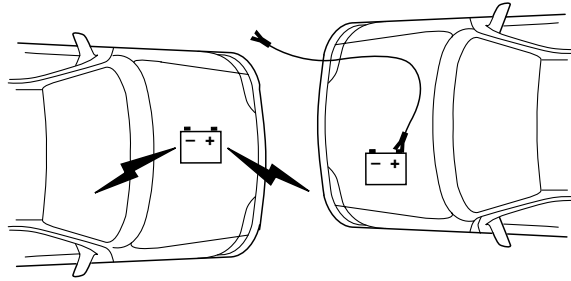

1. Connect the positive (+) jumper cable to the positive (+) terminal of the discharged battery.

**Note:** In the illustrations, *lightning bolts* are used to designate the assisting (boosting) battery.

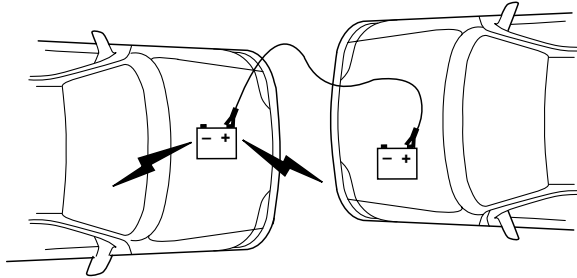

2. Connect the other end of the positive (+) cable to the positive (+) terminal of the assisting battery.

## Roadside Emergencies

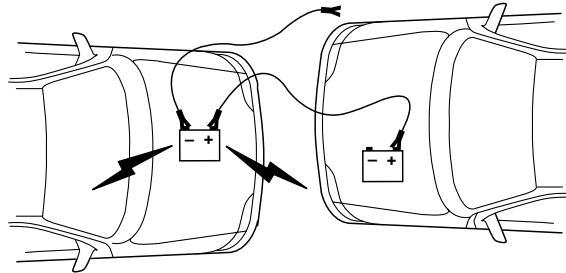

3. Connect the negative (-) cable to the negative (-) terminal of the assisting battery.

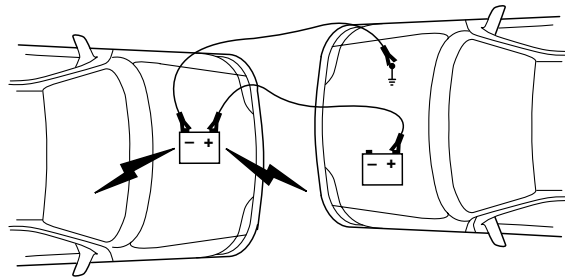

4. Make the final connection of the negative (-) cable to an exposed metal part of the stalled vehicle's engine, away from the battery and the carburetor/fuel injection system. **Do not** use fuel lines, engine rocker covers or the intake manifold as *grounding* points.



Do not connect the end of the second cable to the negative (-) terminal of the battery to be jumped. A spark may cause an explosion of the gases that surround the battery.

5. Ensure that the cables are clear of fan blades, belts, moving parts of both engines, or any fuel delivery system parts.

### Jump starting

1. Start the engine of the booster vehicle and run the engine at moderately increased speed.
2. Start the engine of the disabled vehicle.

246

2007 Escape Hybrid (ehv)  
Owners Guide (post-2002-fmt)  
USA (fus)

## Roadside Emergencies

3. Once the disabled vehicle has been started, run both engines for an additional three minutes before disconnecting the jumper cables.

### Removing the jumper cables

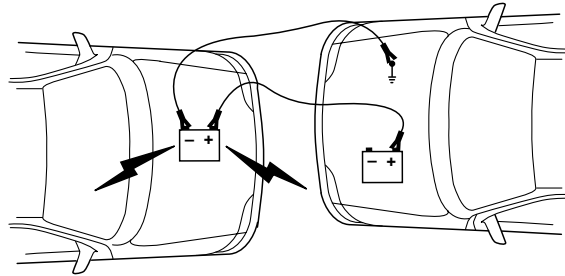

**Remove the jumper cables in the reverse order that they were connected.**

1. Remove the jumper cable from the *ground* metal surface.

**Note:** In the illustrations, *lightning bolts* are used to designate the assisting (boosting) battery.

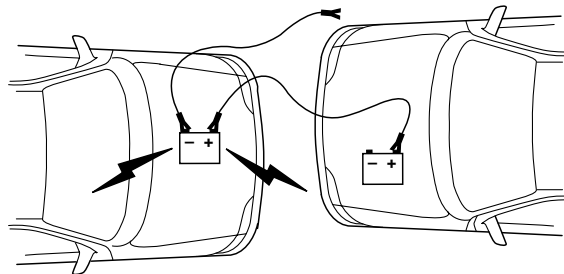

2. Remove the jumper cable on the negative (-) connection of the booster vehicle's battery.

## Roadside Emergencies

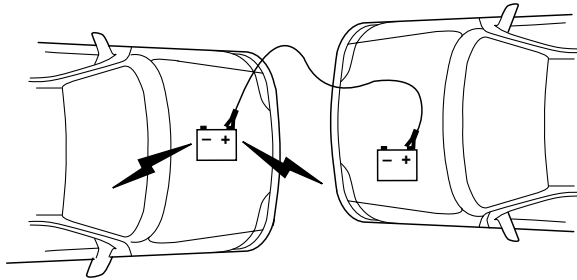

3. Remove the jumper cable from the positive (+) terminal of the booster vehicle's battery.

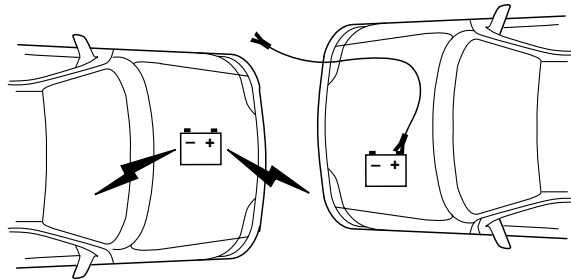

4. Remove the jumper cable from the positive (+) terminal of the disabled vehicle's battery.

After the disabled vehicle has been started and the jumper cables removed, allow it to idle for several minutes so the engine computer can *relearn* its idle conditions.

### JUMP STARTING THE HIGH VOLTAGE BATTERY

Your vehicle has two separate jump starting procedures; the following procedure is for the cargo area high voltage battery only. Refer to the *Jump starting your vehicle (Low voltage [underhood] battery only)* section in this chapter for information on jump starting the low voltage (underhood) battery.



The gases around the battery can explode if exposed to flames, sparks, or lit cigarettes. An explosion could result in injury or vehicle damage.



## Roadside Emergencies



The high voltage battery contains potassium hydroxide (a strong alkaline electrolyte) which can burn skin, eyes and clothing, if contacted.

**Do not attempt to push-start your vehicle. This vehicle does not have push-start capability.**

If you attempt to start your vehicle and the engine cranks but does not start, the high voltage battery may need to be jump started.

The Service Soon (yellow wrench) light in the instrument cluster may also be illuminated and the message center may display a message.

To jump start the high voltage battery, turn the ignition to OFF, open the access panel in the driver side foot well and press the jump start button momentarily. After pressing the button, you should wait eight minutes before attempting to start the engine, otherwise the high voltage battery may not receive sufficient charge to start the engine. The high voltage battery will use voltage from the low voltage (underhood) battery to charge itself.

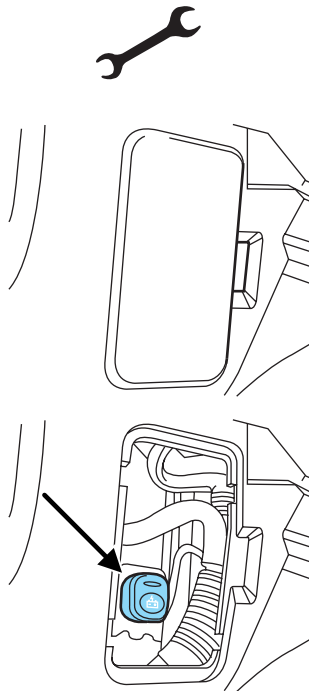

When the button is pressed, the indicator light on the button will illuminate. After eight minutes has passed, the indicator light will flash rapidly for two minutes. Turn the ignition to RUN. You may now attempt to start the engine. **If you attempt to start the engine before the eight minutes passes, the jump starting procedure will stop and will have to be restarted if the engine does not start.**

## Roadside Emergencies

If the engine still does not start after the first complete high voltage jump start, a second jump start procedure can be attempted after a two-minute period (indicated by the button light changing from a rapid flash to no illumination). This jump start procedure can only be done twice before the low voltage (underhood) battery becomes discharged and must also be jump started.

If the jump start button is pressed, but the indicator on the button flashes slowly, the low voltage (underhood) battery may not have enough energy to charge the high voltage battery. If this occurs, refer to the *Jump starting your vehicle (Low voltage [underhood] battery only)* section in this chapter for information on jump starting the low voltage (underhood) battery. You may perform another high voltage battery jump start by pressing the jump start button after having connected the jumper cables and starting the booster vehicle.

Once the engine is started, the jumper cables should be removed as described in the *Jump starting your vehicle (Low voltage [underhood] battery only)* section.

## Roadside Emergencies

### WRECKER TOWING

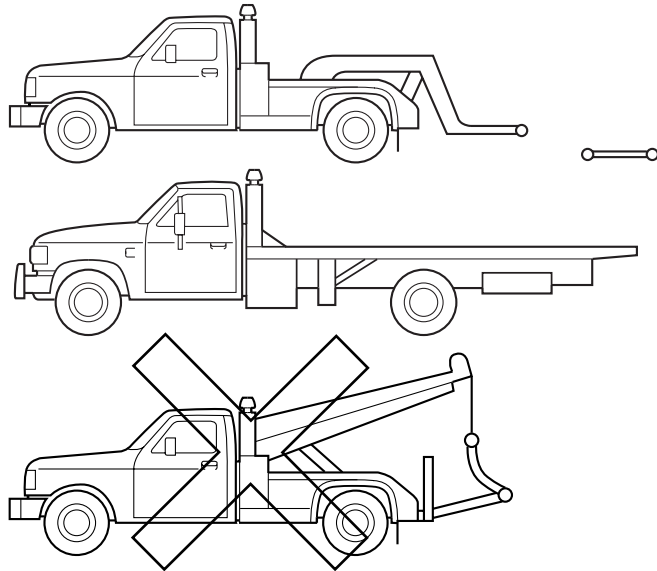

If you need to have your vehicle towed, contact a professional towing service or, if you are a member of a roadside assistance program, your roadside assistance service provider.

It is recommended that your vehicle be towed with a wheel lift and dollies or flatbed equipment. Do not tow with a slingbelt. Ford Motor Company has not approved a slingbelt towing procedure.

On FWD vehicles, if your vehicle is to be towed from the front, ensure proper wheel lift equipment is used to raise the front wheels off the ground. The rear wheels can be left on the ground when towed in this fashion.

If your vehicle is to be towed from the rear using wheel lift equipment, it is **required** that the front wheels (drive wheels) be placed on a dolly to prevent damage to the automatic transaxle.

On 4WD vehicles, it is **required** that your vehicle be towed with a wheel lift and dollies or flatbed equipment with all the wheels off the ground to prevent damage to the automatic transaxle, 4WD system or vehicle.

## Roadside Emergencies

**If the vehicle is towed by other means or incorrectly, vehicle damage may occur.**

In case of a roadside emergency with a disabled vehicle (without access to wheel dollies, car hauling trailer, or flatbed transport vehicle) your vehicle (regardless of transmission powertrain configuration) can be flat towed (all wheels on the ground) with the transmission placed in N (Neutral).

Ford Motor Company produces a towing manual for all authorized tow truck operators. Have your tow truck operator refer to this manual for proper hook-up and towing procedures for your vehicle.

## Customer Assistance

### GETTING THE SERVICES YOU NEED

#### At home

You must take your Ford vehicle to an authorized dealer for warranty repairs. While any authorized dealer handling your vehicle line will provide warranty service, we recommend you return to your selling authorized dealer who wants to ensure your continued satisfaction. Please note that certain warranty repairs require special training and/or equipment, so not all authorized dealers are authorized to perform all warranty repairs. This means that, depending on the warranty repair needed, you may have to take your vehicle to another authorized dealer. A reasonable time must be allowed to perform a repair after taking your vehicle to the authorized dealer. Repairs will be made using Ford or Motorcraft parts, or remanufactured or other parts that are authorized by Ford.

If you have questions or concerns, or are unsatisfied with the service you are receiving, follow these steps:

1. Contact your Sales Representative or Service Advisor at your selling/servicing authorized dealer.
2. If your inquiry or concern remains unresolved, contact the Sales Manager, Service Manager or Customer Relations Manager.
3. If you require assistance or clarification on Ford Motor Company policies or procedures, please contact the Ford Customer Relationship Center at 1-800-392-3673 (FORD).

#### Away from home

If you own a Ford or Mercury vehicle and are away from home when your vehicle needs service, or if you need more help than the authorized dealer could provide, after following the steps described above, contact the Ford Customer Relationship Center to find an authorized dealer to help you.

In the United States:

Ford Motor Company  
Customer Relationship Center  
P.O. Box 6248  
Dearborn, MI 48121  
1-800-392-3673 (FORD)  
(TDD for the hearing impaired: 1-800-232-5952)  
[www.customersaskford.com](http://www.customersaskford.com)

## Customer Assistance

In Canada:  
Customer Relationship Centre  
Ford Motor Company of Canada, Limited  
P.O. Box 2000  
Oakville, Ontario L6J 5E4  
1-800-565-3673 (FORD)  
www.ford.ca

If you own a Lincoln vehicle and are away from home when your vehicle needs service, or if you need more help than the authorized dealer could provide, after following the steps described above, contact the Ford Customer Relationship Center to find an authorized dealer to help you.

In the United States:  
Ford Motor Company  
Customer Relationship Center  
P.O. Box 6248  
Dearborn, MI 48121  
1-800-521-4140  
(TDD for the hearing impaired: 1-800-232-5952)  
www.customersaskford.com

In Canada:  
Lincoln Centre  
Ford Motor Company of Canada, Limited  
P.O. Box 2000  
Oakville, Ontario L6J 5E4  
1-800-387-9333  
www.lincolncanada.com

In order to help you service your Lincoln vehicle, please have the following information available when contacting the Lincoln Centre:

- Your telephone number (home and business)
- The name of the authorized dealer and the city where the authorized dealer is located
- The year and make of your vehicle
- The date of vehicle purchase
- The current odometer reading
- The vehicle identification number (VIN)

### **Additional Assistance**

If you still have a complaint involving a warranty dispute, you may wish to contact the Better Business Bureau (BBB) AUTO LINE program (U.S. only).

254

**2007 Escape Hybrid (ehv)**  
**Owners Guide (post-2002-fmt)**  
**USA (fus)**

## Customer Assistance

In some states (in the U.S.) you must directly notify Ford in writing before pursuing remedies under your state's warranty laws. Ford is also allowed a final repair attempt in some states.

In the United States, a warranty dispute must be submitted to the BBB AUTO LINE before taking action under the Magnuson-Moss Warranty Act, or to the extent allowed by state law, before pursuing replacement or repurchase remedies provided by certain state laws. This dispute handling procedure is not required prior to enforcing state created rights or other rights which are independent of the Magnuson-Moss Warranty Act or state replacement or repurchase laws.

### **IN CALIFORNIA (U.S. ONLY)**

California Civil Code Section 1793.2(d) requires that, if a manufacturer or its representative is unable to repair a motor vehicle to conform to the vehicle's applicable express warranty after a reasonable number of attempts, the manufacturer shall be required to either replace the vehicle with one substantially identical or repurchase the vehicle and reimburse the buyer in an amount equal to the actual price paid or payable by the consumer (less a reasonable allowance for consumer use). The consumer has the right to choose whether to receive a refund or replacement vehicle.

California Civil Code Section 1793.22(b) presumes that the manufacturer has had a reasonable number of attempts to conform the vehicle to its applicable express warranties if, within the first 18 months of ownership of a new vehicle or the first 18,000 miles (29,000 km), whichever occurs first:

1. Two or more repair attempts are made on the same non-conformity likely to cause death or serious bodily injury OR
2. Four or more repair attempts are made on the same nonconformity (a defect or condition that substantially impairs the use, value or safety of the vehicle) OR
3. The vehicle is out of service for repair of nonconformities for a total of more than 30 calendar days (not necessarily all at one time)

In the case of 1 or 2 above, the consumer must also notify the manufacturer of the need for the repair of the nonconformity at the following address:

Ford Motor Company  
16800 Executive Plaza Drive  
Mail Drop 3NE-B  
Dearborn, MI 48126

## Customer Assistance

### **THE BETTER BUSINESS BUREAU (BBB) AUTO LINE PROGRAM (U.S. ONLY)**

Your satisfaction is important to Ford Motor Company and to your dealer. Experience has shown that our customers have been very successful in achieving satisfaction by following the three-step procedure outlined on the front page of the Warranty Guide. However, if your warranty concern has not been resolved using the three-step procedure, you may be eligible to participate in the BBB AUTO LINE program.

The BBB AUTO LINE program consists of two parts – mediation and arbitration. Initially, the BBB will try to resolve your question or concern through mediation. Mediation is a process through which a representative of the BBB will contact the parties and explore options for settlement of your claim. If mediation is not successful, customers with eligible claims may participate in the BBB AUTO LINE arbitration process. An arbitration hearing will be scheduled so that you can present your case in an informal setting before an impartial person. The arbitrator will consider the testimony provided and make a decision after the hearing. You are not bound by the decision but may choose to accept it. If you choose to accept the BBB AUTO LINE decision then Ford must abide by the accepted decision as well. If the arbitrator has decided in your favor and you accept the decision, the BBB AUTO LINE program will contact you to ensure that Ford has complied with the decision in a timely manner. Disputes submitted to the BBB AUTO LINE program are usually decided within forty days after you file your claim with the BBB.

To file a claim with the BBB AUTO LINE, you will be asked for your name and address, information about your vehicle, information about your concerns and any steps you have already taken to try to resolve them.

You can get more information by calling BBB AUTO LINE at 1-800-955-5100, or writing to:

BBB AUTO LINE  
4200 Wilson Boulevard, Suite 800  
Arlington, Virginia 22203-1833

**Note:** Ford Motor Company reserves the right to change eligibility limitations, modify procedures, or to discontinue this process at any time without notice and without obligation.

### **UTILIZING THE MEDIATION/ARBITRATION PROGRAM (CANADA ONLY)**

For vehicles delivered to authorized Canadian dealers. In those cases where you continue to feel that the efforts by Ford of Canada and the

256

*2007 Escape Hybrid (ehv)*  
*Owners Guide (post-2002-fmt)*  
*USA (fus)*



## Customer Assistance

authorized dealer to resolve a factory-related vehicle service concern have been unsatisfactory, Ford of Canada participates in an impartial third party mediation/arbitration program administered by the Canadian Motor Vehicle Arbitration Plan (CAMVAP).

The CAMVAP program is a straight-forward and relatively speedy alternative to resolve a disagreement when all other efforts to produce a settlement have failed. This procedure is without cost to you and is designed to eliminate the need for lengthy and expensive legal proceedings.

In the CAMVAP program, impartial third-party arbitrators conduct hearings at mutually convenient times and places in an informal environment. These impartial arbitrators review the positions of the parties, make decisions and, when appropriate, render awards to resolve disputes. CAMVAP decisions are fast, fair, and final as the arbitrator's award is binding both to you and Ford of Canada.

CAMVAP services are available in all territories and provinces. For more information, without charge or obligation, call your CAMVAP Provincial Administrator directly at 1-800-207-0685.

### **FORD EXTENDED SERVICE PLAN**

You can get more protection for your new car or light truck by purchasing Ford Extended Service Plan (Ford ESP) coverage. It provides the following:

- Benefits during the warranty period depending on the plan you purchase (such as: reimbursement for rentals; coverage for certain maintenance and wear items).
- Protection against covered repair costs after your Bumper-to-Bumper Warranty expires.

You may purchase Ford ESP from any participating authorized dealer. There are several plans available in various time, distance and deductible combinations which can be tailored to fit your own driving needs. Ford ESP also offers reimbursement benefits for towing and rental coverage.

When you buy Ford ESP, you receive Peace-of-Mind protection throughout the United States and Canada, provided by a network of more than 4,600 participating authorized dealers.

If you did not take advantage of the Ford Extended Service Plan at the time of purchasing your vehicle, you may still be eligible. Since this information is subject to change, please ask your authorized dealer for complete details about Ford Extended Service Plan coverage options, or visit the Ford ESP website at [www.ford-esp.com](http://www.ford-esp.com).

### **GETTING ASSISTANCE OUTSIDE THE U.S. AND CANADA**

Before exporting your vehicle to a foreign country, contact the appropriate foreign embassy or consulate. These officials can inform you of local vehicle registration regulations and where to find unleaded fuel.

## Customer Assistance

If you cannot find unleaded fuel or can only get fuel with an anti-knock index lower than is recommended for your vehicle, contact a regional office or owner relations/customer relationship office.

The use of leaded fuel in your vehicle without proper conversion may damage the effectiveness of your emission control system and may cause engine knocking or serious engine damage. Ford Motor Company/Ford of Canada is not responsible for any damage caused by use of improper fuel. Using leaded fuel may also result in difficulty importing your vehicle back into the U.S.

If your vehicle must be serviced while you are traveling or living in Central America, the Caribbean, or the Middle East, contact the nearest authorized dealer. If the authorized dealer cannot help you, write or call:

FORD MOTOR COMPANY  
WORLDWIDE DIRECT MARKET OPERATIONS  
1555 Fairlane Drive  
Fairlane Business Park #3  
Allen Park, Michigan 48101  
U.S.A.  
Telephone: (313) 594-4857  
FAX: (313) 390-0804

If you are in another foreign country, contact the nearest authorized dealer. If the authorized dealer employees cannot help you, they can direct you to the nearest Ford affiliate office.

If you buy your vehicle in North America and then relocate outside of the U.S. or Canada, register your vehicle identification number (VIN) and new address with Ford Motor Company Worldwide Direct Market Operations.

**Customers in the U.S. should call 1-800-392-3673.**

### ORDERING ADDITIONAL OWNER'S LITERATURE

To order the publications in this portfolio, contact Helm, Incorporated at:

HELM, INCORPORATED  
P.O. Box 07150  
Detroit, Michigan 48207

Or call:

**For a free publication catalog, order toll free: 1-800-782-4356**

Monday-Friday 8:00 a.m. - 6:00 p.m. EST

Helm, Incorporated can also be reached by their website:  
[www.helminc.com](http://www.helminc.com).

258

*2007 Escape Hybrid (ehv)  
Owners Guide (post-2002-fmt)  
USA (fus)*

## Customer Assistance

*(Items in this catalog may be purchased by credit card, check or money order.)*

### **Obtaining a French owner's guide**

French Owner's Guides can be obtained from your authorized dealer or by writing to Ford Motor Company of Canada, Limited, Service Publications, P.O. Box 1580, Station B, Mississauga, Ontario L4Y 4G3.

### **REPORTING SAFETY DEFECTS (U.S. ONLY)**

If you believe that your vehicle has a defect which could cause a crash or could cause injury or death, you should immediately inform the National Highway Traffic Safety



Administration (NHTSA) in addition to notifying Ford Motor Company.

If NHTSA receives similar complaints, it may open an investigation, and if it finds that a safety defect exists in a group of vehicles, it may order a recall and remedy campaign. However, NHTSA cannot become involved in individual problems between you, your dealer, or Ford Motor Company.

To contact NHTSA, you may call the Vehicle Safety Hotline toll-free at 1-888-327-4236 (TTY: 1-800-424-9153); go to <http://www.safercar.gov>; or write to:

Administrator  
NHTSA  
400 Seventh Street, SW  
Washington, D.C. 20590

You can also obtain other information about motor vehicle safety from <http://www.safercar.gov>.

## Cleaning

### WASHING THE EXTERIOR

Wash your vehicle regularly with cool or lukewarm water and a neutral pH shampoo, such as Motorcraft Detail Wash (ZC-3-A), which is available from your authorized dealer.

- Never use strong household detergents or soap, such as dish washing or laundry liquid. These products can discolor and spot painted surfaces.
- Never wash a vehicle that is “hot to the touch” or during exposure to strong, direct sunlight.
- Always use a clean sponge or car wash mitt with plenty of water for best results.
- Dry the vehicle with a chamois or soft terry cloth towel in order to eliminate water spotting.
- It is especially important to wash the vehicle regularly during the winter months, as dirt and road salt are difficult to remove and cause damage to the vehicle.
- Immediately remove items such as gasoline, diesel fuel, bird droppings and insect deposits because they can cause damage to the vehicle’s paintwork and trim over time.
- Remove any exterior accessories, such as antennas, before entering a car wash.
- **Suntan lotions and insect repellents can damage any painted surface; if these substances come in contact with your vehicle, wash off as soon as possible.**
- **Use care when washing the vehicle to ensure water and soap are not directed into the high voltage battery vent, located near the driver side rear window.**

### Exterior chrome

- Wash the vehicle first, using cool or lukewarm water and a neutral pH shampoo, such as Motorcraft Detail Wash (ZC-3-A).
- Use Custom Brite Metal Cleaner (ZC-15), available from your authorized dealer. Apply the product as you would a wax to clean bumpers and other chrome parts; allow the cleaner to dry for a few minutes, then wipe off the haze with a clean, dry rag.
- **Never use abrasive materials such as steel wool or plastic pads as they can scratch the chrome surface.**

### WAXING

Applying Motorcraft Paint Sealant (ZC-45) to your vehicle every six months will assist in reducing minor scratches and paint damage.

260

*2007 Escape Hybrid (ehv)  
Owners Guide (post-2002-fmt)  
USA (fus)*

## Cleaning

- Wash the vehicle first.
- Do not use waxes that contain abrasives; use Motorcraft Premium Liquid Wax (ZC-53-A), which is available from your authorized dealer, or an equivalent quality product.
- Do not allow paint sealant to come in contact with any non-body (low-gloss black) colored trim, such as grained door handles, roof racks, bumpers, side moldings, mirror housings or the windshield cowl area. The paint sealant will “gray” or stain the parts over time.

### PAINT CHIPS

Your authorized dealer has touch-up paint and sprays to match your vehicle's color. Take your color code (printed on a sticker in the driver's door jamb) to your authorized dealer to ensure you get the correct color.

- Remove particles such as bird droppings, tree sap, insect deposits, tar spots, road salt and industrial fallout before repairing paint chips.
- Always read the instructions before using the products.

### ALUMINUM WHEELS AND WHEEL COVERS

Aluminum wheels and wheel covers are coated with a clearcoat paint finish. In order to maintain their shine:

- Clean weekly with Motorcraft Wheel and Tire Cleaner (ZC-37-A), which is available from your authorized dealer. Heavy dirt and brake dust accumulation may require agitation with a sponge. Rinse thoroughly with a strong stream of water.
- Never apply any cleaning chemical to hot or warm wheel rims or covers.
- Some automatic car washes may cause damage to the finish on your wheel rims or covers. Chemical-strength cleaners, or cleaning chemicals, in combination with brush agitation to remove brake dust and dirt, could wear away the clearcoat finish over time.
- Do not use hydrofluoric acid-based or high caustic-based wheel cleaners, steel wool, fuels or strong household detergent.
- To remove tar and grease, use Motorcraft Bug and Tar Remover (ZC-42), available from your authorized dealer.

### ENGINE

Engines are more efficient when they are clean because grease and dirt buildup keep the engine warmer than normal. When washing:

## Cleaning

- Take care when using a power washer to clean the engine. The high-pressure fluid could penetrate the sealed parts and cause damage.
- Do not spray a hot engine with cold water to avoid cracking the engine block or other engine components.
- Spray Motorcraft Engine Shampoo and Degreaser (ZC-20) on all parts that require cleaning and pressure rinse clean.

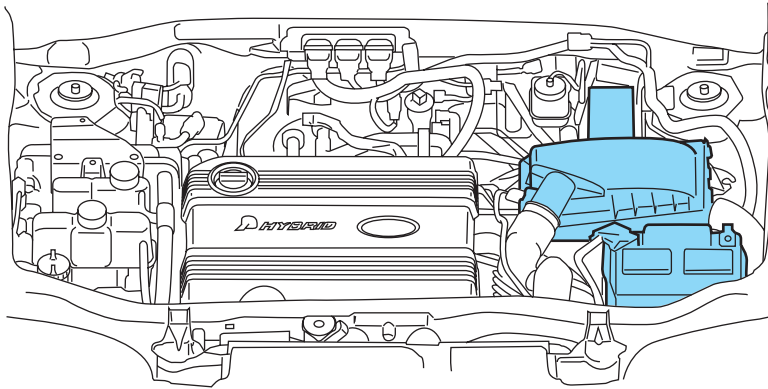

- Cover the highlighted areas to prevent water damage when cleaning the engine. **Note:** As with all transmissions, be especially careful as water entry into the vents can damage internal parts.
- Never wash or rinse the engine while it is running; water in the running engine may cause internal damage.

### PLASTIC (NON-PAINTED) EXTERIOR PARTS

Use only approved products to clean plastic parts. These products are available from your authorized dealer.

- For routine cleaning, use Motorcraft Detail Wash (ZC-3-A).
- If tar or grease spots are present, use Motorcraft Bug and Tar Remover (ZC-42).
- For plastic headlamp lenses, use Motorcraft Ultra Clear Spray Glass Cleaner (ZC-23).

### WINDOWS AND WIPER BLADES

The windshield, rear and side windows and the wiper blades should be cleaned regularly. If the wipers do not wipe properly, substances on the vehicle's glass or the wiper blades may be the cause. These may include hot wax treatments used by commercial car washes, water repellant coatings, tree sap, or other organic contamination; these contaminants may cause squeaking or chatter noise from the blades, and streaking and smearing of the windshield. To clean these items, follow these tips:

- The windshield, rear windows and side windows may be cleaned with a non-abrasive cleaner such as Motorcraft Ultra-Clear Spray Glass Cleaner (ZC-23), available from your authorized dealer.
- The wiper blades can be cleaned with isopropyl (rubbing) alcohol or Motorcraft Premium Windshield Washer Concentrate (ZC-32-A), available from your authorized dealer. This washer fluid contains special solution in addition to alcohol which helps to remove the hot wax deposited on the wiper blade and windshield from automated car wash facilities. Be sure to replace wiper blades when they appear worn or do not function properly.
- Do not use abrasives, as they may cause scratches.
- Do not use fuel, kerosene, or paint thinner to clean any parts.

If you cannot remove those streaks after cleaning with the glass cleaner or if the wipers chatter and move in a jerky motion, clean the outer surface of the windshield and the wiper blades using a sponge or soft cloth with a neutral detergent or mild-abrasive cleaning. After cleaning, rinse the windshield and wiper blades with clean water. The windshield is clean if beads do not form when you rinse the windshield with water.

**Do not use sharp objects, such as a razor blade, to clean the inside of the rear window or to remove decals, as it may cause damage to the rear window defroster's heated grid lines.**

### INSTRUMENT PANEL AND CLUSTER LENS

Clean the instrument panel with a damp cloth, then with a clean, dry cloth, or use Motorcraft Dash & Vinyl Cleaner (ZC-38-A).

- Avoid cleaners or polish that increase the gloss of the upper portion of the instrument panel. The dull finish in this area helps protect the driver from undesirable windshield reflection.



Do not use chemical solvents or strong detergents when cleaning the steering wheel or instrument panel to avoid contamination of the airbag system.

## Cleaning

- Be certain to wash or wipe your hands clean if you have been in contact with certain products such as insect repellent and suntan lotion in order to avoid possible damage to the interior painted surfaces.

### INTERIOR TRIM

- Clean the interior trim areas with a damp cloth, then with a clean, dry cloth; you may also use Motorcraft Dash & Vinyl Cleaner (ZC-38-A).
- Do not use household or glass cleaners as these may damage the finish.

### INTERIOR

For fabric, carpets, cloth seats, safety belts and seats equipped with side airbags:

- Remove dust and loose dirt with a vacuum cleaner.
- Remove light stains and soil with Motorcraft Professional Strength Carpet & Upholstery Cleaner (ZC-54).
- If grease or tar is present on the material, spot-clean the area first with Motorcraft Spot and Stain Remover (ZC-14).
- If a ring forms on the fabric after spot cleaning, clean the entire area immediately (but do not oversaturate) or the ring will set.
- Do not use household cleaning products or glass cleaners, which can stain and discolor the fabric and affect the flame retardant abilities of the seat materials.



Do not use cleaning solvents, bleach or dye on the vehicle's safety belts, as these actions may weaken the belt webbing.



Do not use chemical solvents or strong detergents when cleaning the seat-mounted side airbag (if equipped). Such products could contaminate the side airbag system and affect performance of the side airbag in a collision.

### LEATHER SEATS (IF EQUIPPED)

Your leather seating surfaces have a clear, protective coating over the leather.

- To clean, use a soft cloth with Motorcraft Deluxe Leather and Vinyl Cleaner (ZC-11-A). Dry the area with a soft cloth.

264

*2007 Escape Hybrid (ehv)  
Owners Guide (post-2002-fmt)  
USA (fus)*



## Cleaning

- To help maintain its resiliency and color, use the Motorcraft Deluxe Leather Care Kit (ZC-11-D), available from your authorized dealer.
- Do not use household cleaning products, alcohol solutions, solvents or cleaners intended for rubber, vinyl and plastics, or oil/petroleum-based leather conditioners. These products may cause premature wearing of the clear, protective coating.

**Note:** In some instances, color or dye transfer can occur when wet clothing comes in contact with leather upholstery. If this occurs, the leather should be cleaned immediately to avoid permanent staining.

### UNDERBODY

Flush the complete underside of your vehicle frequently. Keep body and door drain holes free from packed dirt.

### FORD AND LINCOLN MERCURY CAR CARE PRODUCTS

Your Ford or Lincoln Mercury authorized dealer has many quality products available to clean your vehicle and protect its finishes. These quality products have been specifically engineered to fulfill your automotive needs; they are custom designed to complement the style and appearance of your vehicle. Each product is made from high quality materials that meet or exceed rigid specifications. For best results, use the following products or products of equivalent quality:

Motorcraft Bug and Tar Remover (ZC-42)

Motorcraft Car Care Kit (ZC-26)

Motorcraft Car Wash (Canada only) (CXC-21)

Motorcraft Custom Bright Metal Cleaner (ZC-15)

Motorcraft Custom Clear Coat Polish (ZC-8-A)

Motorcraft Custom Vinyl Protectant (U.S. only) (ZC-40-A)

Motorcraft Dash and Vinyl Cleaner (ZC-38-A)

Motorcraft Deluxe Leather and Vinyl Cleaner (U.S. only) (ZC-11-A)

Motorcraft Detail Wash (ZC-3-A)

Motorcraft Dusting Cloth (ZC-24)

Motorcraft Engine Shampoo and Degreaser (U.S. only) (ZC-20)

Motorcraft Engine Shampoo (Canada only) (CXC-66-A)

Motorcraft One Step Wash and Wax Concentrate (ZC-6-A)

Motorcraft Paint Sealant (ZC-45)

## Cleaning

Motorcraft Premium Car Wash Concentrate (U.S. only) (ZC-17-B)  
Motorcraft Premium Glass Cleaner (Canada only) (CXC-100)  
Motorcraft Premium Liquid Wax (ZC-53-A)  
Motorcraft Premium Windshield Washer Concentrate (ZC-32-A)  
Motorcraft Professional Strength Carpet & Upholstery Cleaner (ZC-54)  
Motorcraft Spot and Stain Remover (U.S. only) (ZC-14)  
Motorcraft Tire Clean and Shine (ZC-28)  
Motorcraft Triple Clean (U.S. only) (ZC-13)  
Motorcraft Ultra-Clear Spray Glass Cleaner (ZC-23)  
Motorcraft Vinyl Cleaner (Canada only) (CXC-93)  
Motorcraft Wheel and Tire Cleaner (ZC-37-A)

## Maintenance and Specifications

### SERVICE RECOMMENDATIONS

To help you service your vehicle we provide *scheduled maintenance information* which makes tracking routine service easy.

If your vehicle requires professional service, your authorized dealer can provide the necessary parts and service. Check your *Warranty Guide/Owner Information Guide* to find out which parts and services are covered.

Use only recommended fuels, lubricants, fluids and service parts conforming to specifications. Motorcraft parts are designed and built to provide the best performance in your vehicle.

### PRECAUTIONS WHEN SERVICING YOUR VEHICLE

- Do not work on a hot engine.
- Make sure that nothing gets caught in moving parts.
- Do not work on a vehicle with the engine running in an enclosed space, unless you are sure you have enough ventilation.
- Keep all open flames and other lit material away from the battery and all fuel related parts.

### High Voltage Information



Exposure to high voltage may result in severe personal injury or death. High voltage components must be serviced by a trained service technician.

Your vehicle consists of various high voltage components and wiring. All of the high voltage power flows through specific wiring assemblies which are labeled as such and/or are covered with a solid orange convolute or orange stripe tape. Do not come in contact with these components.

The following are specific locations in the rear cargo area that consist of high voltage components and/or wiring.

## Maintenance and Specifications

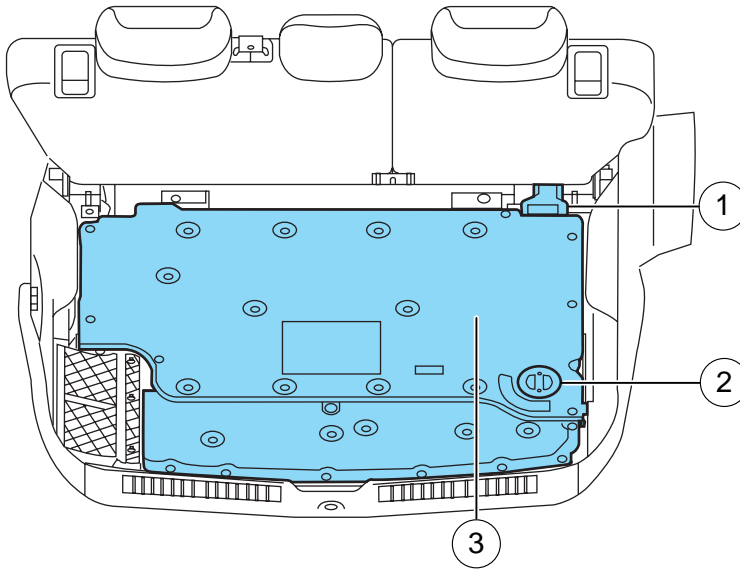

1. High voltage connector shield
2. Service Disconnect
3. High voltage battery case

### Working with the engine off

1. Set the parking brake and shift to P (Park).
2. Turn off the engine and remove the key.
3. Block the wheels.

### Working with the engine on

1. Set the parking brake and shift to P (Park).
2. Block the wheels.



To reduce the risk of vehicle damage and/or personal burn injuries do not start your engine with the air cleaner removed and do not remove it while the engine is running.

## Maintenance and Specifications

### OPENING THE HOOD

1. Inside the vehicle, pull the hood release handle located under the bottom of the instrument panel.

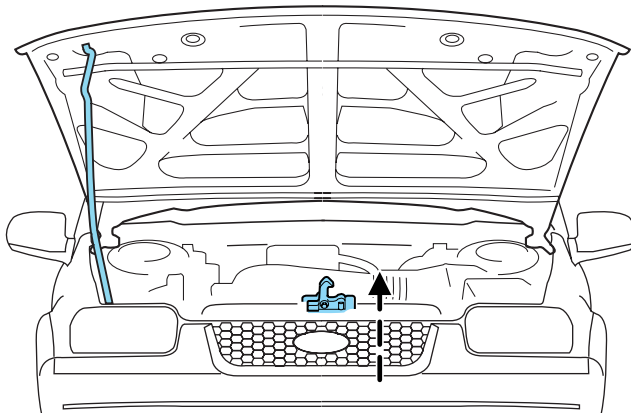
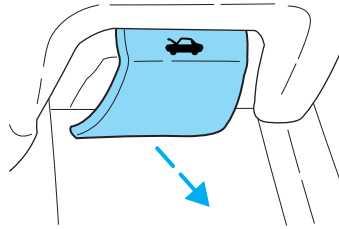

2. At the front of the vehicle, lift up on the auxiliary latch handle located in the center between the hood and the grille.
3. Lift the hood open and secure it with the prop rod.

## Maintenance and Specifications

### IDENTIFYING COMPONENTS IN THE ENGINE COMPARTMENT

#### 2.3L I4 engine

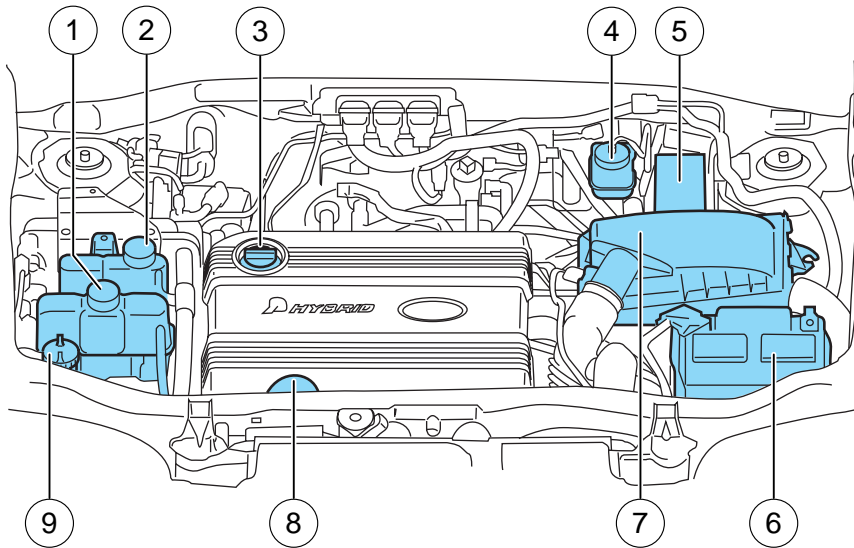

1. Engine coolant reservoir
2. Motor/Electronics (M/E) coolant reservoir
3. Engine oil filler cap
4. Brake fluid reservoir
5. Power distribution box
6. Low Voltage (underhood) battery
7. Engine air filter assembly
8. Engine oil dipstick
9. Windshield washer fluid reservoir

## Maintenance and Specifications

### WINDSHIELD WASHER FLUID

Add fluid to fill the reservoir if the level is low. In very cold weather, do not fill the reservoir completely.

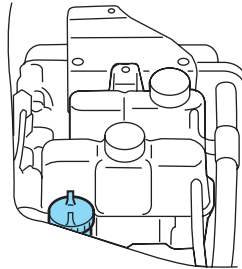

Only use a washer fluid that meets Ford specifications. Do not use any special washer fluid such as windshield water repellent type fluid or bug wash. They may cause squeaking, chatter noise, streaking and smearing. Refer to the *Maintenance product specifications and capacities* section in this chapter.

State or local regulations on volatile organic compounds may restrict the use of methanol, a common windshield washer antifreeze additive. Washer fluids containing non-methanol antifreeze agents should be used only if they provide cold weather protection without damaging the vehicle's paint finish, wiper blades or washer system.



If you operate your vehicle in temperatures below 40° F (4.5°C), use washer fluid with antifreeze protection. Failure to use washer fluid with antifreeze protection in cold weather could result in impaired windshield vision and increase the risk of injury or accident.

**Note:** Do not put washer fluid in the engine coolant reservoir. Washer fluid placed in the cooling system may harm engine and cooling system components.

### Checking and adding washer fluid for the liftgate

Washer fluid for the liftgate is supplied by the same reservoir as the windshield.

## Maintenance and Specifications

### CHANGING THE WIPER BLADES

1. Pull the wiper blade and arm away from the glass. Turn the blade at a right angle to the arm. Push the lock tab (A) to release the blade from the arm loop and pull the blade down toward the windshield to remove it from the arm.
2. Attach the new blade to the arm loop and pull it into place until a click is heard.

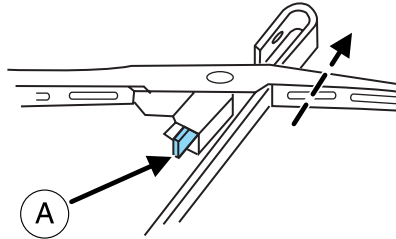

Replace wiper blades at least once per year for optimum performance.

Poor wiper quality can be improved by cleaning the wiper blades and the windshield, refer to *Windows and wiper blades* in the *Cleaning* chapter.

To prolong the life of the wiper blades, it is highly recommended to scrape off the ice on the windshield before turning on the wipers. The layer of ice has many sharp edges and can damage the micro edge of the wiper rubber element.

### ENGINE OIL

#### Checking the engine oil

Refer to the *scheduled maintenance information* for the appropriate intervals for checking the engine oil.

1. Make sure the vehicle is on level ground.
2. Turn the engine off and wait a few minutes for the oil to drain into the oil pan.
3. Set the parking brake and ensure the gearshift is securely latched in P (Park).
4. Open the hood. Protect yourself from engine heat.



## Maintenance and Specifications

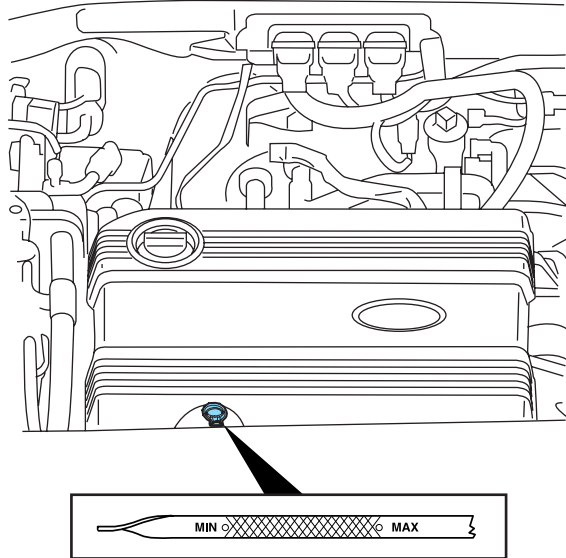

5. Locate and carefully remove the engine oil level indicator (dipstick).
6. Wipe the indicator clean. Insert the indicator fully, then remove it again.
  - If the oil level is within the MIN and MAX marks or the lower and upper holes, the oil level is acceptable. **DO NOT ADD OIL.**
  - If the oil level is below the MIN mark or the lower hole, engine **oil must be added** to raise the level within the normal operating range.
  - If required, add engine oil to the engine. Refer to *Adding engine oil* in this chapter.
  - **Do not overfill the engine with oil. Oil levels above the MAX mark or upper hole may cause engine damage.** If the engine is overfilled, some oil must be removed from the engine by an authorized dealer.
7. Put the indicator back in and ensure it is fully seated.

### Adding engine oil

1. Check the engine oil. For instructions, refer to *Checking the engine oil* in this chapter.

## Maintenance and Specifications

2. If the engine oil level is not within the normal range, add only certified engine oil of the recommended viscosity. Remove the engine oil filler cap and use a funnel to pour the engine oil into the opening.
3. Recheck the engine oil level. Make sure the oil level is not above the FULL mark on the engine oil level indicator (dipstick).
4. Install the indicator and ensure it is fully seated.
5. Fully install the engine oil filler cap by turning the filler cap clockwise 1/4 of a turn until it is seated.

**To avoid possible oil loss, DO NOT operate the vehicle with the engine oil level indicator and/or the engine oil filler cap removed.**

### Engine oil and filter recommendations

Look for this certification trademark.

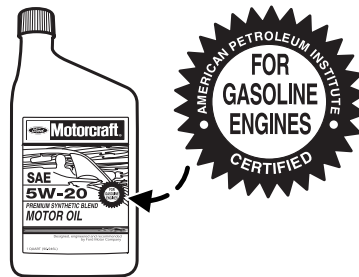

### Use SAE 5W-20 engine oil.

Only use oils “Certified For Gasoline Engines” by the American Petroleum Institute (API). An oil with this trademark symbol conforms to the current engine and emission system protection standards and fuel economy requirements of the International Lubricant Standardization and Approval Committee (ILSAC), comprised of U.S. and Japanese automobile manufacturers.

To protect your engine’s warranty use Motorcraft SAE 5W-20 or an equivalent SAE 5W-20 oil meeting Ford specification WSS-M2C930-A.

**SAE 5W-20 oil provides optimum fuel economy and durability performance meeting all requirements for your vehicle’s engine.**

Do not use supplemental engine oil additives, cleaners or other engine treatments. They are unnecessary and could lead to engine damage that is not covered by Ford warranty.

Change your engine oil and filter according to the appropriate schedule listed in *scheduled maintenance information*.

274

*2007 Escape Hybrid (ehv)*  
*Owners Guide (post-2002-fmt)*  
*USA (fus)*

## Maintenance and Specifications

When changing the oil filter on the 2.3L engine you must also replace the filter cap O-ring. The oil filter drain plug O-ring must also be replaced whenever the oil filter drain plug is removed. Reuse of the O-rings may cause engine oil leakage and may result in severe engine damage. The customer warranty may be void for any damage to the engine if the O-rings are not replaced.

Ford production and aftermarket (Motorcraft) oil filters are designed for added engine protection and long life. If a replacement oil filter is used that does not meet Ford material and design specifications, start-up engine noises or knock may be experienced. It is recommended you use the appropriate Motorcraft oil filter (or another brand meeting Ford specifications) for your engine application.

### LOW VOLTAGE (UNDERHOOD) BATTERY

Your vehicle is equipped with a Motorcraft maintenance-free battery which normally does not require additional water during its life of service.

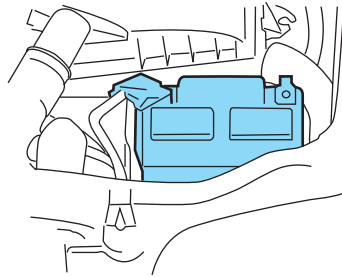

### **If your battery has a cover/shield, make sure it is reinstalled after the battery has been cleaned or replaced.**

For longer, trouble-free operation, keep the top of the battery clean and dry. Also, make certain the battery cables are always tightly fastened to the battery terminals.

If you see any corrosion on the battery or terminals, remove the cables from the terminals and clean with a wire brush. You can neutralize the acid with a solution of baking soda and water.

**Note: Electrical or electronic accessories or components added to the vehicle by the dealer or the owner (e.g. spot lights, electric winch, etc.) may adversely affect vehicle performance and durability.**



Batteries normally produce explosive gases which can cause personal injury. Therefore, do not allow flames, sparks or lighted substances to come near the battery. When working near the battery, always shield your face and protect your eyes. Always provide proper ventilation.

## Maintenance and Specifications

 When lifting a plastic-cased battery, excessive pressure on the end walls could cause acid to flow through the vent caps, resulting in personal injury and/or damage to the vehicle or battery. Lift the battery with a battery carrier or with your hands on opposite corners.

 Keep batteries out of reach of children. Batteries contain sulfuric acid. Avoid contact with skin, eyes or clothing. Shield your eyes when working near the battery to protect against possible splashing of acid solution. In case of acid contact with skin or eyes, flush immediately with water for a minimum of 15 minutes and get prompt medical attention. If acid is swallowed, call a physician immediately.

 Battery posts, terminals and related accessories contain lead and lead compounds. **Wash hands after handling.**

If the battery is disconnected, the Regenerative Braking System will need to relearn the initial brake pedal position. After reconnecting the battery, slowly depress and release the brake pedal one time.

Because your vehicle's engine is electronically controlled by a computer, some control conditions are maintained by power from the battery. When the battery is disconnected or a new battery is installed, the engine must relearn its idle and fuel trim strategy for optimum driveability and performance. To begin this process:

1. With the vehicle at a complete stop, set the parking brake.
2. Put the gearshift in P (Park), turn off all accessories and start the engine.
3. Run the engine until it reaches normal operating temperature.
4. Allow the engine to idle for at least one minute.
5. Turn the A/C on and allow the engine to idle for at least one minute.
6. Drive the vehicle to complete the relearning process.
  - The vehicle may need to be driven 10 miles (16 km) or more to relearn the idle and fuel trim strategy.
  - **If you do not allow the engine to relearn its idle trim, the idle quality of your vehicle may be adversely affected until the idle trim is eventually relearned.**

If the battery has been disconnected or a new battery has been installed, the clock and the preset radio stations must be reset once the battery is reconnected.

276

## Maintenance and Specifications

- Always dispose of automotive batteries in a responsible manner. Follow your local authorized standards for disposal. Call your local authorized recycling center to find out more about recycling automotive batteries.

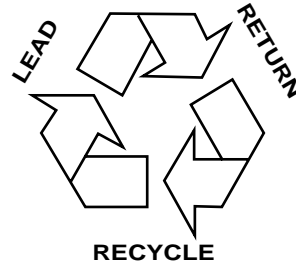

### Low and high voltage battery – storage

Your vehicle must be started and run for a minimum of 10 minutes once a month in order to maintain the high voltage battery charge. This will maintain the high voltage battery but it is not enough to maintain the low voltage (underhood) battery and additional low voltage (underhood) battery charging may be required after 60 days.

If your vehicle is to be stored for 30 days or longer, the low voltage (underhood) battery negative terminal must be disconnected. Failure to do this could damage your vehicle's batteries.

### ENGINE COOLANT AND MOTOR/ELECTRONICS COOLANT

Your vehicle is equipped with two separate coolant systems. One is for engine cooling and the other is for various electric motors and other components that are specific to the hybrid operating systems.

## Maintenance and Specifications

### Checking engine coolant

The concentration and level of engine coolant should be checked at the intervals listed in *scheduled maintenance information*. The coolant concentration should be maintained at 50/50 coolant and distilled water, which equates to a freeze point of  $-34^{\circ}\text{F}$  ( $-36^{\circ}\text{C}$ ). Coolant concentration testing is possible with a hydrometer or antifreeze tester (such as the Rotunda Battery and Antifreeze Tester, 014-R1060). The level of coolant should be maintained at the "FULL COLD" level or within the "COLD FILL RANGE" in the coolant reservoir. If the level falls below, add coolant per the instructions in the *Adding engine coolant* section. When the engine is cold, check the level of engine coolant in the reservoir.

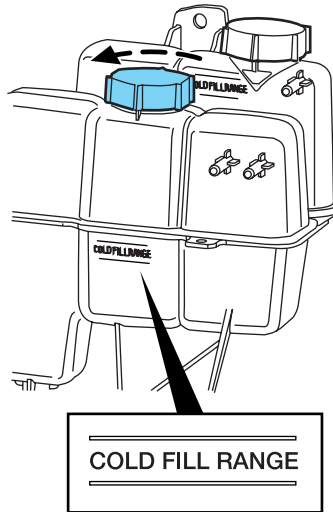

## Maintenance and Specifications

### Checking motor/electronics (M/E) coolant

The M/E coolant reservoir is located behind the engine coolant reservoir. Refer to the following engine coolant sections for all information, instructions and warnings related to cooling systems. The two systems use the same coolant and operate similarly, with the Motor and Electronics system generally operating at a lower temperature and pressure. The fluid levels in both reservoirs need to be maintained. When the engine is cold, check the level of M/E coolant in the reservoir.

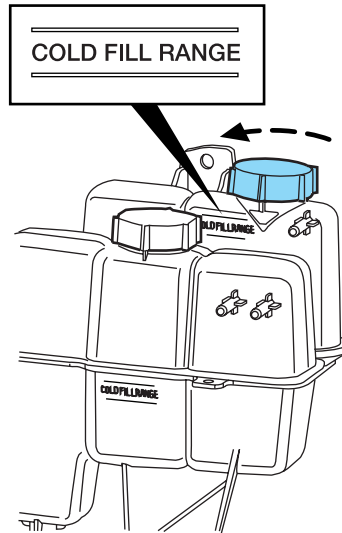

### Factory fill and coolant specifications

Your vehicle was factory-filled with a 50/50 engine coolant and water concentration. If the concentration of coolant falls below 40% or above 60%, the engine parts could become damaged or not work properly. **A 50–50 mixture of coolant and water provides the following:**

- **Freeze protection down to -34°F (-36°C).**
- **Boiling protection up to 265°F (129°C).**
- **Protection against rust and other forms of corrosion.**
- **Enables calibrated gauges to work properly.**

### Common instructions for cooling systems

- The engine coolant should be at the “FULL COLD” level or within the “COLD FILL RANGE” as listed on the engine coolant reservoir (depending upon application).
- Refer to the *scheduled maintenance information* for service interval schedules.
- Be sure to read and understand *Precautions when servicing your vehicle* in this chapter.

## Maintenance and Specifications

If the engine coolant has not been checked at the recommended interval, the engine coolant reservoir may become low or empty. If the reservoir is low or empty, add engine coolant to the reservoir. Refer to *Adding engine coolant* in this chapter.

**Note:** Automotive fluids are not interchangeable; do not use engine coolant, antifreeze or windshield washer fluid outside of its specified function and vehicle location.

### Adding engine coolant

When adding coolant, make sure it is a 50/50 mixture of engine coolant and distilled water. Add the mixture to the coolant reservoir, **when the engine is cool**, until the appropriate fill level is obtained.



Do not add engine coolant when the engine is hot. Steam and scalding liquids released from a hot cooling system can burn you badly. Also, you can be burned if you spill coolant on hot engine parts.



Do not put engine coolant in the windshield washer fluid container. If sprayed on the windshield, engine coolant could make it difficult to see through the windshield.

- **Add Motorcraft Premium Gold Engine Coolant or equivalent meeting Ford specification WSS-M97B51-A1.** Refer to *Maintenance product specifications and capacities* in this chapter.

**Note:** Use of Motorcraft Cooling System Stop Leak Pellets or an equivalent product meeting Ford specification WSS-M99B37-B6, may darken the color of Motorcraft Premium Gold Engine Coolant from yellow to golden tan.

- **Do not add/mix an orange-colored, extended life coolant such as Motorcraft Specialty Orange Engine Coolant, meeting Ford specification WSS-M97B44-D, with the factory-filled coolant.** Mixing Motorcraft Specialty Orange Engine Coolant or any orange-colored extended life product with your factory filled coolant can result in degraded corrosion protection.
- A large amount of water without engine coolant may be added, in case of emergency, to reach a vehicle service location. In this instance, the cooling system must be drained and refilled with a 50/50 mixture of engine coolant and distilled water as soon as possible. Water alone (without engine coolant) can cause engine damage from corrosion, overheating or freezing.



## Maintenance and Specifications

- **Do not use alcohol, methanol, brine or any engine coolants mixed with alcohol or methanol antifreeze (coolant).** Alcohol and other liquids can cause engine damage from overheating or freezing.
- **Do not add extra inhibitors or additives to the coolant.** These can be harmful and compromise the corrosion protection of the engine coolant.

For vehicles with overflow coolant systems with a non-pressurized cap on the coolant recovery system, add coolant to the coolant recovery reservoir when the engine is cool. Add the proper mixture of coolant and water to the “FULL COLD” level. For all other vehicles which have a coolant degas system with a pressurized cap, or if it is necessary to remove the coolant pressure relief cap on the radiator of a vehicle with an overflow system, follow these steps to add engine coolant.



To reduce the risk of personal injury, make sure the engine is cool before unscrewing the coolant pressure relief cap. The cooling system is under pressure; steam and hot liquid can come out forcefully when the cap is loosened slightly.

1. Before you begin, turn the engine off and let it cool.
2. When the engine is cool, wrap a thick cloth around the coolant pressure relief cap on the coolant reservoir (a translucent plastic bottle). Slowly turn cap counterclockwise (left) until pressure begins to release.
3. Step back while the pressure releases.
4. When you are sure that all the pressure has been released, use the cloth to turn it counterclockwise and remove the cap.
5. Fill the coolant reservoir slowly with the proper coolant mixture (see above), to within the “COLD FILL RANGE” or the “FULL COLD” level on the reservoir. If you removed the radiator cap in an overflow system, fill the radiator until the coolant is visible and radiator is almost full.
6. Replace the cap. Turn until tightly installed. (Cap must be tightly installed to prevent coolant loss.)

After any coolant has been added, check the coolant concentration (refer to *Checking engine coolant*). If the concentration is not 50/50 (protection to  $-34^{\circ}\text{F}/-36^{\circ}\text{C}$ ), drain some coolant and adjust the concentration. It may take several drains and additions to obtain a 50/50 coolant concentration.

Whenever coolant has been added, the coolant level in the coolant reservoir should be checked the next few times you drive the vehicle. If

## Maintenance and Specifications

necessary, add enough 50/50 concentration of engine coolant and distilled water to bring the liquid level to the proper level.

If you have to add more than 1.0 quart (1.0 liter) of engine coolant per month, have your authorized dealer check the engine cooling system. Your cooling system may have a leak. Operating an engine with a low level of coolant can result in engine overheating and possible engine damage.

### Recycled engine coolant

Ford Motor Company does NOT recommend the use of recycled engine coolant in vehicles originally equipped with Motorcraft Premium Gold Engine Coolant since a Ford-approved recycling process is not yet available.



Used engine coolant should be disposed of in an appropriate manner. Follow your community's regulations and standards for recycling and disposing of automotive fluids.

### Coolant refill capacity

To find out how much fluid your vehicle's cooling system can hold, refer to *Maintenance product specifications and capacities* in this chapter.

Fill your engine coolant reservoir as outlined in *Adding engine coolant* in this section.

### Severe climates

If you drive in extremely cold climates (less than  $-34^{\circ}\text{F}$  [ $-36^{\circ}\text{C}$  ]):

- **It may be necessary to increase the coolant concentration above 50%.**
- **NEVER increase the coolant concentration above 60%.**
- **Increased engine coolant concentrations above 60% will decrease the overheat protection characteristics of the engine coolant and may cause engine damage.**
- **Refer to the chart on the coolant container to ensure the coolant concentration in your vehicle will provide adequate freeze protection at the temperatures in which you drive in the winter months.**

If you drive in extremely hot climates:

- **It is still necessary to maintain the coolant concentration above 40%.**

282

2007 Escape Hybrid (ehv)  
Owners Guide (post-2002-fmt)  
USA (fus)

## Maintenance and Specifications

- **NEVER decrease the coolant concentration below 40%.**
- **Decreased engine coolant concentrations below 40% will decrease the corrosion protection characteristics of the engine coolant and may cause engine damage.**
- **Decreased engine coolant concentrations below 40% will decrease the freeze protection characteristics of the engine coolant and may cause engine damage.**
- **Refer to the chart on the coolant container to ensure the coolant concentration in your vehicle will provide adequate protection at the temperatures in which you drive.**

Vehicles driven year-round in non-extreme climates should use a 50/50 mixture of engine coolant and distilled water for optimum cooling system and engine protection.

### FUEL FILTER

For fuel filter replacement, see your authorized dealer. Refer to *scheduled maintenance information* for the appropriate intervals for changing the fuel filter.

**Replace the fuel filter with an authorized Motorcraft part. The customer warranty may be void for any damage to the fuel system if an authorized Motorcraft fuel filter is not used.**

### WHAT YOU SHOULD KNOW ABOUT AUTOMOTIVE FUELS

#### Important safety precautions



Do not overfill the fuel tank. The pressure in an overfilled tank may cause leakage and lead to fuel spray and fire.



The fuel system may be under pressure. If the fuel filler cap is venting vapor or if you hear a hissing sound, wait until it stops before completely removing the fuel filler cap. Otherwise, fuel may spray out and injure you or others.



If you do not use the proper fuel filler cap, excessive vacuum in the fuel tank may damage the fuel system or cause the fuel cap to disengage in a collision, which may result in possible personal injury.

## Maintenance and Specifications



Automotive fuels can cause serious injury or death if misused or mishandled.



Gasoline may contain benzene, which is a cancer-causing agent.

Observe the following guidelines when handling automotive fuel:

- Extinguish all smoking materials and any open flames before refueling your vehicle.
- Always turn off the vehicle before refueling.
- Automotive fuels can be harmful or fatal if swallowed. Fuel such as gasoline is highly toxic and if swallowed can cause death or permanent injury. If fuel is swallowed, call a physician immediately, even if no symptoms are immediately apparent. The toxic effects of fuel may not be visible for hours.
- Avoid inhaling fuel vapors. Inhaling too much fuel vapor of any kind can lead to eye and respiratory tract irritation. In severe cases, excessive or prolonged breathing of fuel vapor can cause serious illness and permanent injury.
- Avoid getting fuel liquid in your eyes. If fuel is splashed in the eyes, remove contact lenses (if worn), flush with water for 15 minutes and seek medical attention. Failure to seek proper medical attention could lead to permanent injury.
- Fuels can also be harmful if absorbed through the skin. If fuel is splashed on the skin and/or clothing, promptly remove contaminated clothing and wash skin thoroughly with soap and water. Repeated or prolonged skin contact with fuel liquid or vapor causes skin irritation.
- Be particularly careful if you are taking “Antabuse” or other forms of disulfiram for the treatment of alcoholism. Breathing gasoline vapors, or skin contact could cause an adverse reaction. In sensitive individuals, serious personal injury or sickness may result. If fuel is splashed on the skin, promptly wash skin thoroughly with soap and water. Consult a physician immediately if you experience an adverse reaction.



## Maintenance and Specifications

 When refueling always shut the engine off and never allow sparks or open flames near the filler neck. Never smoke while refueling. Fuel vapor is extremely hazardous under certain conditions. Care should be taken to avoid inhaling excess fumes.

 The flow of fuel through a fuel pump nozzle can produce static electricity, which can cause a fire if fuel is pumped into an ungrounded fuel container.

### Refueling

 Fuel vapor burns violently and a fuel fire can cause severe injuries. To help avoid injuries to you and others:

- Read and follow all the instructions on the pump island;
- Turn off your engine when you are refueling;
- Do not smoke if you are near fuel or refueling your vehicle;
- Keep sparks, flames and smoking materials away from fuel;
- Stay outside your vehicle and do not leave the fuel pump unattended when refueling your vehicle — this is against the law in some places;
- Keep children away from the fuel pump; never let children pump fuel.

Use the following guidelines to avoid electrostatic charge build-up when filling an ungrounded fuel container:

- Place approved fuel container on the ground.
- DO NOT fill a fuel container while it is in the vehicle (including the cargo area).
- Keep the fuel pump nozzle in contact with the fuel container while filling.
- DO NOT use a device that would hold the fuel pump handle in the fill position.

### Fuel Filler Cap

Your fuel tank filler cap has an indexed design with a 1/4 turn on/off feature.

When fueling your vehicle:

1. Turn the engine/ignition switch to the off position.

## Maintenance and Specifications

2. Carefully turn the filler cap counterclockwise until it spins off.
3. To install the cap, align the lugs on the cap with the threads on the filler pipe.
4. Turn the filler cap clockwise until it clicks at least once.

After refueling, if the “CHECK FUEL CAP” indicator comes on and stays on when you start the engine, the fuel filler cap may not be properly installed. Turn off the engine, remove the fuel filler cap, align the cap properly and reinstall it securely. The “CHECK FUEL CAP” indicator should turn off after three driving cycles with the fuel filler cap properly installed. A driving cycle consists of a cold engine start-up followed by mixed city/highway driving.

**If you must replace the fuel filler cap, replace it with a fuel filler cap that is designed for your vehicle. The customer warranty may be void for any damage to the fuel tank or fuel system if the correct genuine Ford or Motorcraft fuel filler cap is not used.**



The fuel system may be under pressure. Remove fuel filler cap slowly. Otherwise, fuel may spray out and injure you or others.



If you do not use the proper fuel filler cap, excessive vacuum in the fuel tank may damage the fuel system or cause the fuel cap to disengage in a collision, which may result in possible personal injury.

FORD RECOMMENDS BP



### Choosing the right fuel

Use only UNLEADED fuel or UNLEADED fuel blended with a maximum of 10% ethyl alcohol. Your vehicle was not designed to run on E85 fuels that are blended with a maximum of 85% ethyl alcohol. The use of leaded fuel is prohibited by law and could damage your vehicle. Do not use fuel containing methanol. It can damage critical fuel system components.

286

*2007 Escape Hybrid (ehv)  
Owners Guide (post-2002-fmt)  
USA (fus)*

## Maintenance and Specifications

Your vehicle was not designed to use fuel or fuel additives with metallic compounds, including manganese-based additives. Studies indicate that these additives can cause your vehicle's emission control system to deteriorate more rapidly. In Canada, premium grade fuel generally contains more metallic additives than regular grade fuel. We recommend using regular grade fuel. In Canada, many fuels contain metallic additives, but fuels free of such additives may be available; check with your local fuel dealer.

Repairs to correct the effects of using a fuel for which your vehicle was not designed may not be covered by your warranty.

### Octane recommendations

Your vehicle is designed to use "Regular" unleaded gasoline with pump (R+M)/2 octane rating of 87.

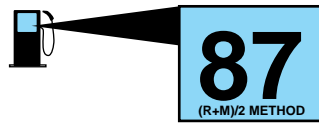

We do not recommend the use of gasolines labeled as "Regular" that are sold with octane ratings of 86 or lower in high altitude areas.

Do not be concerned if your engine sometimes knocks lightly. However, if it knocks heavily under most driving conditions while you are using fuel with the recommended octane rating, see your authorized dealer to prevent any engine damage.

### Fuel quality

If you are experiencing starting, rough idle or hesitation driveability problems, try a different brand of unleaded gasoline. "Premium" unleaded gasoline is not recommended for vehicles designed to use "Regular" unleaded gasoline because it may cause these problems to become more pronounced. If the problems persist, see your authorized dealer.

Do not add aftermarket fuel additive products to your fuel tank. It should not be necessary to add any aftermarket products to your fuel tank if you continue to use high quality fuel of the recommended octane rating. These products have not been approved for your engine and could cause damage to the fuel system. Repairs to correct the effects of using an aftermarket product in your fuel may not be covered by your warranty.

Many of the world's automakers approved the World-wide Fuel Charter that recommends gasoline specifications to provide improved performance and emission control system protection for your vehicle. Gasolines that meet the World-wide Fuel Charter should be used when available. Ask your fuel supplier about gasolines that meet the World-wide Fuel Charter.

## Maintenance and Specifications

### Cleaner air

Ford endorses the use of reformulated “cleaner-burning” gasolines to improve air quality.

### Running out of fuel

Avoid running out of fuel because this situation may have an adverse effect on powertrain components.

If you have run out of fuel:

- You may need to cycle the ignition from off to on several times after refueling, to allow the fuel system to pump the fuel from the tank to the engine.
- The  indicator may come on. For more information on the “check engine” or the “service engine soon” indicator, refer to *Warning lights and chimes* in the *Instrument Cluster* chapter.

## ESSENTIALS OF GOOD FUEL ECONOMY

### Measuring techniques

Your best source of information about actual fuel economy is you, the driver. You must gather information as accurately and consistently as possible. Fuel expense, frequency of fill-ups or fuel gauge readings are NOT accurate as a measure of fuel economy. We do not recommend taking fuel economy measurements during the first 1,000 miles (1,600 km) of driving (engine break-in period). You will get a more accurate measurement after 2,000 miles-3,000 miles (3,000 km–5,000 km).

### Filling the tank

When the fuel gauge indicates empty, there is still a small reserve of fuel in the fuel system. When refueling your vehicle after the fuel gauge indicates empty, you might not be able to refuel the full amount of the advertised capacity of the fuel tank due to the empty reserve still present in the tank. The amount of usable fuel in the empty reserve varies and should not be relied upon to increase driving range.

For consistent results when filling the fuel tank:

- Turn the engine/ignition switch to the off position prior to refueling, an error in the reading will result if the engine is left running.
- Allow no more than two automatic click-offs when filling.
- Always use fuel with the recommended octane rating.
- Use a known quality gasoline, preferably a national brand.

288

*2007 Escape Hybrid (ehv)*  
*Owners Guide (post-2002-fmt)*  
*USA (fus)*



## Maintenance and Specifications

Your results will be most accurate if your filling method is consistent.

### Calculating fuel economy

1. Fill the fuel tank completely and record the initial odometer reading (in miles or kilometers).
2. Each time you fill the tank, record the amount of fuel added (in gallons or liters).
3. After at least three to five tank fill-ups, fill the fuel tank and record the current odometer reading.
4. Subtract your initial odometer reading from the current odometer reading.
5. Follow one of the simple calculations in order to determine fuel economy:

Calculation 1: **Divide total miles traveled by total gallons used.**

Calculation 2: **Multiply liters used by 100, then divide by total kilometers traveled.**

Keep a record for at least one month and record the type of driving (city or highway). This will provide an accurate estimate of the vehicle's fuel economy under current driving conditions. Additionally, keeping records during summer and winter will show how temperature impacts fuel economy. In general, lower temperatures give lower fuel economy.

### Driving style — good driving and fuel economy habits

Since it is able to operate in electric mode and to collect braking energy, your hybrid vehicle will get better fuel economy in city driving than on the highway. This is contrary to conventional vehicles. However, many of the same actions that improve fuel economy in a conventional vehicle will also improve fuel economy in this vehicle.

Give consideration to the lists that follow and you may be able to change a number of variables and improve your fuel economy.

#### **Habits**

- Avoid aggressive driving. Quick acceleration and deceleration decrease fuel economy.
- Drive at a smooth, constant speed. Excessive variation in pedal input causes more operating mode changes and reduces efficiency.
- Drive at reasonable speeds. Traveling at 60 mph [96 km/h] uses approximately 20% less fuel than traveling at 70 mph [112 km/h].

## Maintenance and Specifications

- Minimize A/C and defroster usage. Selecting MAX A/C, defrost, or defrost/floor mode on the climate control system will force the engine to run continuously and reduce fuel economy.
- Minimize temperature extremes when the vehicle is parked, for example by storing in a garage to avoid extreme cold in winter and extreme sun loads in summer. The high voltage battery operates more efficiently in moderate temperatures.
- Combine errands. Your vehicle is more fuel efficient when the engine is warm. Driving to your farthest destination first will warm the engine more quickly and may improve fuel economy for the rest of the trip.

### **Maintenance**

- Keep tires properly inflated and use only recommended size.
- Keep wheels properly aligned.
- Use recommended engine oil. Refer to *Lubricant specifications* in this chapter.
- Perform all regularly scheduled maintenance items. Follow the recommended maintenance schedule and owner maintenance checks found in *scheduled maintenance information*.

### **Conditions**

- Heavily loading a vehicle or towing a trailer may reduce fuel economy at any speed.
- Carrying unnecessary weight may reduce fuel economy (approximately 1 mpg [0.4 km/L] is lost for every 300 lb [136 kg] of weight carried).
- Adding certain accessories to your vehicle (for example bug deflectors, rollbars/light bars, running boards, ski/luggage racks, flags) may reduce fuel economy.
- Using fuel blended with alcohol may lower fuel economy.
- Driving on flat terrain offers improved fuel economy as compared to driving on hilly terrain.
- Close windows for high speed driving.

### **EPA window sticker**

Every new vehicle should have the EPA window sticker. Contact your authorized dealer if the window sticker is not supplied with your vehicle. The EPA window sticker should be your guide for the fuel economy comparisons with other vehicles.

It is important to note the box in the lower left corner of the window sticker. These numbers represent the Range of MPG (L/100 km)

290

**2007 Escape Hybrid (ehv)**  
**Owners Guide (post-2002-fmt)**  
**USA (fus)**

## Maintenance and Specifications

expected on the vehicle under optimum conditions. Your fuel economy may vary depending upon the method of operation and conditions.

### EMISSION CONTROL SYSTEM

Your vehicle is equipped with various emission control components and a catalytic converter which will enable your vehicle to comply with applicable exhaust emission standards. To make sure that the catalytic converter and other emission control components continue to work properly:

- Use only the specified fuel listed.
- Avoid running out of fuel.
- Do not turn off the ignition while your vehicle is moving, especially at high speeds.
- Have the items listed in *scheduled maintenance information* performed according to the specified schedule.

The scheduled maintenance items listed in *scheduled maintenance information* are essential to the life and performance of your vehicle and to its emissions system.

If other than Ford, Motorcraft or Ford-authorized parts are used for maintenance replacements or for service of components affecting emission control, such non-Ford parts should be equivalent to genuine Ford Motor Company parts in performance and durability.

 Do not park, idle, or drive your vehicle in dry grass or other dry ground cover. The emission system heats up the engine compartment and exhaust system, which can start a fire.

Illumination of the  indicator, charging system warning light or the temperature warning light, fluid leaks, strange odors, smoke or loss of engine power could indicate that the emission control system is not working properly.

 Exhaust leaks may result in entry of harmful and potentially lethal fumes into the passenger compartment.



Do not make any unauthorized changes to your vehicle or engine. By law, vehicle owners and anyone who manufactures, repairs, services, sells, leases, trades vehicles, or supervises a fleet of vehicles are not permitted to intentionally remove an emission control device or prevent

## Maintenance and Specifications

it from working. Information about your vehicle's emission system is on the Vehicle Emission Control Information Decal located on or near the engine. This decal identifies engine displacement and gives some tune up specifications.

Please consult your *Warranty Guide* for complete emission warranty information.

### On board diagnostics (OBD-II)



Your vehicle is equipped with a computer that monitors the engine's emission control system. This system is commonly known as the On Board Diagnostics System (OBD-II). This OBD-II system protects the environment by ensuring that your vehicle continues to meet government emission standards. The OBD-II system also assists your authorized dealer in properly servicing your vehicle. When the  indicator illuminates, the OBD-II system has detected a malfunction. Temporary malfunctions may cause the  indicator to illuminate. Examples are:

1. The vehicle has run out of fuel—the engine may misfire or run poorly.
2. Poor fuel quality or water in the fuel.
3. The fuel cap may not have been securely tightened. See *Fuel filler cap* in this chapter.

These temporary malfunctions can be corrected by filling the fuel tank with good quality fuel and/or properly tightening the fuel cap. After three driving cycles without these or any other temporary malfunctions present, the  indicator should turn off—A driving cycle consists of a cold engine startup followed by mixed city/highway driving. No additional vehicle service is required.

If the  indicator remains on, have your vehicle serviced at the first available opportunity.

### Readiness for Inspection/Maintenance (I/M) testing

In some localities, it may be a legal requirement to pass an I/M test of the on-board diagnostics system. If the  indicator is on, refer to the description in the *Warning lights and chimes* section of the *Instrument Cluster* chapter. Your vehicle may not pass the I/M test with the  indicator on.

If the vehicle's powertrain system or its battery has just been serviced, the on-board diagnostics system is reset to a "not ready for I/M test"

## Maintenance and Specifications

condition. To ready the on-board diagnostics system for I/M testing, a minimum of 30 minutes of city and highway driving is necessary as described below:

- First, at least 10 minutes of driving on an expressway or highway.
- Next, at least 20 minutes driving in stop-and-go, city-type traffic with at least four idle periods.

Allow the vehicle to sit for at least eight hours without starting the engine. Then, start the engine and complete the above driving cycle. The engine must warm up to its normal operating temperature. Once started, do not turn off the engine until the above driving cycle is complete.

### BRAKE FLUID

The fluid level will drop slowly as the brakes wear, and will rise when the brake components are replaced.

Check fluid levels with the ignition in the RUN position. Fluid levels between the “MIN” and “MAX” lines are within the normal operating range; there is no need to add fluid.

If the fluid levels are outside of the normal operating range the performance of your brake system could be compromised; seek service from your authorized dealer immediately.

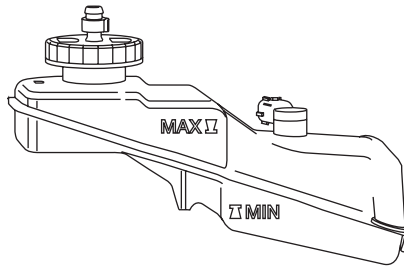

### Brake pad replacement information

The Regenerative Braking System checks the integrity of the brake system at times when the vehicle is parked. This is done by developing brake pressure for short periods of time. In order to change the brake pads, it is necessary to enter the Pad Service Mode. This will prevent brake pressure from being applied.

To enter the Pad Service Mode, perform the following with the vehicle stationary:

1. Place the vehicle in Park and turn ignition to the ON position.
2. Apply the brake pedal.
3. Turn the ignition OFF, then ON three times and then release the brake pedal. The total time elapsed for the three ignition cycles and brake release must be less than 3 seconds.

## Maintenance and Specifications

The brake warning lamp will:

- flash as stored hydraulic pressure is released.
- remain illuminated once the pressure is completely released.
- flash if the brake is applied.

To exit the Pad Service Mode:

1. Apply the brake pedal and turn the ignition OFF then ON. This will cause brake pressure to be developed within the brake system. Once brake pressure is developed, the brake warning light will turn off.
2. The Pad Service Mode will also be exited if the gear shift lever is moved from the (P) Park position, the vehicle is moved (wheels rotate) or the ignition is turned OFF.

**Note:** The brake system on this vehicle can only be bled at a authorized dealer.

### TRANSMISSION FLUID

#### Checking electronically controlled continuously variable transmission (eCVT)

Refer to your *scheduled maintenance information* chapter for scheduled intervals for fluid checks and changes. Your transaxle does not consume fluid. It is designed to be filled for life. However, the fluid level should be checked if you notice some sign of fluid leakage.

**Automatic transmission fluid expands when warmed. To obtain an accurate fluid check, drive the vehicle until it is warmed up (approximately 20 miles [30 km]). If your vehicle has been operated for an extended period at high speeds, in city traffic during hot weather or pulling a trailer, the vehicle should be turned off for about 30 minutes to allow fluid to cool before checking.**

1. Drive the vehicle 20 miles (30 km) or until it reaches normal operating temperature.
2. Park the vehicle on a level surface and engage the parking brake.

## Maintenance and Specifications

3. With the parking brake engaged and your foot on the brake pedal, turn the key to the ACCESSORY position but do not start the engine. Turn the wheel to the left to gain access to the check plug.

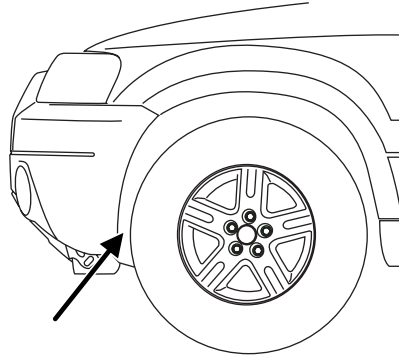

4. Latch the gearshift lever in P (Park) and make sure that the engine is OFF by placing the ignition in the Lock position.

5. Using the hole in the splash shield, remove the check plug from the side of the transmission.

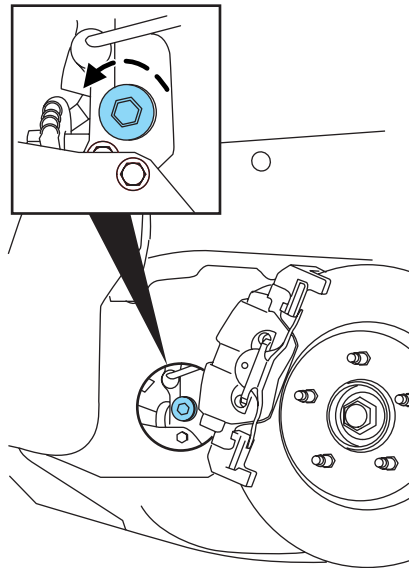

## Maintenance and Specifications

If this is the first check of the transmission fluid, it may be necessary to remove the perforated section of the splash shield (as indicated on the splash shield).

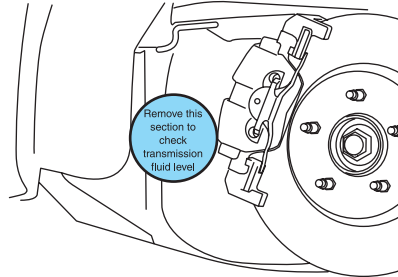

6. Be sure the engine has been stopped for at least 3 minutes before performing the fluid level check.
7. The fluid level should be within 1/4 inch (6 mm) of the plug threads.
8. Replace the check plug.

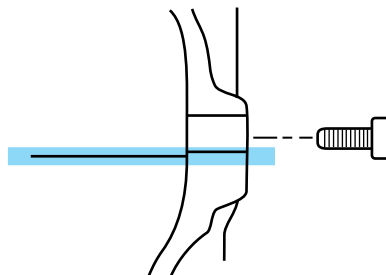

### **Adjusting eCVT fluid levels**

Before adding any fluid, make sure the correct type is used. The type of fluid used is indicated in the *Maintenance product specifications and capacities* section in this chapter.

### **Use of a non-approved fluid may cause internal transaxle component damage.**

If the fluid level is low, add fluid through the check port until the level is correct and fluid begins to run out of the transmission. If an overfill occurs, excess fluid should be removed by allowing the fluid to run out of the check port.

### **A serious overfill condition of transmission fluid may cause damage.**

Do not use supplemental transmission fluid additives, treatments or cleaning agents. The use of these materials may affect transmission operation and result in damage to internal transmission components.



## Maintenance and Specifications

### AIR FILTER

Refer to *scheduled maintenance information* for the appropriate intervals for changing the air filter element.

When changing the air filter element, use only the Motorcraft air filter element listed. Refer to *Motorcraft part numbers* in this chapter.

 To reduce the risk of vehicle damage and/or personal burn injuries do not start your engine with the air cleaner removed and do not remove it while the engine is running.

### Changing the air filter element

1. Release the clamps that secure the air filter housing cover.
2. Carefully separate the two halves of the air filter housing.

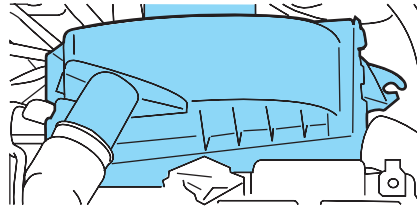

3. Remove the air filter element from the air filter housing.
4. Wipe the air filter housing and cover clean to remove any dirt or debris and to ensure good sealing.
5. Install a new air filter element. Be careful not to crimp the filter element edges between the air filter housing and cover. This could cause filter damage and allow unfiltered air to enter the engine if not properly seated.

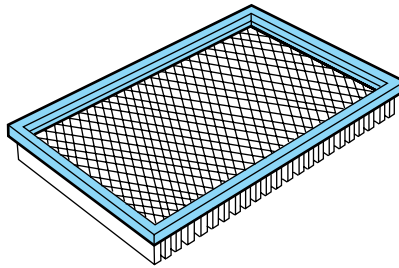

6. Replace the air filter housing cover and secure the clamps.

**Note:** Failure to use the correct air filter element may result in severe engine damage. The customer warranty may be voided for any damage to the engine if the correct air filter element is not used.

## Maintenance and Specifications

### HIGH VOLTAGE BATTERY COOLING FILTER (REAR A/C) MAINTENANCE

The high voltage battery has a dedicated A/C cooling system which includes an air filter.

Refer to the *scheduled maintenance information* for the appropriate intervals for air filter.

When changing the air filter element, use only the Motorcraft air filter element listed. Refer to *Motorcraft part numbers* in this chapter.

#### Changing the high voltage battery air filter element

1. Remove access panel located in the rear cargo area on the driver's side trim panel to expose the filter cover.

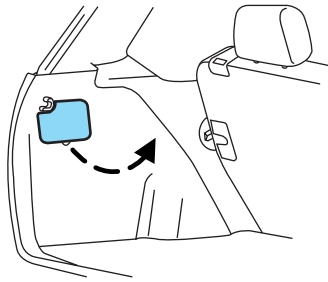

2. Push the tabs (located on each side of filter cover) while pulling gently to remove filter cover.

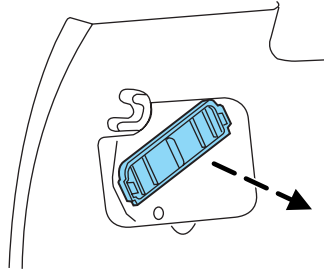

3. Install new filter and filter cover (note arrows indicating top side).

4. Re-install the access panel into the trim panel.

## Maintenance and Specifications

### MOTORCRAFT PART NUMBERS

Component	2.3L I4 engine
Oil filter	FL-2017-B <sup>1</sup>
PCV valve	<sup>2</sup>
Spark plugs	<sup>3</sup>
Engine air filter element	FA-1772 <sup>4</sup>
Rear A/C (high voltage battery cooling) air filter element	FP-51
Fuel filter	FG-800-A
Low voltage (underhood) battery	BXT-96R

<sup>1</sup>When changing oil filter you must also replace the filter cap O-ring. The oil filter drain plug O-ring must also be replaced whenever the oil filter drain plug is removed. Reuse of the O-rings may cause engine oil leakage and may result in severe engine damage. The customer warranty may be void for any damage to the engine if the O-rings are not replaced.

<sup>2</sup>The PCV valve is a critical emission component. It is one of the items listed in *scheduled maintenance information* chapter and is essential to the life and performance of your vehicle and to its emissions system.

For PCV valve replacement, see your authorized dealer. Refer to *scheduled maintenance information* chapter for the appropriate intervals for changing the PCV valve.

**Replace the PCV valve with one that meets Ford material and design specifications for your vehicle, such as a Motorcraft or equivalent replacement part. The customer warranty may be void for any damage to the emissions system if such a PCV valve is not used.**

<sup>3</sup>For spark plug replacement, see your authorized dealer. Refer to *scheduled maintenance information* chapter for the appropriate intervals for changing the spark plugs.

**Replace the spark plugs with ones that meet Ford material and design specifications for your vehicle, such as Motorcraft or equivalent replacement parts. The customer warranty may be void for any damage to the engine if such spark plugs are not used.**

<sup>4</sup>Failure to use the correct air filter element may result in severe engine damage. The customer warranty may be void for any damage to the engine if the correct air filter element is not used.

## Maintenance and Specifications

### MAINTENANCE PRODUCT SPECIFICATIONS AND CAPACITIES

Item	Capacity	Ford Part Name or equivalent	Ford Part Number / Ford Specification
Brake fluid	Between MIN and MAX lines on reservoir	Motorcraft High Performance DOT 3 Motor Vehicle Brake Fluid	PM-1 or PM-1-C / ESA-M6C25-A or WSS-M6C62-A
Body hinges, latches, door striker plates and rollers, seat tracks, fuel filler door hinge and spring, primary and auxiliary hood latches	—	Multi-Purpose Grease	XG-4 or XL-5 / ESB-M1C93-B
Engine coolant	8.5 quarts (8.0L)	Motorcraft Premium Gold Engine Coolant (yellow-colored) <sup>1</sup>	VC-7-B / WSS-M97B51-A1
Motor/Electronics (M/E) Coolant	3.7 quarts (3.5L)	Motorcraft Cooling System Stop Leak Pellets	VC-6 / WSS-M99B37-B6
Cooling system stop leak pellets	—	Motorcraft SAE 5W-20 Premium Synthetic Blend Motor Oil (US)	XO-5W20-QSP (US) CXO-5W20-LSP12 (Canada) /
Engine oil	4.5 quarts (4.25L)	Motorcraft SAE 5W-20 Super Premium Motor Oil (Canada) <sup>2</sup>	WSS-M2C930-A with API Certification Mark
Automatic eCVT transaxle fluid	5.3 quarts (5.0L) <sup>3</sup>	Motorcraft MERCON® Multi-Purpose ATF <sup>4</sup>	XT-2-QDX / MERCON

300

2007 Escape Hybrid (ehv)  
Owners Guide (post-2002-fmt)  
USA (fus)

## Maintenance and Specifications

Item	Capacity	Ford Part Name or equivalent	Ford Part Number / Ford Specification
Rear axle fluid (4WD)	2.96 pints (1.4L) <sup>5</sup>	Motorcraft SAE 80W-90 Premium Rear Axle Lubricant <sup>6</sup>	XY-80W90-QL / WSP-M2C197-A
Power Transfer Unit fluid (4WD) <sup>7</sup>	12 ounces (0.35L)	Motorcraft SAE 75W-140 Rear Axle Lubricant	XY-75W140-QL / WSL-M2C192-A
Windshield washer fluid	2.7 quarts (2.6L)	Motorcraft Premium Windshield Washer Concentrate	ZC-32-A / WSB-M8B16-A2
Fuel tank	15 gallons (56.8L)	—	—

<sup>1</sup>Add the coolant type originally equipped in your vehicle. Refer to *Adding engine coolant* in this chapter.

<sup>2</sup>Use of synthetic or synthetic blend motor oil is not mandatory. Engine oil need only meet the requirements of Ford specification WSS-M2C930-A and the API Certification mark.

<sup>3</sup>Indicates only approximate dry-fill capacity.

<sup>4</sup>Using any transmission fluid other than those that meet the recommended specification may cause internal transaxle damage. Do not use Motorcraft MERCON® CVT (blue) ATF. This vehicle uses only Motorcraft MERCON® ATF.

<sup>5</sup>Fill to 1/4 inch to 9/16 inch (6 mm to 14 mm) below bottom of fill hole.

<sup>6</sup>4WD vehicles exposed for prolonged periods to temperatures less than -40° C (-40° F) should change out the rear axle fluid to Motorcraft SAE 75W-140 Rear Axle Lubricant, Ford part number XY-75W140-QL meeting Ford specification WSL-M2C192-A.

<sup>7</sup>The Power Transfer Unit is lubricated for life with synthetic lube. Lubricant levels are not to be checked or changed unless a leak is suspected or repair required. Replace Power Transfer Unit lubricant with specified synthetic lubricant anytime the unit is submerged in water.

## Maintenance and Specifications

### ENGINE DATA

Engine	2.3L I4 engine
Cubic inches	140
Required fuel	87 octane
Firing order	1-3-4-2
Ignition system	Coil on plug
Spark plug gap	0.049–0.053 inch (1.25–1.35mm)
Compression ratio	12.3:1

### Engine drivebelt routing

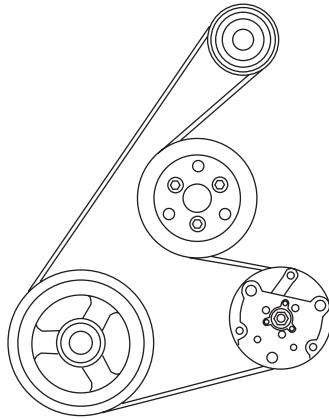

- 2.3L I4 Engine

### HIGH VOLTAGE BATTERY DATA

High Voltage Battery	
Battery chemistry	Nickel Metal Hydride
Nominal Voltage	330 Volts
Capacity	6 Amp-hours

## Maintenance and Specifications

### IDENTIFYING YOUR VEHICLE

#### Safety Compliance Certification Label

The National Highway Traffic Safety Administration Regulations require that a Safety Compliance Certification Label be affixed to a vehicle and prescribe where the Safety Compliance Certification Label may be located. The Safety Compliance Certification Label is located on the structure (B-Pillar) by the trailing edge of the driver's door or the edge of the driver's door.

MFD. BY FORD MOTOR CO.			
DATE: XX/XX	GVWR: XXXXLB/ XXXXKG		
FRONT GAWR: XXXXL	REAR GAWR: XXXXLB		
XXXXKG	WITH	XXXXKG	WITH
XXXX/XXXXXX	TIRES	XXXX/XXXXXX	TIRES
XXXX.XX	RIMS	XXXX.XX	RIMS
AT XXX kPa/XX	PSI COLD	AT XXX kPa/XX	PSI COLD
THIS VEHICLE CONFORMS TO ALL APPLICABLE FEDERAL MOTOR VEHICLE SAFETY AND THEFT PREVENTION STANDARDS IN EFFECT ON THE DATE OF MANUFACTURE SHOWN ABOVE.			
VIN: XXXXXXXXXXXXXXXXX	XXXXX XXXXX		
TYPE: XXX			
			
EXT PNT: XX	RC: XX	DSO:	
WB BRK INT TR TP/PS R AXLE TR SPR XXXX			
XXX X XX X XX X XX XXX			
XXXXXXXXXXXX XXX XXXX-XXXXXX-XX			

#### Vehicle identification number (VIN)

The vehicle identification number is attached to a metal tag and is located on the driver side instrument panel.

Please note that in the graphic, XXXX is representative of your vehicle identification number.

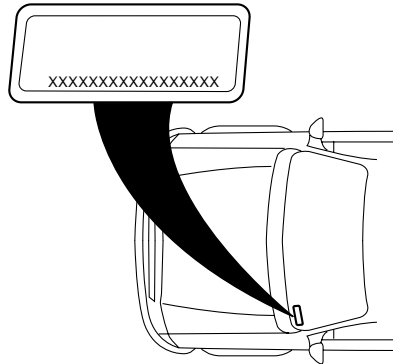

## Maintenance and Specifications

The Vehicle Identification Number (VIN) contains the following information:

1. World manufacturer identifier
2. Brake system / Gross Vehicle Weight Rating (GVWR) / Restraint System
3. Vehicle line, series, body type
4. Engine type
5. Check digit
6. Model year
7. Assembly plant
8. Production sequence number

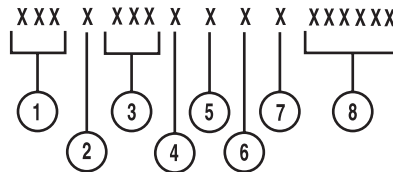

### TRANSMISSION/TRANSAXLE CODE DESIGNATIONS

You can find a transmission/transaxle code on the Safety Compliance Certification Label. The following table tells you which transmission or transaxle each code represents.

<b>MFD. BY FORD MOTOR CO.</b>	
DATE: XX/XX	GVWR: XXXXLB/ XXXXKKG
FRONT GAWR: XXXXL	REAR GAWR: XXXXLB
XXXXKKG	WITH XXXXKKG WITH
XXXX/XXXXXXXX	TIRES: XXXX/XXXXXXXX TIRES
XXXX.XX	RIMS: XXXX.XX RIMS
AT XXX kPa/XX PSI COLD	AT XXX kPa/XX PSI COLD
THIS VEHICLE CONFORMS TO ALL APPLICABLE FEDERAL MOTOR VEHICLE SAFETY AND THEFT PREVENTION STANDARDS IN EFFECT ON THE DATE OF MANUFACTURE SHOWN ABOVE.	
VIN: XXXXXXXXXXXXXXXXX	XXXXXX
TYPE: XXX	XXXXXX
XXXXXXXXXXXXXXXXXX XXX XXXX-XXXXXX-XX	
EXT PNT: XX	RC: XX
DSO: XXXX	
WB <sup>1</sup> BRK <sup>1</sup> INT TR <sup>1</sup> TP/PS <sup>1</sup> R <sup>1</sup> AXLE <sup>1</sup> TR <sup>1</sup> SPR <sup>1</sup> XXXXX	
XXX X XX X XX X XX	

Description	Code
Electronically controlled continuously variable transmission, eCVT	H



## Accessories

### GENUINE FORD ACCESSORIES FOR YOUR VEHICLE

A wide selection of Genuine Ford Accessories are available for your vehicle through your local Ford or Ford of Canada dealer. These quality accessories have been specifically engineered to fulfill your automotive needs; they are custom designed to complement the style and aerodynamic appearance of your vehicle. In addition, each accessory is made from high quality materials and meets or exceeds Ford's rigorous engineering and safety specifications. Ford Motor Company will repair or replace any properly dealer-installed Genuine Ford Accessories found to be defective in factory-supplied materials or workmanship during the warranty period, as well as any component damaged by the defective accessory. The accessories will be warranted for whichever provides you the greatest benefit:

- 12 months or 12,000 miles (20,000 km) (whichever occurs first), or
- the remainder of your new vehicle limited warranty.

This means that Genuine Ford Accessories purchased along with your new vehicle and installed by a dealer are covered for the full length of your New Vehicle's Limited Warranty — 3 years or 36,000 miles (60,000 km) (whichever occurs first). Contact your dealer for details and a copy of the warranty.

#### **Not all accessories are available for all models.**

The following is a list of several Genuine Ford Accessories. Not all accessories are available for all models. For a complete listing of the accessories that are available for your vehicle, please contact your dealer or visit our online store at: [www.fordaccessoriesstore.com](http://www.fordaccessoriesstore.com).

#### **Exterior style**

Bug shields  
Chrome exhaust tips  
Deflectors  
Running boards  
Splash guards  
Step Bars  
Wheels

#### **Interior style**

Consoles  
Floor mats

## Accessories

### Lifestyle

Ash cup / smoker's package

Cross bars

TripTunes<sup>™</sup>

### Peace of mind

Mobile-ease<sup>™</sup> hands-free communication system

Remote start

Vehicle security systems

Wheel locks

For maximum vehicle performance, keep the following information in mind when adding accessories or equipment to your vehicle:

- When adding accessories, equipment, passengers and luggage to your vehicle, do not exceed the total weight capacity of the vehicle or of the front or rear axle (GVWR or GAWR as indicated on the Safety Compliance Certification label). Consult your authorized dealer for specific weight information.
- The Federal Communications Commission (FCC) and Canadian Radio Telecommunications Commission (CRTC) regulate the use of mobile communications systems — such as two-way radios, telephones and theft alarms - that are equipped with radio transmitters. Any such equipment installed in your vehicle should comply with FCC or CRTC regulations and should be installed only by a qualified service technician.
- Mobile communications systems may harm the operation of your vehicle, particularly if they are not properly designed for automotive use.
- To avoid interference with other vehicle functions, such as anti-lock braking systems, amateur radio users who install radios and antennas onto their vehicle should not locate the Amateur Radio Antennas in the area of the driver's side hood.
- Electrical or electronic accessories or components that are added to the vehicle by the authorized dealer or the owner may adversely affect battery performance and durability.

## Scheduled Maintenance Guide

### GENERAL MAINTENANCE INFORMATION

#### Why maintain your vehicle?

This guide describes the scheduled maintenance required for your vehicle. Carefully following this schedule helps protect against major repair expenses resulting from neglect or inadequate maintenance and may also help to increase the value of your vehicle when you sell or trade it.

It is your responsibility to see that all scheduled maintenance is performed and that the materials used meet Ford engineering specifications. Failure to perform scheduled maintenance specific in this guide will invalidate warranty coverage on parts affected by the lack of maintenance. Be sure receipts for completed maintenance are kept with the vehicle and confirmation of the work performed is always recorded in this guide.

Your Ford or Lincoln Mercury dealer, or Ford or Lincoln Mercury Quality Care Center has factory trained technicians who can perform the required maintenance using genuine Ford parts. They are committed to meeting your service needs and to assuring your continuing satisfaction.

#### Protecting your investment

Maintenance is an investment that will pay dividends in the form of improved reliability, durability and resale value. To ensure the proper performance of your vehicle and its emission control systems, it is imperative that scheduled maintenance be completed at the designated intervals.

Your vehicle is very sophisticated and built with multiple complex performance systems. Every manufacturer develops these systems using different specifications and performance features. That's why it's important to rely upon your Ford or Lincoln Mercury dealership to properly diagnose and repair your vehicle.

Ford Motor Company has recommended maintenance intervals for various parts and component systems based upon engineering testing. Ford Motor Company relies upon this testing to determine the most appropriate mileage for replacement of oils and fluids to protect your vehicle at the lowest overall cost to you and recommends against maintenance schedules that deviate from the scheduled maintenance information.

Ford strongly recommends the use of genuine Ford replacement parts. Parts other than Ford, Motorcraft or Ford authorized remanufactured

## Scheduled Maintenance Guide

parts that are used for maintenance replacement or for the service of components affecting emission control must be equivalent to genuine Ford Motor Company parts in performance and durability. It is the owner's responsibility to determine the equivalency of such parts. Please consult your *Warranty Guide* for complete warranty information.

Non-Ford approved chemicals or additives are not required for factory recommended maintenance. In fact, Ford Motor Company recommends against the use of such additive products unless specifically recommended by Ford for a particular application.

### ***Oil, fluids and flushing***

In many cases, fluid discoloration is a normal operating characteristic of the chemical compound and may not necessarily demonstrate that a fluid needs to be changed. Oils and fluids identified in this guide should be changed at the specified interval or in conjunction with a repair. Flushing is a viable way to change fluid for many vehicle sub-systems during scheduled maintenance and should only be done using the same fluid required to finish the maintenance procedure, or a Ford approved flushing chemical.

### ***Engine Emissions label***

Emissions information appears on the Engine Emissions label on the underside of the hood. This decal identifies engine displacement and provides certain engine specifications.

Any modification of the emissions control system could create liability under federal law (U.S.) if made prior to sale and registration, under the laws of some states if made thereafter. Further, federal law prohibits vehicle manufacturers, dealers and other persons engaged in the business of repairing, servicing, selling, leasing or trading motor vehicles as well as fleet operations from knowingly removing or rendering an emissions control system inoperative after sale and delivery to an ultimate purchaser. In Canada, modifications of the emissions control system could create liability under applicable federal or provincial laws.

### **Genuine Ford Parts and Service**

When planning your maintenance services, consider your Ford and Lincoln Mercury dealership for all your vehicle's needs.

### **Get the most from your service and maintenance visits**

There are a lot of reasons why your Ford and Lincoln Mercury dealership is a great way to help keep your vehicle running great.

308

*2007 Escape Hybrid (ehv)*  
*Owners Guide (post-2002-fmt)*  
*USA (fus)*

## Scheduled Maintenance Guide

### **Convenience**

To make your service visit even more convenient, in many cases, you'll find extended evening hours and Saturday hours. How's that for quality service?

### **Factory-trained Technicians**

Ford and Lincoln Mercury service technicians participate in extensive factory-sponsored training to help them become the experts on the operation of your vehicle. Many participate in Ford-sponsored training to become certified. Ask your dealer about the training and certification their technicians have received.

### **Factory Authorized Systems Checks**

In the event that your vehicle experiences a component related concern, please contact your Ford or Lincoln Mercury dealership. The Ford Motor Company Trained Technicians who work at Ford or Lincoln Mercury dealerships are specifically trained to understand your vehicle.

A proper repair begins with a thorough system check. A Factory Authorized Systems Check can ONLY be found at a Ford or Lincoln Mercury dealership. In some circumstances, the technician may need to request your authorization to perform additional operations to determine the final diagnosis. The technician's goal is to ensure that your vehicle is fixed right the first time, at the best value to you.

The following list represents several of the Factory Authorized Systems Checks available at a participating Ford or Lincoln Mercury dealers:

- Air Conditioning
- Check Engine Light
- All Wheel Drive and 4 X 4
- Automatic Transmission
- Engine Cooling and Cabin Heating
- Steering and Suspension
- Charge/Start/Battery
- Wheel Alignment
- Anti-Lock Brake System

### **Genuine Ford and Motorcraft Replacement Parts**

Ford and Lincoln Mercury dealerships stock Ford and Motorcraft branded replacement parts. These parts meet or exceed Ford Motor

## Scheduled Maintenance Guide

Company's specifications, and we stand behind them. Maintenance parts installed at your Ford or Lincoln Mercury dealership carry a nationwide, 12 months, 12,000 mile parts and labor limited warranty. Your dealer can give you details.

### **Value Shopping for Your Vehicle's Maintenance Needs**

Your dealership recognizes the competitive landscape of maintenance and light repair automotive services. With factory-trained technicians, and one-stop service from routine maintenance like oil changes and tire rotations to repairs like brake service, check out the value your Ford and Lincoln Mercury dealers can offer.

### **WHICH MAINTENANCE SCHEDULE SHOULD YOU FOLLOW?**

#### **Owner Checks and Services**

#### **Refer to Mileage Intervals for Additional Checks and Services**

Certain basic maintenance checks and inspections should be performed by the owner or a service technician at the intervals indicated. Service information and supporting specifications are provided in this *Owner's Guide*.

Any adverse condition should be brought to the attention of your dealer or qualified service technician as soon as possible for the proper service advice. The owner maintenance service checks are generally not covered by warranties so you may be charged for labor, parts or lubricants used.

#### **Maximum Oil Change Interval**

- 12 months, 10,000 miles (16,000 km) or 200 hours of engine operation.

#### **Motorcraft Premium Gold Engine Coolant change interval**

- 6 years or 100,000 miles (160,000 km) - change Motorcraft Premium Gold Engine Coolant (whichever comes first)
- After initial change - change Motorcraft Premium Gold Engine Coolant every 3 years or 50,000 miles (80,000 km).

#### **Check every month**

- Check function of all interior and exterior lights
- Check tires for wear and correct air pressure, including spare tire
- Check windshield washer fluid level
- Check engine oil level

## Scheduled Maintenance Guide

### Check every six months

- Check lap/shoulder belts and seat latches for wear and function
- Check that externally mounted spare tire is properly stowed (tight)
- Check parking brake for proper operation
- Check safety warning lamps (brake, ABS, air bag, safety belt) for operation
- Check cooling system fluid level and coolant strength
- Check low voltage (underhood) battery connections and clean if necessary
- Check washer spray, wiper operation and clean all wiper blades (replace as necessary)
- Check and lubricate all hinges, latches and outside locks. Inspect for correct operation
- Check and lubricate door rubber weatherstrips. Inspect for excessive wear
- Check and clean body and door drain holes. Inspect for clogs and obstructions

### Multi-point Inspection

In order to keep your vehicle running right, it is important that you have the systems on your vehicle checked regularly. This can help identify any potential issue before there are any problems. Ford Motor Company suggests the following multi-point inspection to be performed at every scheduled maintenance as the way to ensure your vehicle keeps running right.

### Multi-point inspection - Recommended at every visit

- Check and top up fluid levels: brake, engine coolant recovery reservoir, motor/electronics reservoir and window washer.
- Inspect tires for wear and correct air pressure.
- Check exhaust system for leaks, damage, loose parts and foreign materials.
- Check low voltage (underhood) battery performance.
- Check operation of horn, exterior lamps, turn signals and hazard warning lights.
- Check radiator, coolers and heater and air conditioning hoses.
- Inspect windshield washer spray and wiper operation.
- Check windshield for cracks, chips and pitting.
- Inspect for oil and fluid leaks.
- Inspect engine air cleaner filter and elements.
- Inspect half-shaft dust boots.
- Check shocks, struts and other suspension components for leaks and damage.

### NORMAL SCHEDULED MAINTENANCE AND LOG

The following section contains the “Normal Schedule”. This schedule is presented at specific mileage (kilometer) intervals with exceptions noted.

### ADDITIONAL INFORMATION AVAILABLE ON THE WEB

To learn more about the importance of routine and dealer-performed maintenance on your vehicle, please visit the Ford Customer Service Web

## Scheduled Maintenance Guide

site. You'll also find important warranty information, customer assistance, technical expertise, frequently asked questions and much more. The Web site location is: [www.ford.com](http://www.ford.com).

Then go to the vehicles and services pick at the Web site.

### U.S. SCHEDULE

5,000 miles (8,000 km)	
<input type="checkbox"/> Inspect tires for wear and measure tread depth <input type="checkbox"/> Rotate tires	<div style="border: 1px solid black; padding: 5px;"> <p style="text-align: center;">DEALER VALIDATION:</p>    <p>RO#:                      P&amp;A CODE:            DATE:                    MILEAGE:</p> </div>
10,000 miles (16,000 km)	
<input type="checkbox"/> Change engine oil and replace oil filter <input type="checkbox"/> Inspect tires for wear and measure tread depth <input type="checkbox"/> Rotate tires <input type="checkbox"/> Inspect high voltage battery A/C filter, replace if necessary	<div style="border: 1px solid black; padding: 5px;"> <p style="text-align: center;">DEALER VALIDATION:</p>    <p>RO#:                      P&amp;A CODE:            DATE:                    MILEAGE:</p> </div>
20,000 miles (32,000 km)	
<input type="checkbox"/> Change engine oil and replace oil filter <input type="checkbox"/> Inspect tires for wear and measure tread depth <input type="checkbox"/> Rotate tires <input type="checkbox"/> Inspect brake pads, shoes, rotors, drums, brake lines and hoses and parking brake <input type="checkbox"/> Inspect engine and motor/electrical cooling system and hoses <input type="checkbox"/> Inspect steering linkage, suspension and, if equipped, half-shafts, driveshaft and ball joints <input type="checkbox"/> Inspect exhaust system and heat shields <input type="checkbox"/> Replace high voltage battery A/C filter	<div style="border: 1px solid black; padding: 5px;"> <p style="text-align: center;">DEALER VALIDATION:</p>    <p>RO#:                      P&amp;A CODE:            DATE:                    MILEAGE:</p> </div>



## Scheduled Maintenance Guide

### 30,000 miles (48,000 km)

- Change engine oil and replace oil filter
- Inspect tires for wear and measure tread depth
- Rotate tires
- Inspect high voltage battery A/C filter, replace if necessary
- Replace engine air filter

DEALER VALIDATION:

RO#:

P&A CODE:

DATE:

MILEAGE:

### 40,000 miles (64,000 km)

- Change engine oil and replace oil filter
- Inspect tires for wear and measure tread depth
- Rotate tires
- Inspect brake pads, shoes, rotors, drums, brake lines and hoses and parking brake
- Inspect engine and motor/electrical cooling system and hoses
- Inspect steering linkage, suspension and, if equipped, half-shafts, driveshaft and ball joints
- Inspect exhaust system and heat shields
- Replace high voltage battery A/C filter

DEALER VALIDATION:

RO#:

P&A CODE:

DATE:

MILEAGE:

### 50,000 miles (80,000 km)

- Change engine oil and replace oil filter
- Inspect tires for wear and measure tread depth
- Rotate tires
- Inspect high voltage battery A/C filter, replace if necessary

DEALER VALIDATION:

RO#:

P&A CODE:

DATE:

MILEAGE:

## Scheduled Maintenance Guide

### 60,000 miles (96,000 km)

- Change engine oil and replace oil filter
- Inspect tires for wear and measure tread depth
- Rotate tires
- Inspect brake pads, shoes, rotors, drums, brake lines and hoses and parking brake
- Inspect engine and motor/electrical cooling system and hoses
- Inspect steering linkage, suspension and, if equipped, half-shafts, driveshaft and ball joints
- Inspect exhaust system and heat shields
- Replace high voltage battery A/C filter
- Replace engine air filter

DEALER VALIDATION:

RO#: P&A CODE:  
DATE: MILEAGE:

### 70,000 miles (112,000 km)

- Change engine oil and replace oil filter
- Inspect tires for wear and measure tread depth
- Rotate tires
- Inspect high voltage battery A/C filter, replace if necessary

DEALER VALIDATION:

RO#: P&A CODE:  
DATE: MILEAGE:

### 80,000 miles (128,000 km)

- Change engine oil and replace oil filter
- Inspect tires for wear and measure tread depth
- Rotate tires
- Inspect brake pads, shoes, rotors, drums, brake lines and hoses and parking brake
- Inspect engine and motor/electrical cooling system and hoses
- Inspect steering linkage, suspension and, if equipped, half-shafts, driveshaft and ball joints
- Inspect exhaust system and heat shields
- Replace high voltage battery A/C filter

DEALER VALIDATION:

RO#: P&A CODE:  
DATE: MILEAGE:

## Scheduled Maintenance Guide

### 90,000 miles (144,000 km)

- Change engine oil and replace oil filter
- Inspect tires for wear and measure tread depth
- Rotate tires
- Inspect high voltage battery A/C filter, replace if necessary
- Replace engine air filter

DEALER VALIDATION:

RO#:                      P&A CODE:  
DATE:                     MILEAGE:

### 100,000 miles (160,000 km)

- Change engine oil and replace oil filter
- Inspect tires for wear and measure tread depth
- Rotate tires
- Inspect brake pads, shoes, rotors, drums, brake lines and hoses and parking brake
- Inspect engine and motor/electrical cooling system and hoses
- Inspect steering linkage, suspension and, if equipped, half-shafts, driveshaft and ball joints
- Inspect exhaust system and heat shields
- Replace high voltage battery A/C filter
- Replace fuel filter
- Replace engine coolant and motor/electrical coolant (see Motorcraft Premium Gold Coolant Change Record)
- Inspect accessory drive belt
- Replace spark plugs

DEALER VALIDATION:

RO#:                      P&A CODE:  
DATE:                     MILEAGE:

### 110,000 miles (176,000 km)

- Change engine oil and replace oil filter
- Inspect tires for wear and measure tread depth
- Rotate tires
- Inspect high voltage battery A/C filter, replace if necessary

DEALER VALIDATION:

RO#:                      P&A CODE:  
DATE:                     MILEAGE:

## Scheduled Maintenance Guide

### 120,000 miles (192,000 km)

- Change engine oil and replace oil filter
- Inspect tires for wear and measure tread depth
- Rotate tires
- Inspect brake pads, shoes, rotors, drums, brake lines and hoses and parking brake
- Inspect engine and motor/electrical cooling system and hoses
- Inspect steering linkage, suspension and, if equipped, half-shafts, driveshaft and ball joints
- Inspect exhaust system and heat shields
- Replace high voltage battery A/C filter
- Replace engine air filter

DEALER VALIDATION:

RO#: P&A CODE:  
DATE: MILEAGE:

### 130,000 miles (208,000 km)

- Change engine oil and replace oil filter
- Inspect tires for wear and measure tread depth
- Rotate tires
- Inspect high voltage battery A/C filter, replace if necessary

DEALER VALIDATION:

RO#: P&A CODE:  
DATE: MILEAGE:

### 140,000 miles (224,000 km)

- Change engine oil and replace oil filter
- Inspect tires for wear and measure tread depth
- Rotate tires
- Inspect brake pads, shoes, rotors, drums, brake lines and hoses and parking brake
- Inspect engine and motor/electrical cooling system and hoses
- Inspect steering linkage, suspension and, if equipped, half-shafts, driveshaft and ball joints
- Inspect exhaust system and heat shields
- Replace high voltage battery A/C filter

DEALER VALIDATION:

RO#: P&A CODE:  
DATE: MILEAGE:

## Scheduled Maintenance Guide

### 150,000 miles (240,000 km)

- Change engine oil and replace oil filter
- Inspect tires for wear and measure tread depth
- Rotate tires
- Replace high voltage battery A/C filter
- Replace engine air filter
- Replace engine coolant and motor/electrical coolant (see Motorcraft Premium Gold Coolant Change Record)
- Replace accessory drive belt (if not replaced in the last 100,000 miles)
- Inspect PCV valve for flow and replace, if required
- Replace rear axle lubricant (4WD vehicles only)

<b>DEALER VALIDATION:</b>	
<b>RO#:</b>	<b>P&amp;A CODE:</b>
<b>DATE:</b>	<b>MILEAGE:</b>

### CANADIAN SCHEDULE

For items marked with an asterisk (\*), more frequent service intervals will be required. Refer to *Special operating conditions* at the end of this section for more information.

### 3,000 miles (5,000 km)

- Change engine oil and replace oil filter\*
- Inspect tires for wear and measure tread depth
- Inspect high voltage battery A/C filter, replace if necessary\*
- Multipoint inspection\*

<b>DEALER VALIDATION:</b>	
<b>RO#:</b>	<b>P&amp;A CODE:</b>
<b>DATE:</b>	<b>MILEAGE:</b>

### 9,000 miles (15,000 km)

- Change engine oil and replace oil filter\*
- Inspect tires for wear and measure tread depth
- Inspect high voltage battery A/C filter, replace if necessary\*
- Multipoint inspection\*

<b>DEALER VALIDATION:</b>	
<b>RO#:</b>	<b>P&amp;A CODE:</b>
<b>DATE:</b>	<b>MILEAGE:</b>

## Scheduled Maintenance Guide

### 18,500 miles (30,000 km)

- Change engine oil and replace oil filter\*
- Inspect tires for wear and measure tread depth
- Inspect brake pads, shoes, rotors, drums, brake lines and hoses and parking brake
- Inspect engine and motor/electrical cooling system and hoses
- Lubricate hinges, latches and locks
- Lubricate weatherstrips
- Inspect steering linkage, suspension and, if equipped, drive-shaft and ball joints
- Replace high voltage battery A/C filter
- Inspect engine air filter\*
- Multipoint inspection\*

DEALER VALIDATION:

RO#: P&A CODE:  
DATE: MILEAGE:

### 28,000 miles (45,000 km)

- Change engine oil and replace oil filter\*
- Inspect tires for wear and measure tread depth
- Inspect high voltage battery A/C filter, replace if necessary\*
- Multipoint inspection\*

DEALER VALIDATION:

RO#: P&A CODE:  
DATE: MILEAGE:

### 37,500 miles (60,000 km)

- Change engine oil and replace oil filter\*
- Inspect tires for wear and measure tread depth
- Inspect brake pads, shoes, rotors, drums, brake lines and hoses and parking brake
- Inspect engine and motor/electrical cooling system and hoses
- Lubricate hinges, latches and locks
- Lubricate weatherstrips
- Inspect steering linkage, suspension and, if equipped, drive-shaft and ball joints
- Replace high voltage battery A/C filter
- Replace engine air filter\*
- Multipoint inspection\*

DEALER VALIDATION:

RO#: P&A CODE:  
DATE: MILEAGE:

## Scheduled Maintenance Guide

### 47,000 miles (75,000 km)

- Change engine oil and replace oil filter\*
- Inspect tires for wear and measure tread depth
- Inspect high voltage battery A/C filter, replace if necessary\*
- Multipoint inspection\*

DEALER VALIDATION:

RO#:

P&A CODE:

DATE:

MILEAGE:

### 56,000 miles (90,000 km)

- Change engine oil and replace oil filter\*
- Inspect tires for wear and measure tread depth
- Inspect brake pads, shoes, rotors, drums, brake lines and hoses and parking brake
- Inspect engine and motor/electrical cooling system and hoses
- Lubricate hinges, latches and locks
- Lubricate weatherstrips
- Inspect steering linkage, suspension and, if equipped, drive-shaft and ball joints
- Replace high voltage battery A/C filter
- Inspect engine air filter\*
- Multipoint inspection\*

DEALER VALIDATION:

RO#:

P&A CODE:

DATE:

MILEAGE:

### 65,000 miles (105,000 km)

- Change engine oil and replace oil filter\*
- Inspect tires for wear and measure tread depth
- Inspect high voltage battery A/C filter, replace if necessary\*
- Multipoint inspection\*

DEALER VALIDATION:

RO#:

P&A CODE:

DATE:

MILEAGE:

## Scheduled Maintenance Guide

### 75,000 miles (120,000 km)

- Change engine oil and replace oil filter\*
- Inspect tires for wear and measure tread depth
- Inspect brake pads, shoes, rotors, drums, brake lines and hoses and parking brake
- Inspect engine and motor/electrical cooling system and hoses
- Lubricate hinges, latches and locks
- Lubricate weatherstrips
- Inspect steering linkage, suspension and, if equipped, drive-shaft and ball joints
- Replace high voltage battery A/C filter
- Replace engine air filter\*
- Replace fuel filter\*
- Replace engine coolant and motor/electrical coolant\* (see Motorcraft Premium Gold Coolant Change Record)
- Multipoint inspection\*
- Inspect PCV valve for flow, replace if required\*

DEALER VALIDATION:

RO#: P&A CODE:  
DATE: MILEAGE:

### 84,000 miles (135,000 km)

- Change engine oil and replace oil filter\*
- Inspect tires for wear and measure tread depth
- Inspect high voltage battery A/C filter, replace if necessary\*
- Multipoint inspection\*

DEALER VALIDATION:

RO#: P&A CODE:  
DATE: MILEAGE:

### 94,000 miles (150,000 km)

- Change engine oil and replace oil filter\*
- Inspect tires for wear and measure tread depth
- Inspect brake pads, shoes, rotors, drums, brake lines and hoses and parking brake
- Inspect engine and motor/electrical cooling system and hoses
- Lubricate hinges, latches and locks
- Lubricate weatherstrips
- Inspect steering linkage, suspension and, if equipped, drive-shaft and ball joints
- Replace high voltage battery A/C filter
- Inspect engine air filter\*
- Multipoint inspection\*
- Replace spark plugs\*

DEALER VALIDATION:

RO#: P&A CODE:  
DATE: MILEAGE:



## Scheduled Maintenance Guide

### 103,000 miles (165,000 km)

- Change engine oil and replace oil filter\*
- Inspect tires for wear and measure tread depth
- Inspect high voltage battery A/C filter, replace if necessary\*
- Multipoint inspection\*

DEALER VALIDATION:

RO#:                      P&A CODE:  
DATE:                     MILEAGE:

### 112,000 miles (180,000 km)

- Change engine oil and replace oil filter\*
- Inspect tires for wear and measure tread depth
- Inspect brake pads, shoes, rotors, drums, brake lines and hoses and parking brake
- Inspect engine and motor/electrical cooling system and hoses
- Lubricate hinges, latches and locks
- Lubricate weatherstrips
- Inspect steering linkage, suspension and, if equipped, drive-shaft and ball joints
- Replace high voltage battery A/C filter
- Replace engine air filter\*
- Replace engine coolant and motor/electrical coolant\* (see Motorcraft Premium Gold Coolant Change Record)
- Multipoint inspection\*

DEALER VALIDATION:

RO#:                      P&A CODE:  
DATE:                     MILEAGE:

### 120,000 miles (195,000 km)

- Change engine oil and replace oil filter\*
- Inspect tires for wear and measure tread depth
- Inspect high voltage battery A/C filter, replace if necessary\*
- Multipoint inspection\*

DEALER VALIDATION:

RO#:                      P&A CODE:  
DATE:                     MILEAGE:

## Scheduled Maintenance Guide

### 130,000 miles (210,000 km)

- Change engine oil and replace oil filter\*
- Inspect tires for wear and measure tread depth
- Inspect brake pads, shoes, rotors, drums, brake lines and hoses and parking brake
- Inspect engine and motor/electrical cooling system and hoses
- Lubricate hinges, latches and locks
- Lubricate weatherstrips
- Inspect steering linkage, suspension and, if equipped, drive-shaft and ball joints
- Replace high voltage battery A/C filter
- Inspect engine air filter\*
- Multipoint inspection\*

DEALER VALIDATION:

RO#: P&A CODE:  
DATE: MILEAGE:

### 140,000 miles (225,000 km)

- Change engine oil and replace oil filter\*
- Inspect tires for wear and measure tread depth
- Inspect high voltage battery A/C filter, replace if necessary\*
- Multipoint inspection\*

DEALER VALIDATION:

RO#: P&A CODE:  
DATE: MILEAGE:

### 150,000 miles (240,000 km)

- Change engine oil and replace oil filter\*
- Inspect tires for wear and measure tread depth
- Inspect brake pads, shoes, rotors, drums, brake lines and hoses and parking brake
- Inspect engine and motor/electrical cooling system and hoses
- Lubricate hinges, latches and locks
- Lubricate weatherstrips
- Inspect steering linkage, suspension and, if equipped, drive-shaft and ball joints
- Replace high voltage battery A/C filter
- Replace engine air filter\*
- Replace fuel filter\*
- Replace engine coolant and motor/electrical coolant\* (see Motorcraft Premium Gold Coolant Change Record)
- Multipoint inspection\*
- Replace accessory drive belt
- Replace PCV valve
- Replace rear axle lubricant (4WD vehicles only)

DEALER VALIDATION:

RO#: P&A CODE:  
DATE: MILEAGE:

## Scheduled Maintenance Guide

### 159,000 miles (255,000 km)

- Change engine oil and replace oil filter\*
- Inspect tires for wear and measure tread depth
- Inspect high voltage battery A/C filter, replace if necessary\*
- Multipoint inspection\*

DEALER VALIDATION:

RO#: P&A CODE:  
DATE: MILEAGE:

### 168,000 miles (270,000 km)

- Change engine oil and replace oil filter\*
- Inspect tires for wear and measure tread depth
- Inspect brake pads, shoes, rotors, drums, brake lines and hoses and parking brake
- Inspect engine and motor/electrical cooling system and hoses
- Lubricate hinges, latches and locks
- Lubricate weatherstrips
- Inspect steering linkage, suspension and, if equipped, drive-shaft and ball joints
- Replace high voltage battery A/C filter
- Inspect engine air filter\*
- Multipoint inspection\*

DEALER VALIDATION:

RO#: P&A CODE:  
DATE: MILEAGE:

### 177,000 miles (285,000 km)

- Change engine oil and replace oil filter\*
- Inspect tires for wear and measure tread depth
- Inspect high voltage battery A/C filter, replace if necessary\*
- Multipoint inspection\*

DEALER VALIDATION:

RO#: P&A CODE:  
DATE: MILEAGE:

## Scheduled Maintenance Guide

### 188,000 miles (300,000 km)

- Change engine oil and replace oil filter\*
- Inspect tires for wear and measure tread depth
- Inspect brake pads, shoes, rotors, drums, brake lines and hoses and parking brake
- Inspect engine and motor/electrical cooling system and hoses
- Lubricate hinges, latches and locks
- Lubricate weatherstrips
- Inspect steering linkage, suspension and, if equipped, drive-shaft and ball joints
- Replace high voltage battery A/C filter
- Replace engine air filter\*
- Replace engine coolant and motor/electrical coolant\* (see Motorcraft Premium Gold Coolant Change Record)
- Multipoint inspection\*
- Replace spark plugs\*

#### DEALER VALIDATION:

RO#: P&A CODE:  
DATE: MILEAGE:

### Special operating conditions

If your vehicle is operated in any of the following manners, you will need to perform some maintenance operations more frequently:

- Towing a trailer or using a camper or car-top carrier
- Extensive idling and/or low-speed driving for long distances as in heavy commercial use such as delivery, taxi, patrol or livery
- Operating in dusty conditions such as unpaved or dusty roads
- Off-road operation

If any of the above conditions apply to your vehicle operation, you will need to perform the following maintenance operations in addition to the operations listed in the maintenance schedule:

**Every 8,000 km** Change engine oil and replace oil filter  
Rotate tires  
Inspect high voltage battery A/C filter  
Inspect engine air filter  
Perform multipoint inspection

**Every 60,000 km** Replace fuel filter

**Every 120,000 km** Replace spark plugs

## Scheduled Maintenance Guide

### SPECIAL OPERATING CONDITIONS

#### Towing a trailer or using a camper or car-top carrier

**Every 5,000 miles, 12 months or 200 hours of engine operation (whichever comes first)** Change engine oil and replace filter  
**Every 5,000 miles** Rotate tires

#### Extensive Idling and/or Low Speed Driving for Long Distances as in Heavy Commercial Use Such as Delivery, Taxi, Patrol Vehicle or Livery. Severe Duty Schedule is for Extensive Maximum A/C or Heater Operation with engine on in the above listed usage.

**Every 5,000 miles, 12 months or 200 hours of engine operation (whichever comes first)** Change engine oil and replace filter  
**Every 5,000 miles** Rotate tires  
**Every 60,000 miles** Replace spark plugs  
**As required** Replace cabin air filter, if equipped

#### Operating in dusty conditions such as unpaved or dusty roads

**Every 5,000 miles, 12 months or 200 hours of engine operation (whichever comes first)** Change engine oil and replace filter  
**As required** Rotate tires  
Replace cabin air filter, if equipped  
Replace engine air filter  
Replace high voltage battery A/C air filter

#### Off-road operation

**Every 5,000 miles, 12 months or 200 hours of engine operation (whichever comes first)** Change engine oil and replace filter  
**As required** Rotate tires  
Replace cabin air filter, if equipped  
Replace engine air filter  
Replace high voltage battery A/C filter

## Scheduled Maintenance Guide

### Special Operating Conditions Log

DEALER VALIDATION:	DEALER VALIDATION:
RO#: P&A CODE: DATE: MILEAGE:	RO#: P&A CODE: DATE: MILEAGE:
DEALER VALIDATION:	DEALER VALIDATION:
RO#: P&A CODE: DATE: MILEAGE:	RO#: P&A CODE: DATE: MILEAGE:
DEALER VALIDATION:	DEALER VALIDATION:
RO#: P&A CODE: DATE: MILEAGE:	RO#: P&A CODE: DATE: MILEAGE:
DEALER VALIDATION:	DEALER VALIDATION:
RO#: P&A CODE: DATE: MILEAGE:	RO#: P&A CODE: DATE: MILEAGE:
DEALER VALIDATION:	DEALER VALIDATION:
RO#: P&A CODE: DATE: MILEAGE:	RO#: P&A CODE: DATE: MILEAGE:

## Scheduled Maintenance Guide

### Special Operating Conditions Log

<p style="text-align: center;">DEALER VALIDATION:</p>  <p>RO#:            P&amp;A CODE: DATE:           MILEAGE:</p>	<p style="text-align: center;">DEALER VALIDATION:</p>  <p>RO#:            P&amp;A CODE: DATE:           MILEAGE:</p>
<p style="text-align: center;">DEALER VALIDATION:</p>  <p>RO#:            P&amp;A CODE: DATE:           MILEAGE:</p>	<p style="text-align: center;">DEALER VALIDATION:</p>  <p>RO#:            P&amp;A CODE: DATE:           MILEAGE:</p>
<p style="text-align: center;">DEALER VALIDATION:</p>  <p>RO#:            P&amp;A CODE: DATE:           MILEAGE:</p>	<p style="text-align: center;">DEALER VALIDATION:</p>  <p>RO#:            P&amp;A CODE: DATE:           MILEAGE:</p>
<p style="text-align: center;">DEALER VALIDATION:</p>  <p>RO#:            P&amp;A CODE: DATE:           MILEAGE:</p>	<p style="text-align: center;">DEALER VALIDATION:</p>  <p>RO#:            P&amp;A CODE: DATE:           MILEAGE:</p>
<p style="text-align: center;">DEALER VALIDATION:</p>  <p>RO#:            P&amp;A CODE: DATE:           MILEAGE:</p>	<p style="text-align: center;">DEALER VALIDATION:</p>  <p>RO#:            P&amp;A CODE: DATE:           MILEAGE:</p>





## Scheduled Maintenance Guide

Current mileage goes here => Add 50,000 miles to the current miles                    + 50,000 Next change due at this mileage => <b>Or</b> Today's date goes here => Add 3 years                    + 00 / 00 / 03 Date of next change => <b>whichever comes first</b>	<b>Dealer Stamp</b>           <b>P &amp; A CODE</b> <b>R.O.#</b>
--	--

<b>Motorcraft Premium Engine Gold Coolant - Canada</b>	
<input type="checkbox"/> 6 years or 75,000 miles (120,000 km) (whichever comes first) - change Motorcraft Premium Engine Coolant and motor/electrical coolant. <input type="checkbox"/> After initial change - change Motorcraft Premium Engine Coolant every 3 years or 40,000 miles (60,000 km)	

Current odometer reading goes here => Add 60,000 km to the current odometer reading                    + 60,000 <b>OR</b> Today's date goes here => Add 3 years                    + 00 / 00 / 03 Date of next change => <b>Whichever comes first</b>	<b>Dealer Stamp</b>           <b>P &amp; A CODE</b> <b>R.O.#</b>
---	--

Current odometer reading goes here => Add 60,000 km to the current odometer reading                    + 60,000 <b>OR</b> Today's date goes here => Add 3 years                    + 00 / 00 / 03 Date of next change => <b>Whichever comes first</b>	<b>Dealer Stamp</b>           <b>P &amp; A CODE</b> <b>R.O.#</b>
---	--

## Scheduled Maintenance Guide

<p>Current odometer reading goes here =&gt;          Add 60,000 km to the current odometer reading + 60,000</p> <p><b>OR</b></p> <p>Today's date goes here =&gt;          Add 3 years + 00 / 00 / 03</p> <p>Date of next change =&gt;  <b>Whichever comes first</b></p>	<p><b>Dealer Stamp</b></p>    <p><b>P &amp; A CODE</b>  <b>R.O.#</b></p>
---	--

<p>Current odometer reading goes here =&gt;          Add 60,000 km to the current odometer reading + 60,000</p> <p><b>OR</b></p> <p>Today's date goes here =&gt;          Add 3 years + 00 / 00 / 03</p> <p>Date of next change =&gt;  <b>Whichever comes first</b></p>	<p><b>Dealer Stamp</b></p>    <p><b>P &amp; A CODE</b>  <b>R.O.#</b></p>
---	--

## Index

### A

Accessory delay .....91  
Air cleaner filter .....297–299  
Airbag supplemental restraint system .....143, 152, 155  
    and child safety seats .....145  
    description .....143, 152, 155  
    disposal .....158  
    driver airbag .....145, 153, 156  
    indicator light .....151, 154, 157  
    operation .....145, 153, 156  
    passenger airbag .....145, 153, 156  
    side airbag .....152  
All Wheel Drive (AWD),  
driving off road .....215  
Ambulance packages .....10  
Anti-lock brake system  
(see Brakes) .....206–207  
Anti-theft system .....117, 119  
    arming the system .....119  
    disarming a triggered  
    system .....120  
    triggering .....120  
Audio system (see Radio) ...20, 25  
Automatic transaxle  
    fluid, adding .....294  
    fluid, checking .....294  
Automatic transmission  
    driving an automatic  
    overdrive .....211  
    fluid, refill capacities .....300  
    fluid, specification .....300  
Auxiliary power point .....88  
Axle  
    lubricant specifications .....300  
    refill capacities .....300

### B

Battery .....275

acid, treating emergencies .....275  
    jumping a disabled  
    battery .....244, 248  
    maintenance-free .....275  
    replacement, specifications ...299  
    servicing .....275  
BeltMinder .....139  
Brakes .....206  
    anti-lock .....206–207  
    anti-lock brake system (ABS)  
    warning light .....207  
    fluid, checking and adding ...293  
    fluid, refill capacities .....300  
    fluid, specifications .....300  
    lubricant specifications .....300  
    parking .....208  
    shift interlock .....210  
Bulbs .....82

### C

Capacities for refilling fluids ....300  
Cargo area shade .....106  
Cell phone use .....11  
Child safety restraints .....159  
    child safety belts .....159  
Child safety seats .....162  
    attaching with tether straps ..166  
    in front seat .....163  
    in rear seat .....163  
Cleaning your vehicle  
    engine compartment .....261  
    instrument panel .....263  
    interior .....264  
    interior trim .....264  
    plastic parts .....262  
    washing .....260  
    waxing .....260  
    wheels .....261  
    wiper blades .....263

## Index

- Climate control (see Air conditioning or Heating) .....74
- Clock .....21
- Clock adjust  
6-CD in dash .....28, 32  
AM/FM/Tape/CD .....21
- Console .....88
- Controls  
power seat .....122
- Coolant  
checking and adding .....277–279  
refill capacities .....282, 300  
specifications .....300
- Cruise control  
(see Speed control) .....92
- Customer Assistance .....222  
Ford Extended Service  
Plan .....257  
Getting assistance outside the  
U.S. and Canada .....257  
Getting roadside assistance ...222  
Getting the service you  
need .....253  
Ordering additional owner's  
literature .....258  
Utilizing the  
Mediation/Arbitration  
Program .....256
- D**
- Daytime running lamps  
(see Lamps) .....78
- Defrost  
rear window .....75
- Dipstick  
automatic transmission  
fluid .....294  
engine oil .....272
- Driving under special  
conditions .....212, 217, 219  
sand .....218  
snow and ice .....220  
through water .....218, 221
- E**
- Electronic message center .....96
- Emergencies, roadside  
jump-starting .....244, 248
- Emission control system .....291
- Engine .....302  
cleaning .....261  
idle speed control .....275  
lubrication specifications .....300  
refill capacities .....300  
service points .....270
- Engine block heater .....206
- Engine oil .....272  
checking and adding .....272  
dipstick .....272  
filter, specifications .....274, 299  
recommendations .....274  
refill capacities .....300  
specifications .....300
- Exhaust fumes .....205
- F**
- Fluid capacities .....300
- Foglamps .....78
- Four-Wheel Drive vehicles  
driving off road .....215  
preparing to drive your  
vehicle .....209
- Fuel .....283  
calculating fuel  
economy .....97, 288

332

**2007 Escape Hybrid (ehv)  
Owners Guide (post-2002-fmt)  
USA (fus)**

## Index

- cap .....285
- capacity .....300
- choosing the right fuel .....286
- comparisons with EPA fuel
- economy estimates .....290
- detergent in fuel .....288
- filling your vehicle
- with fuel .....283, 285, 288
- filter, specifications .....283, 299
- fuel pump/high voltage
- shut-off switches .....224
- improving fuel economy .....288
- octane rating .....287, 302
- quality .....287
- running out of fuel .....288
- safety information relating to
- automotive fuels .....283
- Fuses .....225, 227
- G**
- Gas cap (see Fuel cap) .....285
- Gas mileage
- (see Fuel economy) .....288
- Gauges .....18
- H**
- Hazard flashers .....223
- Head restraints .....121, 124
- Headlamps .....76
- aiming .....79
- autolamp system .....76
- bulb specifications .....82
- daytime running lights .....78
- flash to pass .....77
- high beam .....77
- replacing bulbs .....82
- turning on and off .....76
- Hood .....269
- I**
- Ignition .....203, 302
- Illuminated visor mirror .....88
- Infant seats
- (see Safety seats) .....162
- Inspection/maintenance (I/M)
- testing .....292
- Instrument panel
- cleaning .....263
- cluster .....14
- lighting up panel and
- interior .....79
- J**
- Jump-starting your
- vehicle .....244, 248
- K**
- Keyless entry system
- autolock .....110
- Keys .....118
- positions of the ignition .....203
- L**
- Lamps
- autolamp system .....76
- bulb replacement
- specifications chart .....82
- daytime running light .....78
- fog lamps .....78
- headlamps .....76
- headlamps, flash to pass .....77
- instrument panel, dimming .....79
- interior lamps .....80–82
- replacing bulbs .....82

## Index

- Lane change indicator  
(see Turn signal) .....80
- Liftgate .....105
- Lights, warning and indicator ....14  
anti-lock brakes (ABS) .....207
- Load limits .....191
- Loading instructions .....197
- Locks  
autolock .....110  
childproof .....112
- Lubricant specifications .....300
- Lug nuts .....243
- Luggage rack .....107
- M**
- Manual transmission  
fluid capacities .....300  
lubricant specifications .....300
- Message center .....96  
english/metric button .....99  
system check button .....98  
warning messages .....100
- Mirrors .....92  
fold away .....92  
heated .....92  
side view mirrors (power) .....92
- Moon roof .....95
- Motorcraft parts .....265, 283, 299
- N**
- Navigation system .....36  
quick start .....41  
radio functions .....46  
setting the clock .....71
- O**
- Octane rating .....287
- Oil (see Engine oil) .....272
- P**
- Parking brake .....208
- Parts (see Motorcraft parts) ....299
- Passenger Occupant  
Classification Sensor .....131
- Power distribution box  
(see Fuses) .....229
- Power door locks .....109
- Power mirrors .....92
- Power point .....88
- Power steering .....208
- Power Windows .....90
- Preparing to drive your  
vehicle .....209
- R**
- Radio .....20, 25
- Rear window defroster .....75
- Relays .....225
- Remote entry system .....112  
illuminated entry .....116–117  
locking/unlocking  
doors .....109, 113  
panic alarm .....114  
replacement/additional  
transmitters .....115  
replacing the batteries .....114
- Reverse sensing system .....212
- Roadside assistance .....222
- Roof rack .....107
- S**
- Safety Belt Maintenance .....138

334

*2007 Escape Hybrid (ehv)  
Owners Guide (post-2002-fmt)  
USA (fus)*

## Index

- Safety belts (see Safety restraints) .....129, 133–137
  - Safety Canopy .....153, 155
  - Safety defects, reporting .....259
  - Safety restraints .....129, 133–137
    - belt minder .....139
    - extension assembly .....138
    - for adults .....134–136
    - for children .....158–159
    - Occupant Classification
    - Sensor .....131
    - safety belt maintenance .....138
    - warning light and chime .....138–139
  - Safety seats for children .....162
  - Safety Compliance Certification Label .....303
  - Scheduled Maintenance Guide .....307
    - General Maintenance Information .....307
    - Normal Scheduled Maintenance and Log .....311
    - Special Operating Conditions .....325
    - What Maintenance Schedule Should You Follow? .....310
  - Seat belts (see Safety restraints) .....129
  - Seats .....121
    - child safety seats .....162
    - heated .....124
  - SecuriLock passive anti-theft system .....117
  - Servicing your vehicle .....267
  - Setting the clock
    - AM/FM/In-dash 6 CD .....28, 32
    - AM/FM/Tape/CD .....21
  - Snowplowing .....10
  - Spark plugs, specifications .....299, 302
  - Special notice
    - ambulance conversions .....10
    - utility-type vehicles .....10
  - Specification chart, lubricants .....300
  - Speed control .....92
  - Starting your vehicle .....203, 205
    - jump starting .....244, 248
  - Steering wheel
    - tilting .....87
- T**
- Tilt steering wheel .....87
  - Tire Pressure Monitoring System (TPMS)
    - Tires, Wheels and Loading ....187
    - Warning Displays .....14
  - Tires .....172–173
    - alignment .....179
    - care .....176
    - changing .....235
    - checking the pressure .....176
    - inflating .....174
    - label .....186
    - replacing .....178
    - rotating .....180
    - safety practices .....179
    - sidewall information .....181
    - snow tires and chains .....191
    - spare tire .....233
    - terminology .....173
    - tire grades .....173
    - treadwear .....172, 177
  - Towing .....197
    - recreational towing .....202

## Index

- trailer towing .....197
- wrecker .....251
- Transmission .....210
  - brake-shift interlock (BSI) ....210
  - fluid, checking and adding (automatic) .....294
  - fluid, refill capacities .....300
  - lubricant specifications .....300
- Turn signal .....80
- V**
- Vehicle Identification Number (VIN) .....303
- Vehicle loading .....191
- Ventilating your vehicle .....206
- W**
- Warning lights (see Lights) .....14
- Washer fluid .....271
- Water, Driving through .....221
- Windows
  - power .....90
  - rear wiper/washer .....87
- Windshield washer fluid and wipers
  - checking and adding fluid ....271
  - liftgate reservoir .....271
  - operation .....86
  - replacing wiper blades .....272
- Wrecker towing .....251